

GDL Reference Guide

GRAPHISOFT®
A NEMETSCHek COMPANY

GRAPHISOFT®

Visit the GRAPHISOFT website at <https://www.graphisoft.com> for local distributor and product availability information.

GDL Reference Guide

Copyright© 2019 by GRAPHISOFT, all rights reserved. Reproduction, paraphrasing or translation without express prior written permission is strictly prohibited.

Trademarks

ARCHICAD® is a registered trademark and PlotMaker, Virtual Building and GDL are trademarks of GRAPHISOFT. All other trademarks are the property of their respective holders.

Introduction

This manual is a complete reference to the GRAPHISOFT's proprietary scripting language, GDL (Geometric Description Language). The manual is recommended for those users who wish to expand on the possibilities presented by the construction tools and object libraries in GRAPHISOFT software. It gives a detailed description of GDL, including syntax definitions, commands, variables, etc.

Table of Contents

General Overview	1
Starting Out	1
Scripting	1
3D Generation	8
GDL Syntax	11
Rules of GDL Syntax	11
Statements	11
Line	11
Label	11
Characters	11
Strings	12
Identifiers	12
Variables	12
Parameters	13
Simple Types	13
Derived Types	13
Structured Types	14
Conventions used in this book	14
Coordinate Transformations	16
2D Transformations	16
ADD2	16
MUL2	16
ROT2	17
3D Transformations	17
ADDX	17
ADDY	17
ADDZ	17
ADD	17
MULX	18
MULY	18

MULZ	18
MUL	18
ROTX	18
ROTY	18
ROTZ	19
ROT	19
XFORM	19
Managing the Transformation Stack	20
DEL	20
DEL TOP	20
NTR	20
3D Shapes	22
Basic Shapes	22
BLOCK	22
BRICK	22
CYLIND	23
SPHERE	23
ELLIPS	24
CONE	25
PRISM	25
PRISM_	26
CPRISM_	29
CPRISM_{2}	30
CPRISM_{3}	31
CPRISM_{4}	34
BPRISM_	34
FPRISM_	35
HPRISM_	37
SPRISM_	38
SPRISM_{2}	39
SPRISM_{3}	40
SPRISM_{4}	41
SLAB	42

SLAB_	42
CSLAB_	43
CWALL_	43
BWALL_	47
XWALL_	49
XWALL_{2}	51
XWALL_{3}	52
BEAM	55
CROOF_	55
CROOF_{2}	58
CROOF_{3}	59
CROOF_{4}	60
MESH	60
ARMC	62
ARME	63
ELBOW	64
Planar Shapes in 3D	65
HOTSPOT	65
HOTLINE	65
HOTARC	66
LIN_	66
RECT	66
POLY	66
POLY_	67
PLANE	68
PLANE_	68
CIRCLE	68
ARC	69
Shapes Generated from Polylines	69
EXTRUDE	71
PYRAMID	74
REVOLVE	76
REVOLVE{2}	81

REVOLVE{3}	82
REVOLVE{4}	84
REVOLVE{5}	84
RULED	84
RULED{2}	84
RULEDSEGMENTED	88
RULEDSEGMENTED{2}	89
SWEEP	90
TUBE	93
TUBE{2}	97
TUBEA	99
COONS	102
COONS{2}	105
MASS	105
MASS{2}	108
POLYROOF	109
POLYROOF{2}	114
POLYROOF{3}	114
POLYROOF{4}	117
EXTRUDED SHELL	117
EXTRUDED SHELL{2}	118
EXTRUDED SHELL{3}	120
REVOLVED SHELL	120
REVOLVED SHELL{2}	121
REVOLVED SHELL{3}	123
REVOLVED SHELL ANGULAR	123
REVOLVED SHELL ANGULAR{2}	124
REVOLVED SHELL ANGULAR{3}	124
RULED SHELL	125
RULED SHELL{2}	127
RULED SHELL{3}	130
Elements for Visualization	130
LIGHT	130

PICTURE	135
3D Text Elements	136
TEXT	136
RICHTEXT	137
Primitive Elements	137
VERT	138
VERT{2}	138
TEVE	139
VECT	139
EDGE	139
PGON	140
PGON{2}	141
PGON{3}	141
PIPG	141
COOR	141
COOR{2}	143
COOR{3}	144
BODY	146
BASE	149
NURBS Primitive Elements	150
NURBS Face trimming	151
NURBS Geometry Commands	151
NURBSCURVE2D	151
NURBSCURVE3D	152
NURBSSURFACE	153
NURBS Topology Commands	153
NURBSVERT	154
NURBSEDGE	154
NURBSTRIM	155
NURBSTRIMSINGULAR	155
NURBSFACE	156
NURBSFACE{2}	157
NURBSLUMP	157

NURBSBODY	158
Point Clouds	158
POINTCLOUD	158
Cutting in 3D	159
CUTPLANE	159
CUTPLANE{2}	159
CUTPLANE{3}	159
CUTPOLY	163
CUTPOLYA	165
CUTSHAPE	168
CUTFORM	168
CUTFORM{2}	170
Solid Geometry Commands	170
GROUP - ENDGROUP	174
ADDGROUP	175
SUBGROUP	175
ISECTGROUP	175
ISECTLINES	176
PLACEGROUP	176
KILLGROUP	176
SWEEPGROUP	177
CREATEGROUPWITHMATERIAL	179
Binary 3D	179
BINARY	179
2D Shapes	181
Drawing Elements	181
HOTSPOT2	181
HOTLINE2	181
HOTARC2	182
LINE2	182
RECT2	182
POLY2	182
POLY2_	183

POLY2_A	184
POLY2_B	185
POLY2_B{2}	185
POLY2_B{3}	186
POLY2_B{4}	186
POLY2_B{5}	186
POLY2_B{6}	187
ARC2	188
CIRCLE2	188
SPLINE2	189
SPLINE2A	190
PICTURE2	192
PICTURE2{2}	192
Text Element	192
TEXT2	192
RICHTEXT2	193
Binary 2D	193
FRAGMENT2	193
3D Projections in 2D	193
PROJECT2	193
PROJECT2{2}	194
PROJECT2{3}	197
PROJECT2{4}	198
Drawings in the List	201
DRAWING2	201
DRAWING3	201
DRAWING3{2}	201
DRAWING3{3}	201
Graphical Editing Using Hotspots	203
Status Codes	211
Status Code Syntax	211
Additional Status Codes	212
Previous part of the polyline: current position and tangent is defined	213

Segment by absolute endpoint	213
Segment by relative endpoint	213
Segment by length and direction	214
Tangential segment by length	214
Set start point	215
Close polyline	215
Set tangent	215
Set centerpoint	216
Tangential arc to endpoint	216
Tangential arc by radius and angle	217
Arc using centerpoint and point on the final radius	217
Arc using centerpoint and angle	218
Full circle using centerpoint and radius	218
Attributes	224
Directives	224
Directives for 3D and 2D Scripts	224
LET	224
RADIUS	224
RESOL	225
TOLER	226
PEN	227
LINE_PROPERTY	228
[SET] STYLE	228
Directives Used in 3D Scripts Only	228
MODEL	228
[SET] MATERIAL	229
[SET] BUILDING_MATERIAL	230
SECT_FILL	231
SECT_ATTRS	231
SECT_ATTRS {2}	231
SHADOW	231
Directives Used in 2D Scripts Only	233
DRAWINDEX	233

[SET] FILL	233
[SET] LINE_TYPE	233
Inline Attribute Definition	234
Materials	234
DEFINE MATERIAL	234
DEFINE MATERIAL BASED_ON	236
DEFINE TEXTURE	238
Fills	240
DEFINE FILL	240
DEFINE FILLA	243
DEFINE SYMBOL_FILL	246
DEFINE SOLID_FILL	247
DEFINE EMPTY_FILL	247
DEFINE LINEAR_GRADIENT_FILL	247
DEFINE RADIAL_GRADIENT_FILL	247
DEFINE TRANSLUCENT_FILL	247
DEFINE IMAGE_FILL	248
Line Types	248
DEFINE LINE_TYPE	248
DEFINE SYMBOL_LINE	249
Text Styles and Text Blocks	249
DEFINE STYLE	249
DEFINE STYLE{2}	250
PARAGRAPH	251
TEXTBLOCK	252
TEXTBLOCK_	253
Additional Data	253
External file dependence	254
FILE_DEPENDENCE	254
Non-Geometric Scripts	255
The Properties Script	255
DATABASE_SET	255
DESCRIPTOR	256

REF DESCRIPTOR	256
COMPONENT	256
REF COMPONENT	257
BINARYPROP	257
SURFACE3D	257
VOLUME3D	257
POSITION	257
DRAWING	258
The Parameter Script	259
VALUES	259
VALUES{2}	260
PARAMETERS	261
LOCK	261
HIDEPARAMETER	262
The User Interface Script	262
UI_DIALOG	263
UI_PAGE	263
UI_CURRENT_PAGE	264
UI_BUTTON	264
UI_PICT_BUTTON	265
UI_SEPARATOR	265
UI_GROUPBOX	265
UI_PICT	266
UI_STYLE	266
UI_OUTFIELD	266
UI_INFIELD	267
UI_INFIELD{2}	267
UI_INFIELD{3}	268
UI_INFIELD{4}	268
UI_CUSTOM_POPUP_INFIELD	276
UI_CUSTOM_POPUP_INFIELD{2}	276
UI_RADIOBUTTON	279
UI_RADIOBUTTON{2}	279

UI_PICT_RADIOBUTTON	280
UI_PICT_RADIOBUTTON{2}	280
UI_PICT_PUSHCHECKBUTTON	280
UI_PICT_PUSHCHECKBUTTON{2}	280
UI_TEXTSTYLE_INFIELD	281
UI_TEXTSTYLE_INFIELD{2}	281
UI_LISTFIELD	282
UI_LISTITEM	282
UI_LISTITEM{2}	283
UI_CUSTOM_POPUP_LISTITEM	284
UI_CUSTOM_POPUP_LISTITEM{2}	285
UI_TOOLTIP	287
UI_COLORPICKER	288
UI_COLORPICKER{2}	288
UI_SLIDER	289
UI_SLIDER{2}	289
The Forward Migration Script	289
SETMIGRATIONGUID	290
STORED_PAR_VALUE	291
DELETED_PAR_VALUE	291
The Backward Migration Script	291
NEWPARAMETER	293
Expressions and Functions	294
Expressions	294
DICT	294
HASKEY	299
REMOVEKEY	299
DIM	300
VARDIM1	301
VARDIM2	301
PARVALUE_DESCRIPTION	304
Operators	304
Arithmetical Operators	304

Relational Operators	305
Boolean Operators	305
Functions	306
Arithmetical Functions	306
ABS	306
CEIL	306
INT	306
FRA	306
ROUND_INT	306
SGN	306
SQR	306
Circular Functions	307
ACS	307
ASN	307
ATN	307
COS	307
SIN	307
TAN	307
PI	307
Transcendental Functions	308
EXP	308
LGT	308
LOG	308
Boolean Functions	308
NOT	308
Statistical Functions	308
MIN	308
MAX	308
RND	309
Bit Functions	309
BITTEST	309
BITSET	309
Special Functions	309

REQ	309
REQUEST	310
IND	310
APPLICATION_QUERY	311
LIBRARYGLOBAL	311
String Functions	311
STR	311
STR{2}	312
SPLIT	315
STW	316
STRLEN	316
STRSTR	317
STRSUB	317
STRTOUPPER	318
STRTOLOWER	318
Control Statements	319
Flow Control Statements	319
FOR - TO - NEXT	319
DO - WHILE	320
WHILE - ENDWHILE	320
REPEAT - UNTIL	321
IF - GOTO	322
IF - THEN - ELSE - ENDIF	323
GOTO	324
GOSUB	324
RETURN	324
END / EXIT	325
BREAKPOINT	325
Parameter Buffer Manipulation	325
PUT	326
GET	326
USE	326
NSP	326

Macro Objects	329
CALL	329
Output in an Alert Box or Report Window	331
PRINT	331
File Operations	331
OPEN	332
INPUT	332
VARTYPE	332
OUTPUT	332
CLOSE	333
Using Deterministic Add-Ons	333
INITADDONSCOPE	333
PREPAREFUNCTION	333
CALLFUNCTION	333
CLOSEADDONSCOPE	334
Miscellaneous	335
Global Variables	335
Script compatibility	335
General environment information	336
Story information	341
Fly-through information	341
General element parameters	343
Object, Lamp, Door, Window, Wall End, Skylight parameters	344
Object, Lamp, Door, Window, Wall End, Skylight, Curtain Wall Accessory parameters - available for listing and labels only	345
Object, Lamp, Curtain Wall Accessory parameters - available for listing and labels only	345
Opening parameters - available for listing and labels only	345
Opening symbol parameters	347
Window, Door and Wall End parameters	350
Window, Door parameters - available for listing and labels only	351
Lamp parameters - available for listing and labels only	352
Marker parameters (Detail, Worksheet and Change Markers)	352
Label parameters	353

Wall parameters - available for Doors/Windows, listing and labels	354
Wall parameters - available for listing and labels only	357
Column parameters - available for listing and labels only	359
Beam parameters - available for listing and labels only	365
Slab parameters - available for listing and labels only	370
Stair component parameters	373
General stair variables - available for listing and labels	373
General tread variables - available for listing and labels	375
General riser variables - available for listing and labels	376
Stair structure variables - available for listing and labels	377
Stair Model View Options variables	377
Stair 2D variables - available for floor plan representation only	378
Stair grid variables	379
Stair walking line symbol variables	382
Stair break mark symbol variables	384
Rise and Run description variables	385
Stair draining 2D variables	385
Stair structure 2D variables - Beam Structures	387
Stair structure 2D variables - Monolithic Structure	388
General 2D related variables	392
Stair 3D variables - available for 3D representation (and connecting viewpoints) only	395
Stair riser 3D variables	395
Stair tread 2D-3D variables	396
Stair structure variables	399
Railing component parameters	401
General railing variables - available for listing and labels	401
Railing 3D variables	402
Railing 2D variables	408
Roof parameters - available for skylights, listing and labels	412
Roof parameters - available for listing and labels only	415
Fill parameters - available for listing and labels only	416
Mesh parameters - available for listing and labels only	417
Curtain Wall component parameters	418

Curtain Wall parameters - available for listing and labels only	420
Curtain Wall Frame parameters	421
General Curtain Wall Frame variables - available for listing and labels only	421
Curtain Wall Frame 3D variables	421
Curtain Wall Panel variables	423
Curtain Wall Panel parameters - available for listing and labels only	424
Curtain Wall Junction parameters - available for listing and labels only	424
Curtain Wall Accessory parameters - available for listing and labels only	425
Migration parameters - available for migration scripts only	425
Skylight parameters - available for listing and labels only	425
Common Parameters for Shells and Roofs - available for listing and labels only	425
Parameters for Morphs - available for listing and labels only	430
Free users' globals	431
Example usage of global variables	432
Deprecated Global Variables	432
Deprecated Beam/Column Global Variables - available for listing and labels only	433
Deprecated Label Global Variables	433
Deprecated Curtain Wall Frame Global Variable - available for listing and labels only	435
Old Global Variables	435
Fix named optional parameters	437
Parameters set by ARCHICAD	437
Parameters for D/W attributes (available for Door, Window, Label, Listing)	438
Floor plan display	438
Direction	438
Polygonal wall data	439
Hole position	439
Anchor data	439
Parameters for WALL attributes (available for Door, Window, Label, Listing)	439
Floor plan display	439
Geometric data	440
Parameters for COLUMN attributes (available for Label, Listing)	440
Floor plan display	441
Geometric data	442

Parameters for BEAM attributes (available for Label, Listing)	442
Floor plan display	442
Geometric data	443
Parameters for ROOF attributes (available for Label, Listing)	444
Floor plan display	444
Door/Window Marker attributes	444
Detail/Worksheet Marker attributes	446
Drawing Title attributes	446
General running context	447
Room parameters (available for Zone Stamps)	448
Stair related parameters	450
Flight / Landing Side Supported subtypes	450
Riser Component subtype	450
Stair 2D Component subtypes	450
Parameters set/read by ARCHICAD	450
Stair related parameters	450
Structure subtype	450
Parameters read by ARCHICAD	451
Objects on Floor Plan	451
Floor plan cutting of planar elements (i.e. skylight object, roof accessory objects)	451
Door/Window objects	452
Custom Component Template	453
Stair related parameters	453
Structure subtype	453
Flight / Landing Under Supported subtype	453
Flight Under Supported Cantilever / Landing Cantilever Supported subtypes	454
Railing related parameters	454
Railing Panel Component subtype	454
Railing Rail Component subtype	454
Railing Post Component subtype	455
Railing End Component subtype	456
Parameters for Curtain Wall	456
Curtain Wall Parameters set and read by ARCHICAD	457

Curtain Wall Frame parameters	457
Curtain Wall Parameters set by ARCHICAD	457
Curtain Wall Frame parameters	457
Curtain Wall Panel parameters	458
Curtain Wall Junction parameters	458
Curtain Wall Accessory parameters	458
Curtain Wall Frame Deprecated parameters	459
Curtain Wall Parameters read by ARCHICAD	460
Curtain Wall Panel and Frame parameters	460
Curtain Wall Frame parameters	461
Curtain wall panel parameters	462
Parameters for add-ons	463
Parameters of Skylight add-on	463
Hole edge cut manipulation	463
Parameters of Corner Window add-on	463
Basic parameters of Corner Window objects	463
Wall skins data parameters of Corner Window objects (available from ARCHICAD 12)	464
Parameters of IFC add-on	464
Common basic parameters of Door and Window objects	464
Basic parameters of Door objects	466
Basic parameters of Window objects	469
Basic parameters of Transport Elements	472
Basic parameters of Lift objects	472
Basic parameters of Stair objects	473
Basic parameters of MEP elements	475
Parameters for Text Handling	476
Parameters for Labels	477
Parameters set or read by ARCHICAD	477
Parameters read by ARCHICAD	479
Deprecated parameters	480
Deprecated Beam/Column parameters - available for listing and labels only	480
Deprecated Zone Stamp parameters	481
REQUEST Options	481

Request Parameter Script Compatibility	481
Details of Requests	487
Profile Requests	509
Deprecated Requests	512
Application Query Options	512
Document feature	513
View direction	513
MEP System	513
Get MEP Systems	513
Get Domain	513
Get Contour Pen	514
Get Fill Pen	514
Get Background Pen	514
Get Fill Type	514
Get Center Line Type	515
Get Center Line Pen	515
Get System Material	515
Get Insulation Material	515
MEP Modeler	516
Is Available	516
MEP Connection Type	516
Get Connection Types	516
Get Connection Type Style	516
MEP Flexible Segment	517
Start Sectioning	517
Add Control Point	517
Add Direction and Width Vector	517
End Sectioning	518
MEP Bend	518
Start Sectioning	518
Parameter Script	519
First Occasion in Progress	519
Tags and Categories	519

Get Parameter Folder Names	519
Get Parameter Names	520
Get Parameters	520
Library manager	520
Ies files	520
User image files	520
GDL Style Guide	521
Introduction	521
Naming Conventions	521
General rules	521
Variable names	521
Capitalization	523
Expressions	523
Control flow statements	524
if - else - endif	524
for - next, do - while, while - endwhile, repeat - until	525
Subroutines	525
Writing comments	526
Script header	526
Section divide	527
Script structure	529
Bad Solution	530
Good Solution	531
Basic Technical Standards	531
Introduction	531
Library part format	532
File extension	532
Identification	532
General scripting issues	535
Numeric types - Precision	535
Trigonometry functions	537
GDL warnings	537
Hotspot and Hotline IDs	539

Purpose of hotspot/hotline/hotarc identification	539
Problem of old-school hotspots/hotlines	539
Correct hotspot/hotline/hotarc scripting	540
Editable hotspots	540
Editable hotspot example - Shoe / Shoe-rack	540
GDL execution contexts	542
Communicating values with ARCHICAD	543
Information flow from ARCHICAD	544
Global variables	544
Fix named optional parameters	544
Requests and Application Queries	544
Information coming from the library part	544
Model View Options, Library Global	544
Internal Model View Options	545
Library Global View Options	545
Script type specific issues	545
Master script	545
2D script	546
Execution context	546
General recommendation	546
Defining line and fill properties	546
3D script	547
Execution context	547
General recommendation	548
Modeling transparent bodies	548
Texture mapping	550
Picture elements	556
Group operations	557
Parameter script	558
Execution context	558
General recommendation	558
Font type names	559
Setting limits for array parameters	559

User Interface script	560
Execution context	560
General recommendation	560
Thumbnail control pictures	560
Tab page handling	561
Thumbnail controls with dynamic items	564
Transparent UI pictures	566
Font sizes on the UI	566
Forward Migration script	567
Execution context	567
General recommendation	568
Backward Migration script	569
Execution context	569
General recommendation	570
Migration table	571
Writing macros	572
Macro return parameters	572
Advanced parameters all	572
Faster macro call	572
Macro call example	573
Background Conversion Issues	573
Speed Issues	574
Windows-Macintosh compatibility	574
Changing platform with binary libraries	575
Images and HDPI support in GDL	575
Doors and Windows	576
General Guidelines	576
Positioning	577
Creation of Door/Window Library Parts	579
Rectangular Doors/Windows in Straight Walls	580
3D Related Challenges	582
Non-Rectangular Doors/Windows in Straight Walls	582
WALLHOLE	582

WALLNICHE	585
Rectangular Doors/Windows in Curved Walls	586
Non-Rectangular Doors/Windows in Curved Walls	588
2D Related Challenges	591
Cutting custom wall opening	591
WALLHOLE2	591
WALLHOLE2{2}	592
Extending the wall polygon	593
WALLBLOCK2	593
WALLBLOCK2{2}	593
WALLLINE2	593
WALLARC2	593
GDL Created from the Floor Plan	594
Keywords	594
Common Keywords	594
Reserved Keywords	597
3D Use Only	597
2D Use Only	603
2D and 3D Use	605
Non-Geometric Scripts	605
Properties Script	605
Parameter Script	606
Interface Script	606
Forward and Backward Migration Scripts	608
GDL Data I/O Add-On	608
Description of Database	608
Opening a Database	608
Reading Values from Database	609
Writing Values into Database	610
Closing Database	611
GDL Datetime Add-On	611
Opening Channel	611
Reading Information	613

Closing Channel	613
GDL File Manager I/O Add-On	613
Specifying Folder	613
Getting File/Folder Name	614
Finishing Folder Scanning	614
GDL Text I/O Add-On	615
Opening File	615
Reading Values	616
Writing Values	617
Closing File	617
Property GDL Add-On	618
Open property database	618
Close property database	619
Input to property database	619
Output to property database	622
GDL XML Extension	622
Opening an XML Document	623
Reading an XML Document	624
Modifying an XML Document	628
Polygon Operations Extension	632
Opening a channel	632
Container management	633
CreateContainer	633
DeleteContainer	633
EmptyContainer	633
SetSourceContainer	633
SetDestinationContainer	633
Polygon / polyline management	633
Array	633
Dictionary	634
Store	634
StorePolyline	635
StoreDictPolygon	636

StoreDictPolyline	636
Dispose	636
Polygon / polyline operation settings	636
HalfPlaneParams	636
OffsetParams	637
MultipleEdgeOffsetParams	637
PolylineOffsetVectors	637
Polygon / polyline operations	637
+ - /	638
ClipPolyline	638
CopyPolygon	638
Regularize	638
PolyCut	639
OffsetEdge	639
OffsetMultipleEdges	639
OffsetPolyline	639
OffsetPolylineWithVectors	640
ResizeContour	640
CentreOfGravity	640
Get resulting polygons / polylines	640
Array	640
GetSourcePolygons, GetSourcePolylines	640
GetDestinationPolygons, GetDestinationPolylines	640
GetVertices, GetPolylineVertices	641
GetContourEnds	641
GetInhEdgeInfos, GetPolylineInhEdgeInfos	641
Dictionary	641
GetSourceDictPolygon, GetSourceDictPolyline	641
GetDestinationDictPolygon, GetDestinationDictPolyline	642
Closing channel	642
Autotext Guide	642
Project info keywords	642
General	643

Layout autotexts	644
Drawing autotexts	644
Reference type autotexts	644
Marker type autotexts	645
Change related autotexts	645
Layout revision related autotexts	645
New GDL Features in ARCHICAD 23	646
New data type: dictionary	646
New functions in PolyOperations add-on	646
New tool: Opening	647
Updated tools: Beam and Column	647
New Property requests	648
Diagnostics mode	648
Command updates and extended versions	649
IFC4	649
New source format with LP_XMLConverter	650
Index	651
Syntax Listing of GDL Commands	651

GENERAL OVERVIEW

GDL is a parametric **programming language**, similar to BASIC. It describes 3D solid objects like doors, windows, furniture, structural elements, stairs, and the 2D symbols representing them on the floor plan. These objects are called **library parts**.

STARTING OUT

The needs of your design, your background in programming and your knowledge of descriptive geometry will all probably influence where you start in GDL.

Do not start practicing GDL with complicated objectives in mind. Rather, try to learn GDL through experimenting step by step with all of its features to best utilize them to your advantage. Follow the expertise level recommendations below.

If you are familiar with a programming language like BASIC, you can get acquainted with GDL by observing existing scripts. You can also learn a lot by opening the library parts shipped with your software and taking a look at the 2D and 3D GDL scripts. Additionally, you can save floor plan elements in GDL format and see the resulting script.

If you are not familiar with BASIC, but have played with construction blocks, you can still find your way in GDL through practice. We advise trying the simplest commands right away and then checking their effect in the 3D window of the library part.

Several books and materials have been published on GDL and object library development.

- “*Object Making with ARCHICAD*” is the perfect guide for beginners.
- “*Creating GDL Objects*” e-Guide gives a basic overview of the object creation methods.
- David Nicholson Cole’s “*GDL Cookbook*” is the most popular course book for entry level and advanced GDL programmers for a long time.
- A more recent learning material is “*GDL Handbook*” by Andrew Watson for novice and experienced users as well.
- “*GDL Advanced Technical Standards*” contains GRAPHISOFT’s official standards for professional library developers; this document can be downloaded after registration from GRAPHISOFT’s website: <https://www.graphisoft.com/support/developer/>. For guidelines of basic development, see the section called “Basic Technical Standards” in this manual.

SCRIPTING

Library Part Structure

Every library part described with GDL has **scripts**, which are lists of the actual GDL commands that construct the 3D shape and the 2D symbol. Library parts also have a description for quantity calculations.

Master script commands will be executed before each script.

The **2D script** contains parametric 2D drawing description. The binary **2D data** of the library part (content of the 2D symbol window) can be referenced using the FRAGMENT2 command. If the 2D script is empty, the binary 2D data will be used to display the library part on the floor plan.

The **3D script** contains a parametric 3D model description. The binary **3D data** (which is generated during an import or export operation) can be referenced using the BINARY command.

The **Properties script** contains components and descriptors used in element, component and zone lists. The **binary properties data** described in the **components** and **descriptors** section of the library part can be referenced using the BINARYPROP command. If the properties script and the master script are empty, the binary properties data will be used during the list process.

The **User Interface script** allows the user to define input pages that can be used to edit the parameter values in place of the normal parameter list.

In the **Parameter script**, sets of possible values can be defined for the library part parameters.

The parameter set in the **Parameters** section are used as defaults in the library part settings when placing the library part on the plan.

In the **Forward Migration script** you can define the conversion logic which can convert placed instances of older elements.

In the **Backward Migration script** you can define a backward conversion to an older version of an element.

The **Preview picture** is displayed in the library part settings dialog box when browsing the active library. It can be referenced by the PICTURE and PICTURE2 commands from the 3D and 2D script.

ARCHICAD provides a helpful environment to write GDL scripts, with on-the-fly visualization, syntax and error checking.

Analyze, Deconstruct and Simplify

No matter how complex, most objects you wish to create can be broken down into building blocks of simple geometric shapes. Always start with a simple analysis of the desired object and define all the geometric units that compose it. These building blocks can then be translated into the vocabulary of the GDL scripting language. If your analysis was accurate, the combination of these entities will form the desired object. To make the analysis, you need to have a good perception of space and at least a basic knowledge of descriptive geometry.

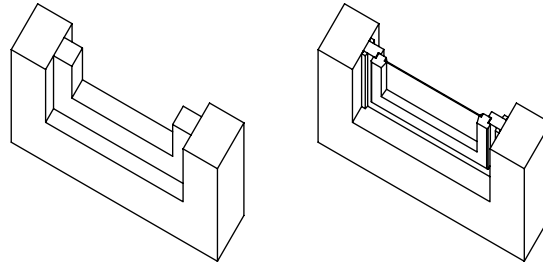

Window representations with different levels of sophistication

To avoid getting discouraged early on in the learning process, start with objects of defined dimensions and take them to their simplest but still recognizable form. As you become familiar with basic modeling, you can increase the level of sophistication and get closer to the ideal form. *Ideal* does not necessarily mean complicated. Depending on the nature of the architectural project, the ideal library part could vary from basic to refined. The window on the left in the above illustration fits the style of a design visualization perfectly. The window on the right gives a touch of realism and detail which can be used later in the construction documents phase of the project.

Elaboration

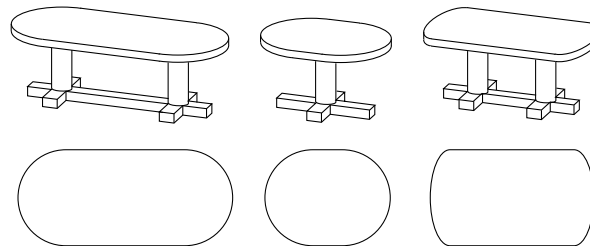

Depending on your purpose, your custom parametric objects may vary in elaboration. Custom objects for internal studio use may be less refined than the ones for general use or for commercial distribution.

If your symbols have little significance on the floor plan, or if parametric changes do not need to appear in 2D, then you can omit parametric 2D scripts.

Even if parametric changes are intended to be present in 2D, it is not absolutely necessary to write a parametric 2D script. You can perform parametric modifications in the 3D Script window or use the 3D top view of the modified object as a new symbol and save the modified object under a new name. Parametric changes to the default values will result in several similar objects derived from the original.

The most complex and sophisticated library parts consist of parametric 3D descriptions with corresponding parametric 2D scripts. Any changes in the settings will affect not only the 3D image of the object, but also its floor plan appearance.

Entry Level

These commands are easy to understand and use. They require no programming knowledge, yet you can create very effective new objects using only these commands.

Simple Shapes

Shapes are basic geometric units that add up to a complex library part. They are the construction blocks of GDL. You place a shape in the 3D space by writing a command in the GDL script.

A shape command consists of a keyword that defines the shape type and some numeric values or alphabetic parameters that define its dimensions. The number of values varies by shape.

In the beginning, you can omit using parameters and work with fixed values only.

You can start with the following shape commands:

In 3D:

BLOCK, CYLIND, SPHERE, PRISM

In 2D:

LINE2, RECT2, POLY2, CIRCLE2, ARC2

Coordinate Transformations

Coordinate transformations are like moving your hand to a certain place before placing a construction block. They prepare the position, orientation and scale of the next shape.

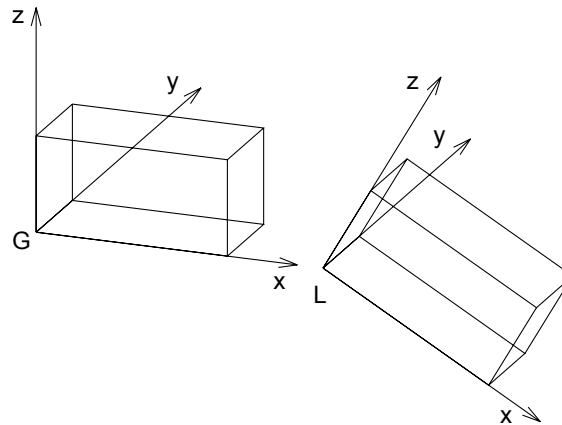

```
BLOCK 1, 0.5, 0.5
ADDX 1.5
ROTY 30
BLOCK 1, 0.5, 0.5
```

The 3D window of the library part will optionally show you the home (G = global) and the current (L = local) position of the coordinate system for any object present.

The simplest coordinate transformations are as follows:

In 3D:

```
ADDX, ADDY, ADDZ, ROTX, ROTY, ROTZ
```

In 2D:

```
ADD2, ROT2
```

The commands starting with ADD will move the next shape, while the ROT commands will turn it around any of its axes.

Intermediate Level

These commands are a bit more complex, not because they expect you to know programming, but simply because they describe more complex shapes or more abstract transformations.

In 3D:

```
ELLIPS, CONE
```

POLY_, LIN_, PLANE, PLANE_
 PRISM_, CPRISM_, SLAB, SLAB_, CSLAB_, TEXT

In 2D:

HOTSPOT2, POLY2_, TEXT2, FRAGMENT2

These commands usually require more values to be defined than the simple ones. Some of them require status values to control the visibility of edges and surfaces.

Coordinate Transformations**In 3D:**

On top of the entry level transformations

MULX, MULY, MULZ, ADD, MUL, ROT

In 2D:

On top of the entry level transformations

MUL2

Example:

```
PRISM 4, 1, 3, 0,
      3, 3,
      -3, 3,
      -3, 0
ADDZ -1
MUL 0.666667, 0.666667, 1
PRISM 4, 1, 3, 0,
      3, 3,
      -3, 3,
      -3, 0
ADDZ -1
MUL 0.666667, 0.666667, 1
PRISM 4, 1, 3, 0,
      3, 3,
      -3, 3,
      -3, 0
```

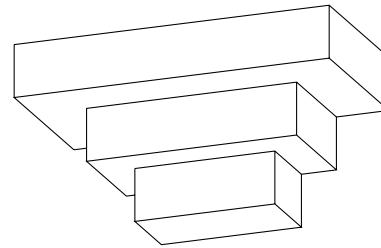

The transformations starting with MUL will rescale the subsequent shapes by distorting circles into ellipses or spheres into ellipsoids. If used with negative values, they can be used for mirroring. The commands in the second row affect all three dimensions of space at the same time.

Advanced Level

These commands add a new level of complexity either because of their geometric shape, or because they represent GDL as a programming language.

In 3D:

BPRISM_	BWALL_	CWALL_	XWALL_
CROOF_	FPRISM_	SPRISM_	
EXTRUDE	PYRAMID	REVOLVE	RULED
SWEEP	TUBE	TUBEA	COONS
MESH	MASS		
LIGHT	PICTURE		

There are shape commands in this group which let you trace a spatial polygon with a base polygon to make smooth curved surfaces. Some shapes require material references in their parameter list.

By using cutting planes, polygons and shapes, you can generate complex arbitrary shapes out of simple shapes. The corresponding commands are CUTPLANE, CUTPOLY, CUTPOLYA, CUTSHAPE and CUTEND.

In 2D:

PICTURE2, POLY2_A, SPLINE2, SPLINE2A

Flow Control and Conditional Statements

FOR - TO - NEXT

DO - WHILE, WHILE - ENDWHILE

REPEAT - UNTIL

IF - THEN - ELSE - ENDIF

GOTO, GOSUB

RETURN, END / EXIT

These commands should be familiar to anyone who has ever programmed a computer, but they are basic enough that you can understand them without prior programming experience.

They let you make repetitive script parts to place several shapes with little scripting, or let you make decisions based on prior calculations.

```

FOR i = 1 TO 5
  PRISM_ 8, 0.05,
    -0.5, 0, 15,
    -0.5, -0.15, 15,
    0.5, -0.15, 15,
    0.5, 0, 15,
    0.45, 0, 15,
    0.45, -0.1, 15,
    -0.45, -0.1, 15,
    -0.45, 0, 15
  ADDZ 0.2
NEXT i

```

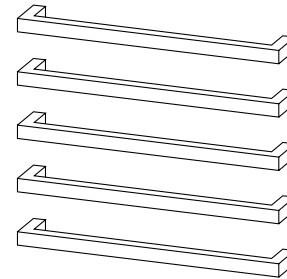

Parameters

At this stage of your expertise, you can replace fixed numeric values with variable names. This makes the object more flexible. These variables are accessible from the library part's Settings dialog box while working on the project.

Macro Calls

You are not limited to the standard GDL shapes. Any existing library part may become a GDL shape in its entirety. To place it, you simply call (refer to) its name and transfer the required parameters to it, just as with standard shape commands.

Expert Level

By the time you have a good understanding of the features and commands outlined above, you will be able to pick up the few remaining commands that you may need from time to time.

Note

The memory capacity of your computer may limit the file length of your GDL scripts, the depth of macro calls and the number of transformations.

You will find additional information on the above GDL commands throughout the manual. HTML format help files are also available with your software, giving a quick overview of the available commands and their parameter structure.

3D GENERATION

3D modeling is based on floating point arithmetics, meaning that there is no limit imposed on the geometric size of the model. Whatever size it is, it retains the same accuracy down to the smallest details.

The 3D model that you finally see on the screen is composed of geometric primitives. These primitives are stored in the memory of your computer in binary format, and the 3D engine generates them according to the floor plan you created. The metamorphosis between the architectural floor plan elements and the binary 3D data is called 3D conversion.

The primitives are the following:

- all the **vertices** of your building components
- all the **edges** linking the vertices
- all the surface **polygons** within the edges

Groups of these primitives are kept together as bodies. The bodies make up the 3D model. All of the features of 3D visualization - smooth surfaces, cast shadows, glossy or transparent materials - are based on this data structure.

The 3D Space

The 3D model is created in three-dimensional space measured by the x, y and z axes of a master coordinate system whose origin is called the **global origin**.

In Floor Plan view, you can see the global origin in the lower left corner of the worksheet if you open the program without reading a specific document. In addition, the global origin defines the zero level of all the stories referred to in a floor plan document.

When you place an object into the design, the floor plan position will define its location along the x and y axes of this master coordinate system. The location along the z axis can be set in the Object Settings dialog box or directly adjusted when placed in 3D. This location will be the base and the default position of the **local coordinate system** of the object. The shapes described in the script will be positioned with reference to this local coordinate system.

Coordinate Transformations

Every GDL shape is linked to the current position of the local coordinate system. For example, blocks are linked to the origin. The length, width and height of the block are always measured in a positive direction along the three axes. Thus, the BLOCK command requires only three parameters defining its dimensions along the axes.

How can you generate a shifted and rotated block? With the parameter structure of the BLOCK there is no way to do this. It does not have parameters for shift and rotation.

The answer is to move the coordinate system to the correct position before issuing the BLOCK command. With the coordinate transformation commands, you can pre-define its position and rotation around the axes. These transformations are not applied to the shapes already generated and are only effective on subsequent shapes.

The GDL Interpreter

When a GDL script is executed, the GDL interpreter engine will detect the location, size, rotation angle, user defined parameters and the mirrored state of the library part. It will then move the local coordinate system to the right position, ready to receive the GDL commands

from the script of the library parts. Every time a command for a basic shape is read by the interpreter, it will generate the geometric primitives that make up that particular shape.

When the interpreter has finished, the complete binary 3D model will be stored in the memory, and you can perform 3D projections, fly-through renderings or sun studies on it.

ARCHICAD contains a pre-compiler and an interpreter for GDL. Interpretation of a GDL script uses the pre-compiled code. This feature increases speed of the analysis. If the GDL script is modified, a new code is generated.

Data structures converted from other file formats (e.g., DXF, Zoom, Alias Wavefront) are stored in a binary 3D section of the library parts. This section is referenced by the BINARY command from the GDL script.

The GDL Script Analysis

Users have no control over the order in which library parts placed on the floor plan are analyzed. The order of GDL script analysis is based on the internal data structure; moreover, Undo and Redo operations as well as modifications may influence that order. The only exceptions to this rule are special GDL scripts of the active library, whose names begin with "**MASTER_GDL**" or "**MASTEREND_GDL**".

Scripts whose name begins with "**MASTER_GDL**" are executed before starting a list process and after loading the active library.

Scripts whose name begins with "**MASTEREND_GDL**" are executed when the active library is to be changed (Load Libraries, Open a project, New project, Quit).

These scripts are not executed when you edit library parts. If your library contains one or more such scripts they will all be executed in an order that is not defined.

MASTER_GDL and MASTEREND_GDL scripts can include attribute definitions, initializations of GDL user global variables, 3D commands (effective only in the 3D model), value list definitions (see the VALUES command) and GDL extension-specific commands. The attributes defined in these scripts will be merged into the current attribute set (attributes with same names are not replaced, while attributes originated from GDL and not edited in the program are always replaced).

GDL SYNTAX

This chapter presents the basic elements of GDL syntax, including statements, labels, identifiers, variables and parameters. Typographic rules are also explained in detail.

RULES OF GDL SYNTAX

GDL is not case sensitive; uppercase and lowercase letters are not distinguished, except in strings placed between quotation marks. The logical end of a GDL script is denoted by an END / EXIT statement or the physical end of the script.

STATEMENTS

A GDL program consists of statements. A statement can start with a keyword (defining a GDL shape, coordinate transformations or program control flow), with a macro name, or with a variable name followed by an '=' sign and an expression.

LINE

The statements are in lines separated by line-separators (end_of_line characters).

A comma (,) in the last position indicates that the statement continues on the next line. A colon (:) is used for separating GDL statements in a line. After an exclamation mark (!) you can write any comment in the line. Blank lines can be inserted into a GDL script with no effect at all. Any number of spaces or tabs can be used between the operands and operators. The use of a space or tab is obligatory after statement keywords and macro calls.

LABEL

Any line can start with a label which is used as a reference for a subsequent statement. A label is an integer number or a constant string between quotation marks, followed by a colon (:). A string label is case sensitive. Labels are checked for single occurrence. The execution of the program can be continued from any label by using a GOTO or GOSUB statement.

CHARACTERS

The GDL text is composed of the lower and uppercase letters of the English alphabet, any number and the following characters:

<space> _ (underline) ~ ! : , ; . + - * / ^ = < > <= >= # () [] { } \ @ & | (vertical bar) " ' ` ´ ` " ´ ` <end_of_line>

STRINGS

Any string of Unicode characters that is placed between quotation marks ("', “, ’, ` , `), or any string of characters without quotation marks that does not figure in the script as an identifier with a given value (macro call, attribute name, file name). Strings without quotation marks will be converted to all caps, so using quotation marks is recommended. The maximum length allowed in a string is 255 characters.

The '\ ' character has special control values. Its meaning depends on the next character.

\\	'\ ' char itself
\n	new line
\t	tabulator
\ <i>new line</i>	continue string in next line without a new line
\others	not correct, results in warning

Example:

```
"This is a string"
`washbasin 1'-6"*1'-2`
'Do not use different delimiters'
```

IDENTIFIERS

Identifiers are special ASCII character strings:

- they are not longer than 255 characters;
- they begin with a letter of the alphabet or a '_' or '~' character;
- they consist of ASCII letters, numbers and '_' or '~' characters;
- upper- and lowercase letters are considered identical.

Identifiers can be GDL keywords, global or local variables or strings (names). Keywords and global variable names are determined by the program you're using GDL in; all other identifiers can be used as variable names.

VARIABLES

GDL programs can handle numeric and string variables (defined by their identifiers), numbers and character strings.

There are two sets of variables: local and global.

All identifiers that are not keywords, global variables, attribute names, macro names or file names are considered local variables. If left uninitialized (undefined), their value will be 0 (integer). Local variables are stacked with macro calls. When returning from a macro call, the interpreter restores their values.

Global variables have reserved names (*for the list of global variables see the section called "Global Variables"*). They are not stacked during macro calls, enabling the user to store special values of the modeling and to simulate return codes from macros. The user global variables can be set in any script but they will only be effective in subsequent scripts. If you want to make sure that the desired script is analyzed first, set these variables in the MASTER_GDL library part. All elements will always read these values set by the Master GDL first, unless their own scripts (caller object or called macro) modify those values. There is no user global data exchange between the different interpretation instances. The other global variables can be used in your scripts to communicate with the program. By using the "=" command, you can assign a numeric or string value to local and global variables.

PARAMETERS

Identifiers listed in a library part's parameter list are called parameters. Parameter identifiers must not exceed 31 characters in length. And the maximum number of parameters must not exceed 1024. Within a script, the same rules apply to parameters as to local variables.

Parameters of text-only GDL files are identified by letters A to Z.

SIMPLE TYPES

Variables, parameters and expressions can be of two simple types: numeric or string.

Numeric expressions are constant numbers, numeric variables or parameters, functions that return numeric values, and any combination of these in operations. Numeric expressions can be integer or real. Integer expressions are integer constants, variables or parameters, functions that return integer values, and any combination of these in operations which results in integers. Real expressions are real constants, variables or parameters, functions that return real values, and any combination of these (or integer expressions) in operations which results in reals. A numeric expression being an integer or a real is determined during the compilation process and depends only on the constants, variables, parameters and the operations used to combine them. Real and integer expressions can be used the same way at any place where a numeric expression is required, however, in cases where a combination of these may result in precision problems, a compiler warning appears (comparison of reals or reals and integers using relational operators '=' or '<>', or boolean operators AND, OR, EXOR; IF or GOTO statements with real label expressions).

String expressions are constant strings, string variables or parameters, functions that return strings, and any combination of these in operations which result in strings.

DERIVED TYPES

Variables and parameters can also be arrays, and parameters can be value lists of a simple type.

Arrays are one- or two-dimensional tables of numeric and/or string values, which can be accessed directly by indexes.

Value lists are sets of possible numeric or string values. They can be assigned to the parameters in the value list script of the library part or in the MASTER_GDL script, and will appear in the parameter list as a pop-up menu.

STRUCTURED TYPES

Variables and parameters can also be dictionaries. *Compatibility: introduced in ARCHICAD 23.*

Dictionaries are a hierarchical collection of key and value pairs. Keys can contain other dictionary, array, integer, string or floating-point type values.

Keys are considered identifiers (the section called “Identifiers”) - same syntax rules apply, except the '~' character is not allowed.

It is not allowed to use dictionary keys (even if they are simple type) in the following places:

- as FOR - TO - NEXT loop variable.
- as HOTSPOT2 or HOTSPOT edited or displayed parameter.
- as UI_... input parameter where the input parameter is given as an expression. (UI_INFIELD{2}, UI_INFIELD{3}, UI_CUSTOM_POPUP_INFIELD{2}, UI_RADIOBUTTON, UI_PICT_RADIOBUTTON, UI_PICT_PUSHCHECKBUTTON, UI_TEXTSTYLE_INFIELD, UI_LISTITEM{2}, UI_CUSTOM_POPUP_LISTITEM{2}, UI_COLORPICKER{2}, UI_SLIDER{2})
- as UI_... input parameter where the input parameter is given as a string, if the string evaluates to a dictionary type parameter.
- as VALUES or VALUES { 2 } parameter - value lists cannot be applied.
- as REQUEST returned values - only root level of a dictionary is allowed in requests that support it.
- as APPLICATION_QUERY, SPLIT, INPUT, LIBRARYGLOBAL or CALLFUNCTION returned values.
- as STR{ 2 } returned extra_accuracy_string.
- as RETURNED_PARAMETERS of a CALL - only returned dictionaries can be stored only at the root level of a dictionary.

CONVENTIONS USED IN THIS BOOK

[aaa]

Square brackets mean that the enclosed elements are optional (if they are bold, they must be entered as shown).

{n}

command version number

...

Previous element may be repeated

|

Exclusive or relation between parameters of a command

variable

Any GDL variable name

prompt

Any character string (must not contain quote character)

bold_string

UPPERCASE_STRING

special characters

Must be entered as shown

other_lowercase_string_in_parameter_list

Any GDL expression

COORDINATE TRANSFORMATIONS

This chapter tells you about the types of transformations available in GDL (moving, scaling and rotating the coordinate system) and the way they are interpreted and managed.

About Transformations

In GDL, all the geometric elements are linked strictly to the local coordinate system. GDL uses a right-handed coordinate system. For example, one corner of a block is in the origin and its sides are in the x-y, x-z and y-z planes.

Placing a geometric element in the desired position requires two steps. First, move the coordinate system to the desired position. Second, generate the element. Every movement, rotation or stretching of the coordinate system along or around an axis is called a transformation. Transformations are stored in a stack; interpretation starts from the last one backwards. Scripts inherit this stack; they can insert new elements onto it but can only delete the locally defined ones. It is possible to delete one, more or all of the transformations defined in the current script. After returning from a script, the locally defined transformations are removed from the stack.

2D TRANSFORMATIONS

These are the equivalents in the 2D space of the ADD, MUL and ROTZ 3D transformations.

ADD2

ADD2 x, y

Example:

ADD2 a, b

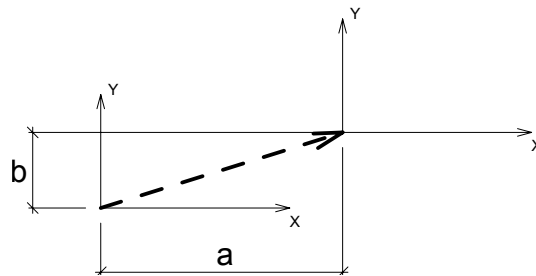

MUL2

MUL2 x, y

ROT2

ROT2 alpha

Example:

ROT2 beta

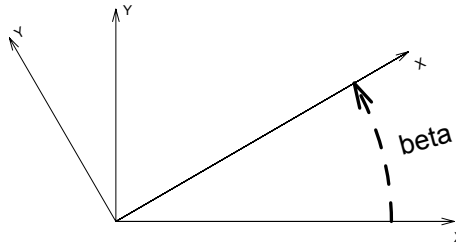

3D TRANSFORMATIONS

ADDX

ADDX dx

ADDY

ADDY dy

ADDZ

ADDZ dz

Moves the local coordinate system along the given axis by dx, dy or dz respectively.

ADD

ADD dx, dy, dz

Replaces the sequence ADDX dx: ADDY dy: ADDZ dz.

Example:

ADD a, b, c

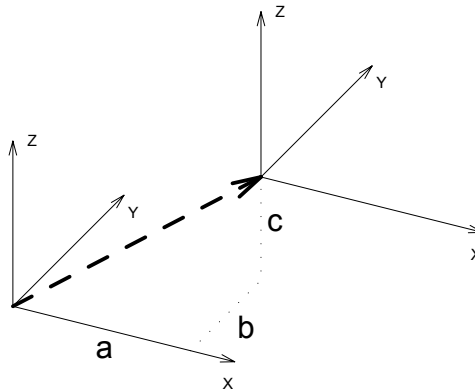

It has only one entry in the stack, thus it can be deleted with DEL 1.

MULX

MULX mx

MULY

MULY my

MULZ

MULZ mz

Scales the local coordinate system along the given axis. Negative mx, my, mz means simultaneous mirroring.

MUL

MUL mx, my, mz

Replaces the sequence MULX mx: MULY my: MULZ mz. It has only one entry in the stack, thus it can be deleted with DEL 1.

ROTX

ROTX alphax

ROTY

ROTY alphay

ROTZ

ROTZ *alpha*z

Rotates the local coordinate system around the given axis by *alpha*x, *alpha*y, *alpha*z degrees respectively, counterclockwise.

Example:

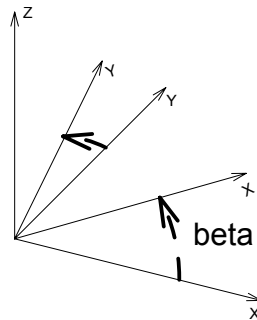

ROTZ *beta*

ROT

ROT *x, y, z, alpha*

Rotates the local coordinate system around the axis defined by the vector (*x, y, z*) by *alpha* degrees, counterclockwise. It has only one entry in the stack, thus it can be deleted with DEL 1.

XFORM

XFORM *newx_x, newy_x, newz_x, offset_x,*
newx_y, newy_y, newz_y, offset_y,
newx_z, newy_z, newz_z, offset_z

Defines a complete transformation matrix. It is mainly used in automatic GDL code generation. It has only one entry in the stack.

$$x' = \text{newx}_x * x + \text{newy}_x * y + \text{newz}_x * z + \text{offset}_x$$

$$y' = \text{newx}_y * x + \text{newy}_y * y + \text{newz}_y * z + \text{offset}_y$$

$$z' = \text{newx}_z * x + \text{newy}_z * y + \text{newz}_z * z + \text{offset}_z$$

Example:

```
A=60
B=30
XFORM 2, COS(A), COS(B)*0.6, 0,
      0, SIN(A), SIN(B)*0.6, 0,
      0, 0, 1, 0
BLOCK 1, 1, 1
```

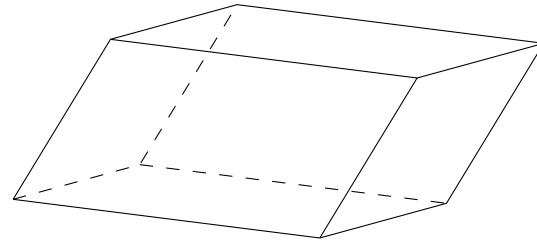

MANAGING THE TRANSFORMATION STACK

DEL

DEL *n* [, *begin_with*]

Deletes *n* entries from the transformation stack.

If the *begin_with* parameter is not specified, deletes the previous *n* entries in the transformation stack. The local coordinate system moves back to a previous position.

If the *begin_with* transformation is specified, deletes *n* entries forward, beginning with the one denoted by *begin_with*. Numbering starts with 1. If the *begin_with* parameter is specified and *n* is negative, deletes backward.

If fewer transformations were issued in the current script than denoted by the given *n* number argument, then only the issued transformations are deleted.

DEL TOP

DEL TOP

Deletes all current transformations in the current script.

NTR

NTR ()

Returns the actual number of transformations.

Example:

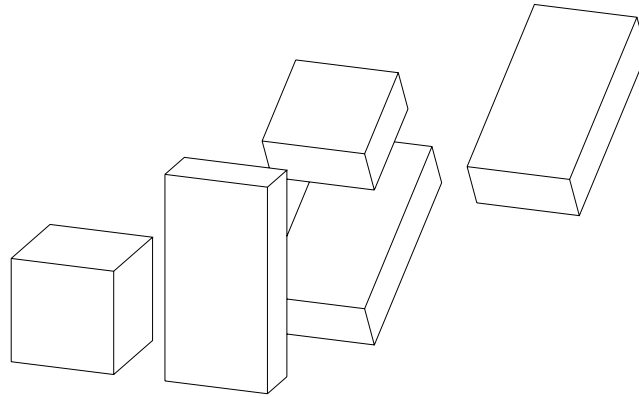

```

BLOCK 1, 1, 1
ADDX 2
ADDY 2.5
ADDZ 1.5
ROTX -60
ADDX 1.5
BLOCK 1, 0.5, 2
DEL 1, 1           ! Deletes the ADDX 2 transformation
BLOCK 1, 0.5, 1
DEL 1, NTR() - 2  ! Deletes the ADDZ 1.5 transformation
BLOCK 1, 0.5, 2
DEL -2, 3         ! Deletes the ROTX -60 and ADDY 2.5 transformations
BLOCK 1, 0.5, 2

```

3D SHAPES

This chapter covers all the 3D shape creation commands available in GDL, from the most basic ones to the generation of complex shapes from polylines. Elements for visualization (light sources, pictures) are also presented here, as well as the definition of text to be displayed in 3D. Furthermore, the primitives of the internal 3D data structure consisting of nodes, vectors, edges and bodies are discussed in detail, followed by the interpretation of binary data and guidelines for using cutting planes.

BASIC SHAPES

BLOCK

BLOCK a, b, c

BRICK

BRICK a, b, c

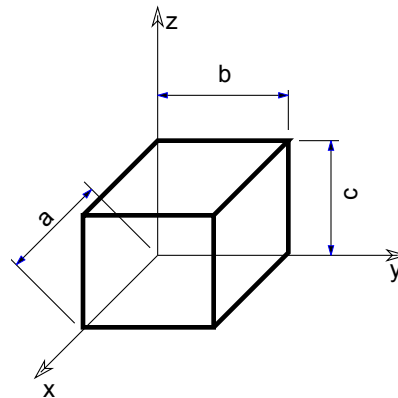

The first corner of the block is in the local origin and the edges with lengths a , b and c are along the x -, y - and z -axes, respectively. Zero values create degenerated blocks (rectangle or line).

Restriction of parameters:

$$\begin{aligned} a &\geq 0, \quad b \geq 0, \quad c \geq 0 \\ a + b + c &> 0 \end{aligned}$$

CYLIND

CYLIND h, r

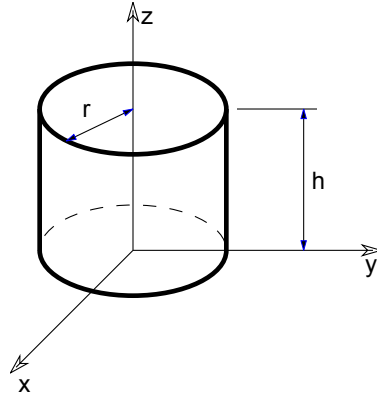

Right cylinder, coaxial with the z-axis with a height of h and a radius of r .

If $h=0$, a circle is generated in the x-y plane.

If $r=0$, a line is generated along the z axis.

SPHERE

SPHERE r

A sphere with its center at the origin and with a radius of r .

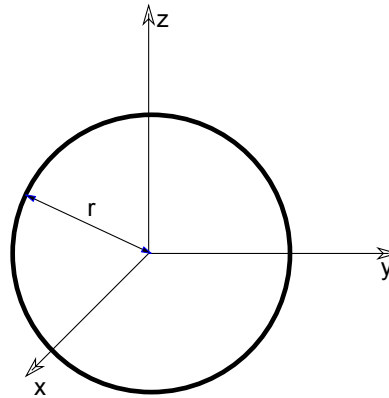

ELLIPS

ELLIPS h, r

Half ellipsoid. Its cross-section in the x-y plane is a circle with a radius of r centered at the origin. The length of the half axis along the z-axis is h.

Example: Hemisphere

ELLIPS h, r

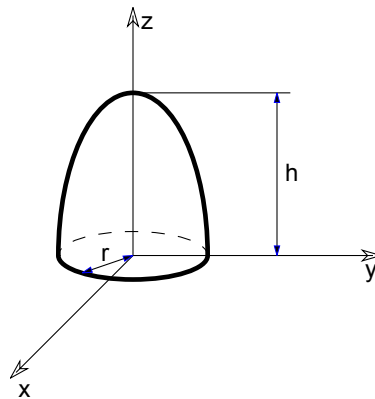

CONE

CONE h, r1, r2, alpha1, alpha2

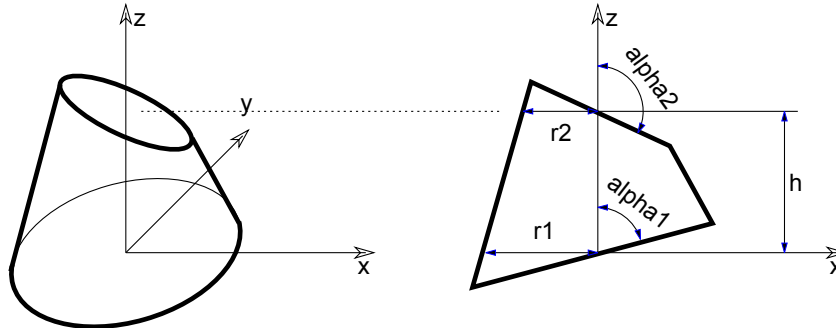

Frustum of a cone where alpha1 and alpha2 are the angles of inclination of the end surfaces to the z axis, r1 and r2 are the radii of the end-circles and h is the height along the z axis.

If h=0, the values of alpha1 and alpha2 are disregarded and an annulus is generated in the x-y plane.

alpha1 and alpha2 are in degrees.

Restriction of parameters:

$$0 < \text{alpha1} < 180^\circ \text{ and } 0 < \text{alpha2} < 180^\circ$$

Example: A regular cone

CONE h, r, 0, 90, 90

PRISM

PRISM n, h, x1, y1, ..., xn, yn

Right prism with its base polygon in the x-y plane (see the parameters of the POLY command and the POLY_ command). The height along the z-axis is abs(h). Negative h values can also be used. In that case the second base polygon is below the x-y plane.

Restriction of parameters:

$$n \geq 3$$

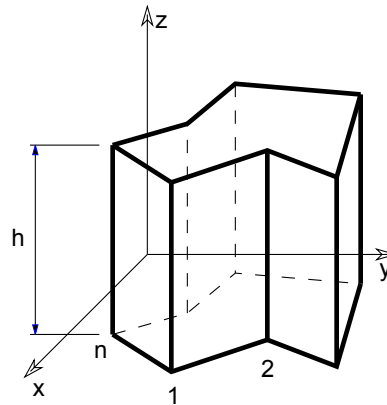

PRISM_

PRISM_ *n*, *h*, *x1*, *y1*, *s1*, ..., *xn*, *yn*, *sn*

Similar to the PRISM command, but any of the horizontal edges and sides can be omitted.

Restriction of parameters:

$$n \geq 3$$

si: status code that allows you to control the visibility of polygon edges and side surfaces. You can also define holes and create segments and arcs in the polyline using special constraints.

See Status Codes for details.

Example 1: Solid and hollow faces

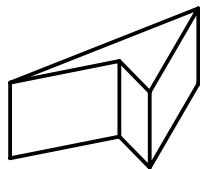

```
PRISM 4,1,  
0,0,15,  
1,1,15,  
2,0,15,  
1,3,15
```

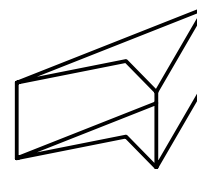

```
PRISM 4,1,  
0,0,7,  
1,1,5,  
2,0,15,  
1,3,15
```



Example 2: Holes in the polygon

```

ROTX 90
PRISM 26, 1.2,
  0.3, 0, 15,
  0.3, 0.06, 15,
  0.27, 0.06, 15,
  0.27, 0.21, 15,
  0.25, 0.23, 15,
  -0.25, 0.23, 15,
  -0.27, 0.21, 15,
  -0.27, 0.06, 15,
  -0.3, 0.06, 15,
  -0.3, 0, 15,
  0.3, 0, -1,      !End of contour
  0.10, 0.03, 15,
  0.24, 0.03, 15,
  0.24, 0.2, 15,
  0.10, 0.2, 15,
  0.10, 0.03, -1,  !End of first hole
  0.07, 0.03, 15,
  0.07, 0.2, 15,
  -0.07, 0.2, 15,
  -0.07, 0.03, 15,
  0.07, 0.03, -1,  !End of second hole
  -0.24, 0.03, 15,
  -0.24, 0.2, 15,
  -0.1, 0.2, 15,
  -0.1, 0.03, 15,
  -0.24, 0.03, -1  !End of third hole

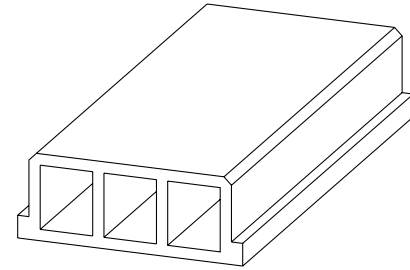
```

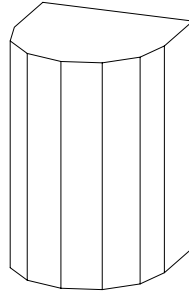

Example 3: Curved surface

j7 = 0

```

R=1
H=3
PRISM_ 9, H,
  -R,          R,          15,
  COS(180)*R, SIN(180)*R, 15,
  COS(210)*R, SIN(210)*R, 15,
  COS(240)*R, SIN(240)*R, 15,
  COS(270)*R, SIN(270)*R, 15,
  COS(300)*R, SIN(300)*R, 15,
  COS(330)*R, SIN(330)*R, 15,
  COS(360)*R, SIN(360)*R, 15,
  R,          R,          15

```

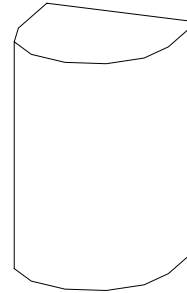

j7 = 1

```

R=1
H=3
PRISM_ 9, H,
  -R,          R,          15,
  COS(180)*R, SIN(180)*R, 64+15,
  COS(210)*R, SIN(210)*R, 64+15,
  COS(240)*R, SIN(240)*R, 64+15,
  COS(270)*R, SIN(270)*R, 64+15,
  COS(300)*R, SIN(300)*R, 64+15,
  COS(330)*R, SIN(330)*R, 64+15,
  COS(360)*R, SIN(360)*R, 64+15,
  R,          R,          15

```

CPRISM_

CPRISM_ top_material, bottom_material, side_material,
 n, h,
 x1, y1, s1, ..., xn, yn, sn

Extension of the PRISM_ command. The first three parameters are used for the material name/index of the top, bottom and side surfaces. The other parameters are the same as above in the PRISM_ command.

Restriction of parameters:

$n \geq 3$

See also the section called "Materials".

si: status code that allows you to control the visibility of polygon edges and side surfaces. You can also define holes and create segments and arcs in the polyline using special constraints.

See *Status Codes for details*.

Example: Material referencing a predefined material by name, index and global variable

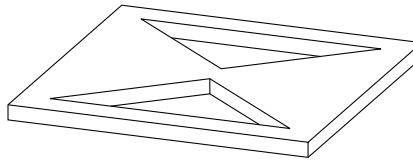

```
CPRISM_ "Mtl-Iron", 0, SYMB_MAT,
  13, 0.2,
  0, 0, 15,
  2, 0, 15,
  2, 2, 15,
  0, 2, 15,
  0, 0, -1,           !end of the contour
  0.2, 0.2, 15,
  1.8, 0.2, 15,
  1.0, 0.9, 15,
  0.2, 0.2, -1,       !end of first hole
  0.2, 1.8, 15,
  1.8, 1.8, 15,
  1.0, 1.1, 15,
  0.2, 1.8, -1        !end of second hole
```

CPRISM_{2}

```
CPRISM_{2} top_material, bottom_material, side_material,
  n, h,
  x1, y1, alpha1, s1, mat1,
  ...
  xn, yn, alphan, sn, matn
```

CPRISM_{2} is an extension of the CPRISM_ command with the possibility of defining different angles and materials for each side of the prism. The side angle definition is similar to the one of the CROOF_ command.

alpha_i: the angle between the face belonging to the edge *i* of the prism and the plane perpendicular to the base.

mat_i: material reference that allows you to control the material of the side surfaces.

CPRISM_{3}

```
CPRISM_{3} top_material, bottom_material, side_material, mask,
           n, h,
           x1, y1, alpha1, s1, mat1,
           ...
           xn, yn, alphan, sn, matn
```

CPRISM_{3} is an extension of the CPRISM_{2} command with the possibility of controlling the global behavior of the generated prism.

mask: controls the global behavior of the generated prism.

mask = $j_1 + 2*j_2 + 4*j_3 + 8*j_4$, where each *j* can be 0 or 1.

*j*₁: top edge in line elimination.

*j*₂: bottom edge in line elimination.

*j*₃: side edge in line elimination.

*j*₄: side edge and surface is smooth in curved sections of the profile. *Compatibility: introduced in ARCHICAD 21.*

Example 1:

```
PEN 1
mat = IND (MATERIAL, "Metal-Aluminium")
FOR i=1 TO 4 STEP 1
  IF i = 1 THEN mask = 1+2+4
  IF i = 2 THEN mask = 1
  IF i = 3 THEN mask = 2
  IF i = 4 THEN mask = 4
  CPRISM_{3} mat, mat, mat, mask,
    5, 1,
    0, 0, 0, 15, mat,
    1, 0, 0, 15, mat,
    1, 1, 0, 15, mat,
    0, 1, 0, 15, mat,
    0, 0, 0, -1, mat
  BODY -1
  DEL TOP
  IF i = 1 THEN ADDY 1
  IF i = 2 THEN ADDX -1
  IF i = 3 THEN ADDX 1
NEXT i
```

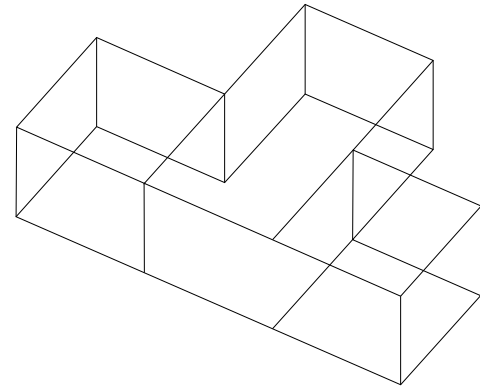

Example 2:

```

PEN 1
mat = IND (MATERIAL, "Metal-Aluminium")
!visible side segment edges
mask = 1 + 2 + 4
_secondStat = 15
_CPRISM_{3} mat, mat, mat, mask,
  6, 1,
  0, 0, 0, 15, mat,
  1, 0, 0, _secondStat, mat,
  0.5, 0.5, 0, 900, mat,
  1, 1, 0, 3015, mat,
  0, 1, 0, 15, mat,
  0, 0, 0, -1, mat

!smooth edges using first node status copy
mask = 1 + 2 + 4
_secondStat = 15 + 64
_CPRISM_{3} mat, mat, mat, mask,
  6, 1,
  0, 0, 0, 15, mat,
  1, 0, 0, _secondStat, mat,
  0.5, 0.5, 0, 900, mat,
  1, 1, 0, 3015, mat,
  0, 1, 0, 15, mat,
  0, 0, 0, -1, mat

!smooth edges using mask, first edge is not smooth
mask = 1 + 2 + 4 + 8
_secondStat = 15
_CPRISM_{3} mat, mat, mat, mask,
  6, 1,
  0, 0, 0, 15, mat,
  1, 0, 0, _secondStat, mat,
  0.5, 0.5, 0, 900, mat,
  1, 1, 0, 3015, mat,
  0, 1, 0, 15, mat,
  0, 0, 0, -1, mat

```

CPRISM_{4}

```
CPRISM_{4} top_material, bottom_material, side_material, mask,
           n, h,
           x1, y1, alpha1, s1, mat1,
           ...
           xn, yn, alphan, sn, matn
```

CPRISM_{4} is an extension of the CPRISM_{3} command with the possibility of using inline material definition, that means materials defined in GDL script locally also can be used next to materials defined in global material definitions.

BPRISM_

```
BPRISM_ top_material, bottom_material, side_material,
         n, h, radius,
         x1, y1, s1,
         ...
         xn, yn, sn
```

A smooth curved prism, based on the same data structure as the straight CPRISM_ element. The only additional parameter is radius.

Derived from the corresponding CPRISM_ by bending the x-y plane onto a cylinder tangential to that plane. Edges along the x axis are transformed to circular arcs; edges along the y axis remain horizontal; edges along the z axis will be radial in direction.

See the BWALL_ command for details.

si: status code that allows you to control the visibility of polygon edges and side surfaces. You can also define holes and create segments and arcs in the polyline using special constraints.

See Status Codes for details.

Example: Curved prisms with the corresponding straight ones

```
BPRISM_ "Glass - Blue",
        "Glass - Blue",
        "Glass - Blue",
        3, 0.4, 1,           ! radius = 1
        0, 0, 15,
        5, 0, 15,
        1.3, 2, 15
```

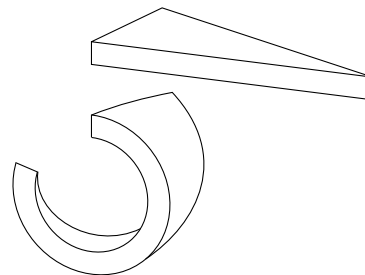

```

BPRISM_ "Concrete", "Concrete", "Concrete",
17, 0.3, 5,
0, 7.35, 15,
0, 2, 15,
1.95, 0, 15,
8, 0, 15,
6.3, 2, 15,
2, 2, 15,
4.25, 4, 15,
8, 4, 15,
8, 10, 15,
2.7, 10, 15,
0, 7.35, -1,
4, 8.5, 15,
1.85, 7.05, 15,
3.95, 5.6, 15,
6.95, 5.6, 15,
6.95, 8.5, 15,
4, 8.5, -1

```

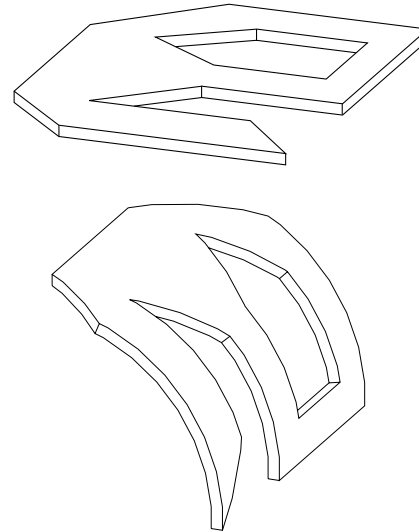

FPRISM_

```

FPRISM_ top_material, bottom_material, side_material, hill_material,
n, thickness, angle, hill_height,
x1, y1, s1,
...
xn, yn, sn

```

Similar to the PRISM_ command, with the additional hill_material, angle and hill_height parameters for forming a ramp on the top.

hill_material: the side material of the ramp part.

angle: the inclination angle of the ramp side edges.

Restriction: $0 \leq \text{angle} < 90$.

If angle = 0, the hill side edges seen from an orthogonal view form a quarter circle with the current resolution (see the RADIUS command, the RESOL command and the TOLER command).

hill_height: the height of the ramp. Note that the thickness parameter represents the whole height of the prism.

si: status code that allows you to control the visibility of polygon edges and side surfaces. You can also define holes and create segments and arcs in the polyline using special constraints.

Restriction of parameters:

$n \geq 3$, $\text{hill_height} < \text{thickness}$

See Status Codes for details.

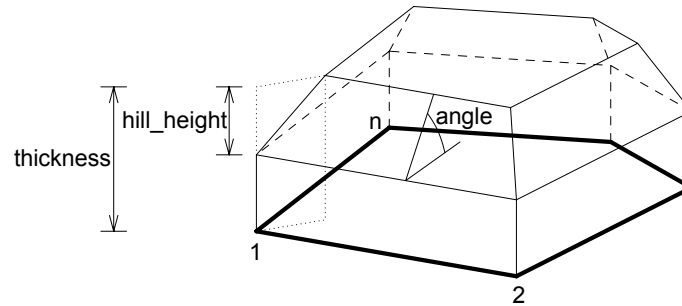

Example 1: Prism with curved ramp

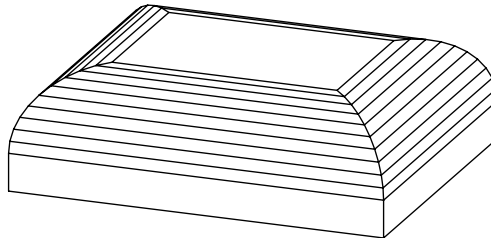

```
RESOL 10
FPRISM_ "Roof Tile", "Brick-Red", "Brick-White", "Roof Tile",
  4, 1.5, 0, 1.0,      !angle = 0
  0, 0, 15,
  5, 0, 15,
  5, 4, 15,
  0, 4, 15
```

Example 2: Prism with straight ramp

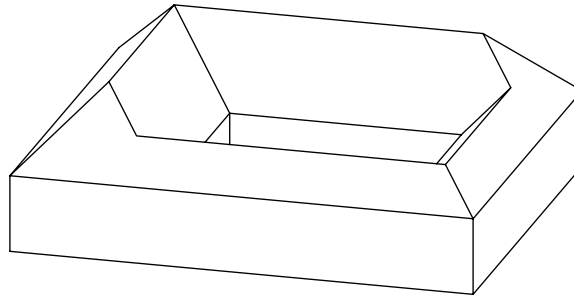

```
FPRISM_ "Roof Tile", "Brick-Red", "Brick-White",
        "Roof Tile",
        10, 2, 45, 1,
        0, 0, 15,
        6, 0, 15,
        6, 5, 15,
        0, 5, 15,
        0, 0, -1,
        1, 2, 15,
        4, 2, 15,
        4, 4, 15,
        1, 4, 15,
        1, 2, -1
```

HPRISM_

```
HPRISM_ top_mat, bottom_mat, side_mat,
        hill_mat,
        n, thickness, angle, hill_height, status,
        x1, y1, s1,
        ...
        xn, yn, sn
```

Similar to FPRISM_, with an additional parameter controlling the visibility of the hill edges.

status: controls the visibility of the hill edges:

0: hill edges are all visible (FPRISM_)

1: hill edges are invisible

SPRISM_

```

SPRISM_ top_material, bottom_material, side_material,
          n, xb, yb, xe, ye, h, angle,
          x1, y1, s1,
          ...
          xn, yn, sn
  
```

Extension of the CPRISM_ command, with the possibility of setting the upper polygon non-parallel with the x-y plane. The upper plane definition is similar to the plane definition of the CROOF_ command. The height of the prism is defined at the reference line. Upper and lower polygon intersection is forbidden.

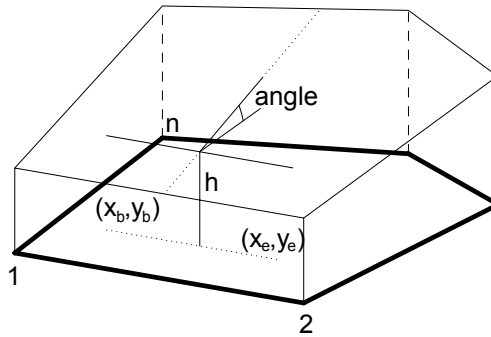

xb, yb, xe, ye: reference line (vector) starting and end coordinates.

angle: rotation angle of the upper polygon around the given oriented reference line in degrees (CCW).

si: status code that allows you to control the visibility of polygon edges and side surfaces. You can also define holes and create segments and arcs in the polyline using special constraints.

See Status Codes for details.

Note: All calculated z coordinates of the upper polygon nodes must be positive or 0.

Example:

```
SPRISM_ 'Grass', 'Earth', 'Earth',
  6,
  0, 0, 11, 6, 2, -10.0,
  0, 0, 15,
  10, 1, 15,
  11, 6, 15,
  5, 7, 15,
  4.5, 5.5, 15,
  1, 6, 15
```

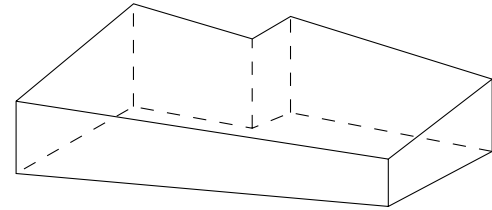

SPRISM_{2}

```
SPRISM_{2} top_material, bottom_material, side_material,
  n,
  xtb, ytb, xte, yte, topz, tangle,
  xbb, ybb, xbe, ybe, bottomz, bangle,
  x1, y1, s1, mat1,
  ...
  xn, yn, sn, matn
```

Extension of the SPRISM_ command, with the possibility of having an upper and lower polygon non-parallel with the x-y plane. The definition of the planes is similar to the plane definition of the CROOF_ command. The top and bottom of the prism is defined at the reference line. Upper and lower polygon intersection is forbidden.

x_{tb}, y_{tb}, x_{te}, y_{te}: reference line (vector) of the top polygon starting and end coordinates.

topz: the 'z' level of the reference line of the top polygon.

tangle: rotation angle of the top polygon around the given oriented reference line in degrees (CCW).

x_{bb}, y_{bb}, x_{be}, y_{be}: reference line (vector) of the bottom polygon starting and end coordinates.

bottomz: the 'z' level of the reference line of the bottom polygon.

bangle: rotation angle of the bottom polygon around the given oriented reference line in degrees (CCW).

si: status code that allows you to control the visibility of polygon edges and side surfaces. You can also define holes and create segments and arcs in the polyline using special constraints.

See Status Codes for details.

mati: material reference that allows you to control the material of the side surfaces.

Example:

```
SPRISM_{2} 'Grass', 'Earth', 'Earth',
  11,
  0, 0, 11, 0, 30, -30.0,
  0, 0, 0, 11, 2, 30.0,
  0, 0, 15, IND (MATERIAL, 'C10'),
  10, 1, 15, IND (MATERIAL, 'C11'),
  11, 6, 15, IND (MATERIAL, 'C12'),
  5, 7, 15, IND (MATERIAL, 'C13'),
  4, 5, 15, IND (MATERIAL, 'C14'),
  1, 6, 15, IND (MATERIAL, 'C10'),
  0, 0, -1, IND (MATERIAL, 'C15'),
  9, 2, 15, IND (MATERIAL, 'C15'),
  10, 5, 15, IND (MATERIAL, 'C15'),
  6, 4, 15, IND (MATERIAL, 'C15'),
  9, 2, -1, IND (MATERIAL, 'C15')
```

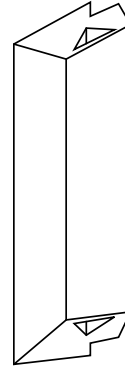

SPRISM_{3}

```
SPRISM_{3} top_material, bottom_material, side_material, mask,
  n,
  xtb, ytb, xte, yte, topz, tangle,
  xbb, ybb, xbe, ybe, bottomz, bangle,
  x1, y1, s1, mat1,
  ...
  xn, yn, sn, matn
```

Extension of the SPRISM_{2} command with the possibility of controlling the global behavior of the generated prism.

mask: controls the global behavior of the generated prism.

$\text{mask} = j_1 + 2*j_2 + 4*j_3 + 8*j_4$, where each j can be 0 or 1.

j_1 : top edge in line elimination.

j_2 : bottom edge in line elimination.

j_3 : side edge in line elimination.

j₄: side edge and surface is smooth in curved sections of the profile. *Compatibility: introduced in ARCHICAD 21.*

Example:

```

PEN 1
mat = IND (MATERIAL, "Metal-Aluminium")
FOR i=1 TO 4 STEP 1
  IF i = 1 THEN mask = 1+2+4
  IF i = 2 THEN mask = 1
  IF i = 3 THEN mask = 2
  IF i = 4 THEN mask = 4
  SPRISM_{3} mat, mat, mat, mask,
    5,
    0, 0, 1, 0, 1, 0,
    0, 0, 1, 0, 0, 0,
    0, 0, 15, mat,
    1, 0, 15, mat,
    1, 1, 15, mat,
    0, 1, 15, mat,
    0, 0, -1, mat

  BODY -1
  DEL TOP
  IF i = 1 THEN ADDY 1
  IF i = 2 THEN ADDX -1
  IF i = 3 THEN ADDX 1
NEXT i

```

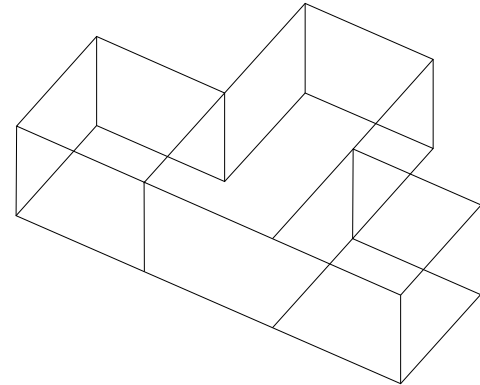

SPRISM_{4}

```

SPRISM_{4} top_material, bottom_material, side_material, mask,
  n,
  xtb, ytb, xte, yte, topz, tangle,
  xbb, ybb, xbe, ybe, bottomz, bangle,
  x1, y1, s1, mat1,
  ...
  xn, yn, sn, matn

```

SPRISM_{4} is an extension of the SPRISM_{3} command with the possibility of using inline material definition, that means materials defined in GDL script locally also can be used next to materials defined in global material definitions.

SLAB

SLAB *n*, *h*, *x1*, *y1*, *z1*, ..., *xn*, *yn*, *zn*

Oblique prism. The lateral faces are always perpendicular to the x-y plane. Its bases are flat polygons rotated about an axis parallel with the x-y plane. Negative *h* values can also be used. In that case the second base polygon is below the given one.

No check is made as to whether the points are really on a plane. Apices not lying on a plane will result in strange shadings/ renderings.

Restriction of parameters:

$$n \geq 3$$

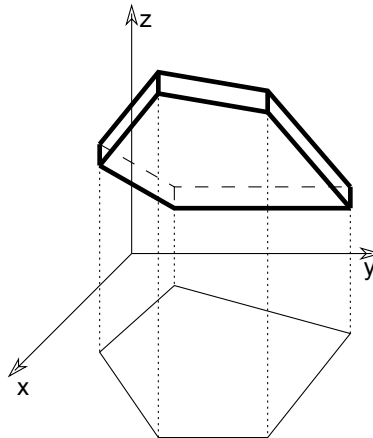

SLAB_

SLAB_ *n*, *h*, *x1*, *y1*, *z1*, *s1*, ..., *xn*, *yn*, *zn*, *sn*

Similar to the SLAB command, but any of the edges and faces of the side polygons can be omitted. This statement is an analogy of the PRISM_ command.

si: status code that allows you to control the visibility of polygon edges and side surfaces. You can also define holes and create segments and arcs in the polyline using special constraints.

See Status Codes for details.

CSLAB_

```
CSLAB_ top_material, bottom_material, side_material,
       n, h,
       x1, y1, z1, s1, ..., xn, yn, zn, sn
```

Extension of the SLAB_ command; the first three parameters are used for the material name/index of the top, bottom and side surfaces. The other parameters are the same as above in the SLAB_ command.

si: status code that allows you to control the visibility of polygon edges and side surfaces. You can also define holes and create segments and arcs in the polyline using special constraints.

See Status Codes for details.

CWALL_

```
CWALL_ left_material, right_material, side_material,
       height, x1, x2, x3, x4, t,
       mask1, mask2, mask3, mask4,
       n,
       x_start1, y_low1, x_end1, y_high1, frame_shown1,
       ...
       x_startn, y_lown, x_endn, y_highn, frame_shownn,
       m,
       a1, b1, c1, d1,
       ...
       am, bm, cm, dm
```

left_material, right_material, side_material: Material names/indices for the left, right and side surfaces. (The left and right sides of the wall follow the x axis.)

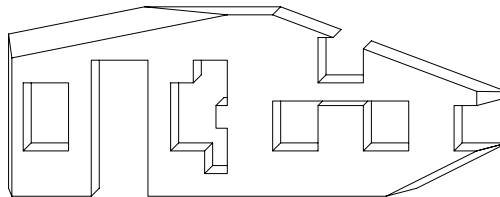

The reference line of the wall is always transformed to coincide with the x axis. The sides of the wall are in the x-z plane.

height: The height of the wall relative to its base.

x1, x2, x3, x4: The projected endpoints of the wall lying on the x-y plane as seen below. If the wall stands on its own, then $x1 = x4 = 0$, $x2 = x3 =$ the length of the wall.

t: the thickness of the wall.

$t < 0$: if the body of the wall is to the right of the x axis,

$t > 0$: if the body of the wall is to the left of the x axis,

$t = 0$: if the wall is represented by a polygon and frames are generated around the holes.

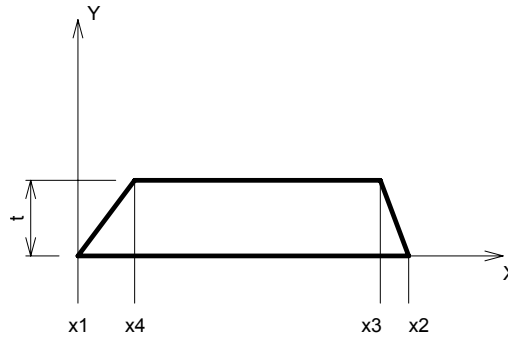

mask1, mask2, mask3, mask4: Control the visibility of edges and side polygons.

$mask1, mask2, mask3, mask4 = j_1 + 2*j_2 + 4*j_3 + 8*j_4$, where each j can be 0 or 1.

The j_1, j_2, j_3 bits represent whether the edges of the side polygon are present (1) or omitted (0). The j_4 bit represents whether edges on the side polygon arisen from cut are present (1) or omitted (0).

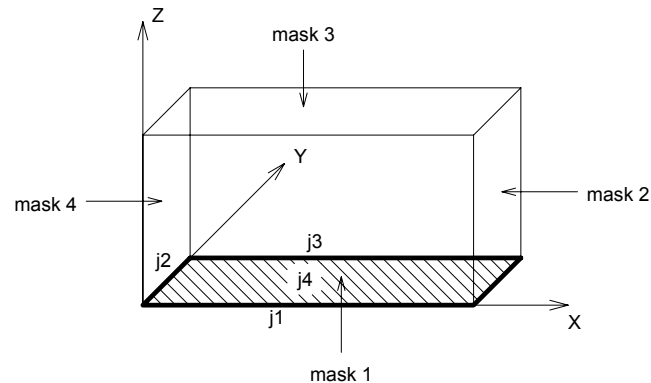

n: the number of openings in the wall.

x_start_i, y_low_i, x_end_i, y_high_i: coordinates of the openings as shown below.

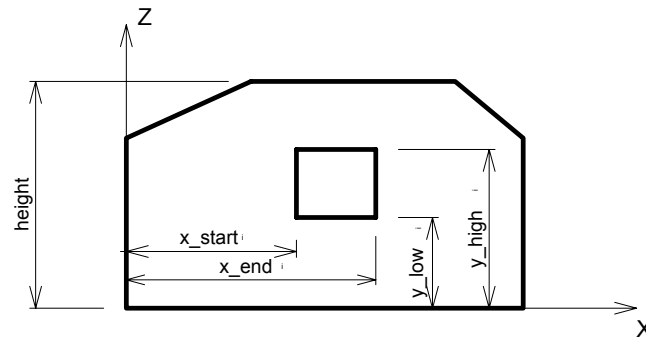

frame_show_{n_i}:

1: if the edges of the hole are visible,

0: if the edges of the hole are invisible,

< 0: control the visibility of each of the opening's edges separately: $\text{frame_show}_{n_i} = -(1*j_1 + 2*j_2 + 4*j_3 + 8*j_4 + 16*j_5 + 32*j_6 + 64*j_7 + 128*j_8)$, where j_1, j_2, \dots, j_8 can be either 0 or 1. The numbers j_1 to j_4 control the visibility of the edges of the hole on the left-hand side of the wall surface, while j_5 to j_8 affect the edges on the right-hand side, as shown on the illustration below.

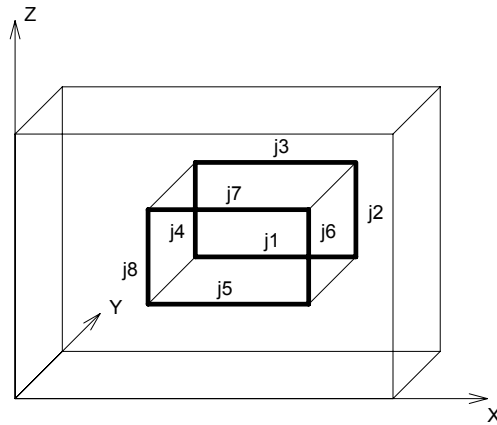

An edge that is perpendicular to the surface of the wall is visible if there are visible edges drawn from both of its endpoints.

m: the number of cutting planes.

ai, bi, ci, di: coefficients of the equation defining the cutting plane [$a_i \cdot x + b_i \cdot y + c_i \cdot z = d_i$]. Parts on the positive side of the cutting plane (i.e., $a_i \cdot x + b_i \cdot y + c_i \cdot z > d_i$) will be cut and removed

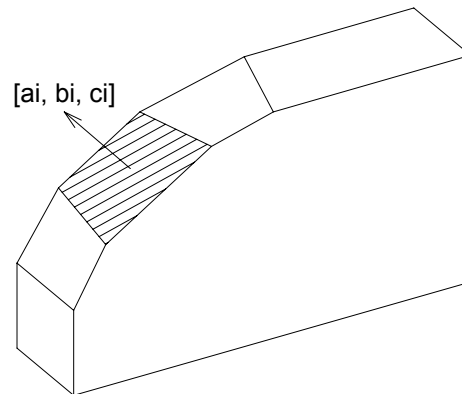

BWALL_

```

BWALL_ left_material, right_material, side_material,
         height, x1, x2, x3, x4, t, radius,
         mask1, mask2, mask3, mask4,
         n,
         x_start1, y_low1, x_end1, y_high1, frame_shown1,
         ...
         x_startn, y_lown, x_endn, y_highn, frame_shownn,
         m,
         a1, b1, c1, d1,
         ...
         am, bm, cm, dm

```

A smooth curved wall based on the same data structure as the straight wall `CWALL_` element. The only additional parameter is radius. Derived from the corresponding `CWALL_` by bending the x-z plane onto a cylinder tangential to that plane. Edges along the x axis are transformed to circular arcs, edges along the y axis will be radial in direction, and vertical edges remain vertical. The curvature is approximated by a number of segments set by the current resolution (see the `RADIUS` command, the `RESOL` command and the `TOLER` command).

See also the `CWALL_` command for details.

Example 1: a `BWALL_` and the corresponding `CWALL_`

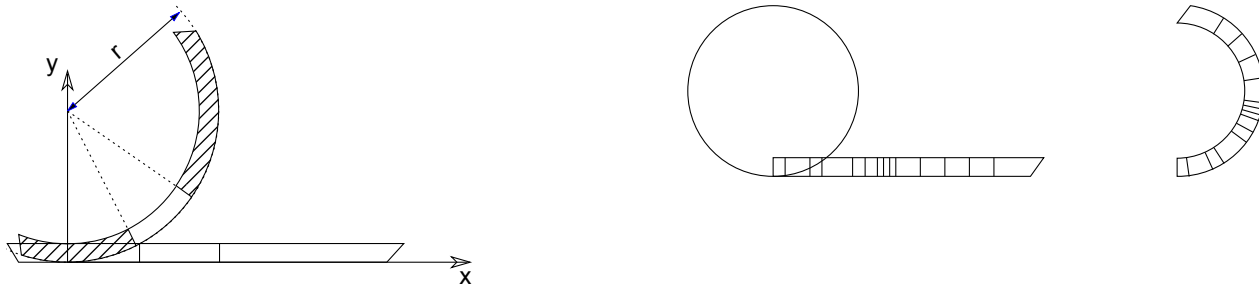

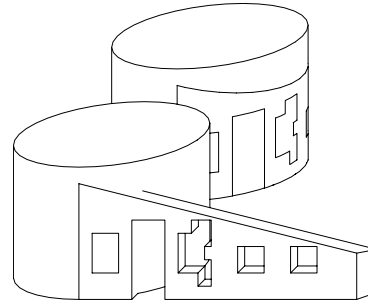
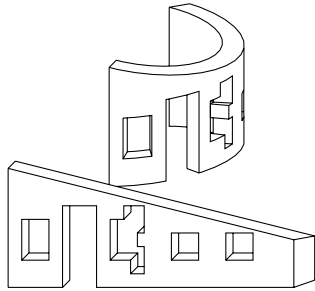

Example 2:

```

ROTZ -60
BWALL_ 1, 1, 1,
        4, 0, 6, 6, 0,
        0.3, 2,
        15, 15, 15, 15,
        5,
        1, 1, 3.8, 2.5, -255,
        1.8, 0, 3, 2.5, -255,
        4.1, 1, 4.5, 1.4, -255,
        4.1, 1.55, 4.5, 1.95, -255,
        4.1, 2.1, 4.5, 2.5, -255,
        1, 0, -0.25, 1, 3

```

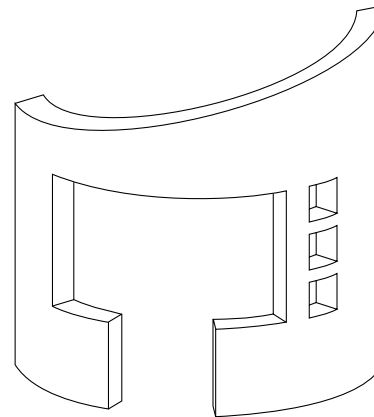

XWALL_

```

XWALL_ left_material, right_material, vertical_material, horizontal_material,
        height, x1, x2, x3, x4,
        y1, y2, y3, y4,
        t, radius,
        log_height, log_offset,
        mask1, mask2, mask3, mask4,
        n,
        x_start1, y_low1, x_end1, y_high1,
        frame_shown1,
        ...
        x_startn, y_lown, x_endn, y_highn,
        frame_shownn,
        m,
        a1, b1, c1, d1,
        ...
        am, bm, cm, dm,
        status

```

Extended wall definition based on the same data structure as the BWALL_ element.

vertical_material, horizontal_material: name or index of the vertical/horizontal side materials.

y1, y2, y3, y4: the projected endpoints of the wall lying in the x-y plane as seen below.

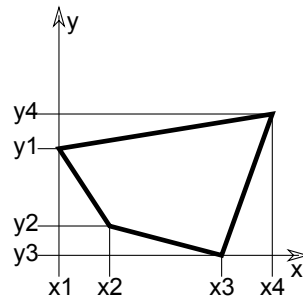

log_height, log_offset: additional parameters allowing you to compose a wall from logs. Effective only for straight walls.

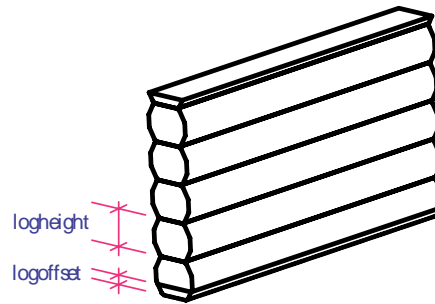

status: controls the behavior of log walls

$\text{status} = j_1 + 2*j_2 + 4*j_3 + 32*j_6 + 64*j_7 + 128*j_8 + 256*j_9$, where each j can be 0 or 1.

j_1 : apply right side material on horizontal edges,

j_2 : apply left side material on horizontal edges,

j_3 : start with half log,

j_6 : align texture to wall edges,

j_7 : double radius on bended side,

j_8 : square log on the right side,

j_9 : square log on the left side.

Example:

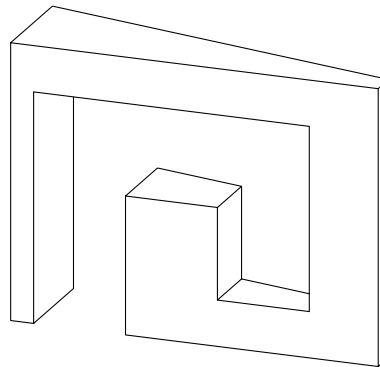

```
XWALL_ "Surf-White", "Surf-White", "Surf-White", "Surf-White",
  3.0,
  0.0, 4.0, 4.0, 0.0,
  0.0, 0.0, 0.3, 1.2,
  1.2, 0.0,
  0.0, 0.0,
  15, 15, 15, 15,
  3,
  0.25, 0.0, 1.25, 2.5, -255,
  1.25, 1.5, 2.25, 2.5, -255,
  2.25, 0.5, 3.25, 2.5, -255, 0
```

XWALL_{2}

```
XWALL_{2} left_material, right_material, vertical_material, horizontal_material,
  height, x1, x2, x3, x4,
  y1, y2, y3, y4,
  t, radius,
  log_height, log_offset,
  mask1, mask2, mask3, mask4,
  n,
  x_start1, y_low1, x_end1, y_high1,
  sill_depth1, frame_show1,
  ...
  x_startn, y_lown, x_endn, y_highn,
  sill_depthn, frame_shown,
  m,
  a1, b1, c1, d1,
  ...
  am, bm, cm, dm,
  status
```

Extended wall definition based on the same data structure as the XWALL_ element.

silldepthi: logical depth of the opening sill. If the j9 bit of the frame_showni parameter is set, the wall side materials wraps the hole polygons, silldepthi defining the separator line between them.

frame_showni:

- 1: if the edges of the hole are visible,
- 0: if the edges of the hole are invisible,

< 0: control the visibility of each of the opening's edges separately: $\text{frame_shown}_i = -(1*j_1 + 2*j_2 + 4*j_3 + 8*j_4 + 16*j_5 + 32*j_6 + 64*j_7 + 128*j_8 + 256*j_9 + 512*j_{10})$, where j_1, j_2, \dots, j_{10} can be either 0 or 1. There are two additional values to control the material wrapping. The meaning of the j_1, j_2, \dots, j_8 values are the same as at the CWALL_ and XWALL_ commands. The j_9 value controls the material of the hole polygons. If j_9 is 1, the hole inherits the side materials of the wall. The j_{10} value controls the form of the separator line between the hole materials on the upper and lower polygons of the hole in case of a bent wall. If the j_{10} value is 1, the separator line will be straight, otherwise curved.

XWALL_{3}

```
XWALL_{3} left_material, right_material, vertical_material, horizontal_material,
height, x1, x2, x3, x4,
y1, y2, y3, y4,
t, radius,
log_height, log_offset,
mask1, mask2, mask3, mask4,
n,
x_start1, y_low1, x_end1, y_high1,
sill_depth1, frame_shown1,
...
x_startn, y_lown, x_endn, y_highn,
sill_depthn, frame_shownn,
m,
a1, b1, c1, d1,
...
am, bm, cm, dm,
status
```

XWALL_{3} is an extension of XWALL_{2} command with the possibility of hiding all edges of the log wall.

status: controls the behavior of log walls

$\text{status} = j_1 + 2*j_2 + 4*j_3 + 32*j_6 + 64*j_7 + 128*j_8 + 256*j_9 + 512*j_{10}$, where each j can be 0 or 1.

j_1 : apply right side material on horizontal edges,

j_2 : apply left side material on horizontal edges,

j_3 : start with half log,

j_6 : align texture to wall edges,

j_7 : double radius on bended side,

j_8 : square log on the right side,

j_9 : square log on the left side,

j_{10} : hide all edges of log wall.

Example:

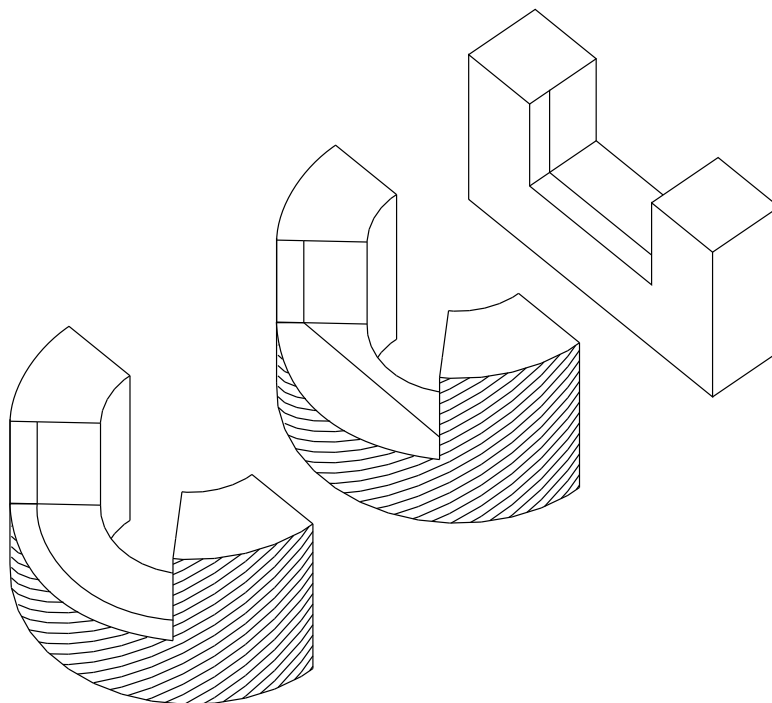

```
ROTZ 90
xWALL_{2} "C13", "C11", "C12", "C12",
  2, 0, 4, 4, 0,
  0, 0, 1, 1,
  1, 0,
  0, 0,
  15, 15, 15, 15,
  1,
  1, 0.9, 3, 2.1, 0.3, -(255 + 256),
  0,
  0

DEL 1
ADDX 2
xWALL_{2} "C13", "C11", "C12", "C12",
  2, 0, 2 * PI, 2 * PI, 0,
  0, 0, 1, 1,
  1, 2,
  0, 0,
  15, 15, 15, 15,
  1,
  1.6, 0.9, 4.6, 2.1, 0.3, -(255 + 256),
  0,
  0

ADDX 4
xWALL_{2} "C13", "C11", "C12", "C12",
  2, 0, 2 * PI, 2 * PI, 0,
  0, 0, 1, 1,
  1, 2,
  0, 0,
  15, 15, 15, 15,
  1,
  1.6, 0.9, 4.6, 2.1, 0.3, -(255 + 256 + 512),
  0,
  0
```

BEAM

```
BEAM left_material, right_material, vertical_material,
      top_material, bottom_material,
      height,
      x1, x2, x3, x4,
      y1, y2, y3, y4, t,
      mask1, mask2, mask3, mask4
```

Beam definition. Parameters are similar to those of the XWALL_ element.

top_material, bottom_material: top and bottom materials.

Example:

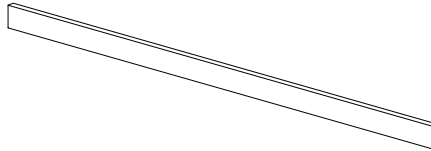

```
BEAM 1, 1, 1, 1, 1,
      0.3,
      0.0, 7.0, 7.0, 0.0,
      0.0, 0.0, 0.1, 0.1, 0.5,
      15, 15, 15, 15
```

CROOF_

```
CROOF_ top_material, bottom_material, side_material,
        n, xb, yb, xe, ye, height, angle, thickness,
        x1, y1, alpha1, s1,
        ...
        xn, yn, alphan, sn
```

A sloped roof pitch with custom angle ridges.

top_material, bottom_material, side_material: name/index of the top, bottom and side material.

n: the number of nodes in the roof polygon.

xb, yb, xe, ye: reference line (vector).

height: the height of the roof at the reference line (lower surface).

angle: the rotation angle of the roof plane around the given oriented reference line in degrees (CCW).

thickness: the thickness of the roof measured perpendicularly to the plane of the roof.

xi, yi: the coordinates of the nodes of the roof's lower polygon.

alpha_i: the angle between the face belonging to the edge *i* of the roof and the plane perpendicular to the roof plane, $-90^\circ < \alpha_i < 90^\circ$. Looking in the direction of the edge of the properly oriented roof polygon, the CCW rotation angle is positive. The edges of the roof polygon are oriented properly if, in top view, the contour is sequenced CCW and the holes are sequenced CW.

si: status code that allows you to control the visibility of polygon edges and side surfaces. You can also define holes and create segments and arcs in the polyline using special constraints.

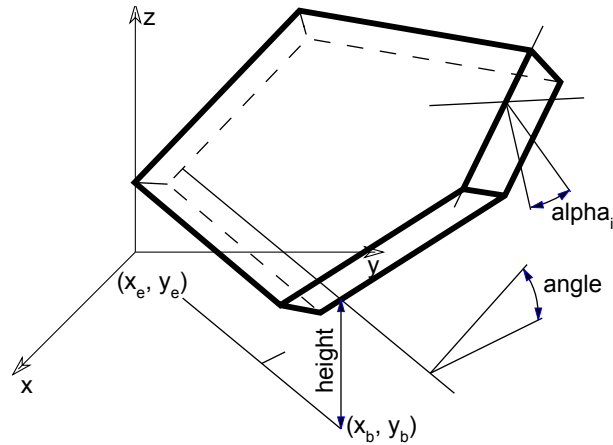

See Status Codes for details.

Restriction of parameters:

$$n \geq 3$$

Example 1:

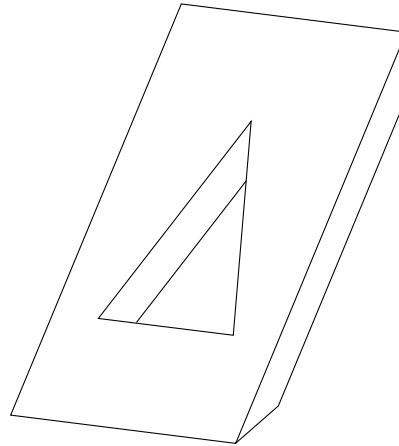

```

CROOF_ 1, 1, 1, ! materials
9,
0, 0,
1, 0, ! reference line (xb,yb) (xe,ye)
0.0, ! height
-30, ! angle
2.5, ! thickness
0, 0, -60, 15,
10, 0, 0, 15,
10, 20, -30, 15,
0, 20, 0, 15,
0, 0, 0, -1,
2, 5, 0, 15,
8, 5, 0, 15,
5, 15, 0, 15,
2, 5, 0, -1

```

Example 2:

```

L=0.25
r=(0.6^2+L^2)/(2*L)
a=ASN(0.6/r)
CROOF_ "Roof Tile", "Pine", "Pine",
  16, 2, 0, 0,
  0, 0, 45, -0.2*SQR(2),
  0, 0, 0, 15,
  3.5, 0, 0, 15,
  3.5, 3, -45, 15,
  0, 3, 0, 15,
  0, 0, 0, -1,
  0.65, 1, -45, 15,
  1.85, 1, 0, 15,
  1.85, 2.4-L, 0, 13,
  1.25, 2.4-r, 0, 900,
  0, 2*a, 0, 4015,
  0.65, 1, 0, -1,
  2.5, 2, 45, 15,
  3, 2, 0, 15,
  3, 2.5, -45, 15,
  2.5, 2.5, 0, 15,
  2.5, 2, 0, -1

```

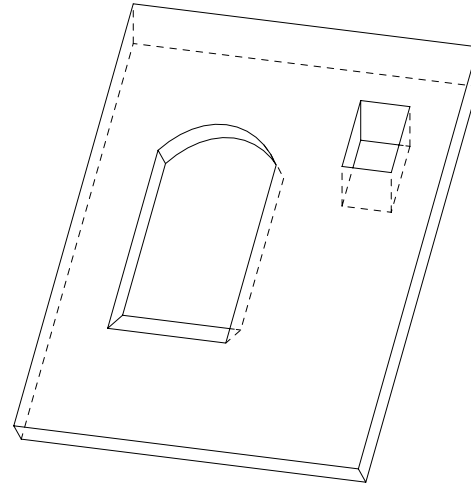

CROOF_{2}

```

CROOF_{2} top_material, bottom_material, side_material,
  n, xb, yb, xe, ye, height, angle, thickness,
  x1, y1, alpha1, s1, mat1,
  ...
  xn, yn, alphan, sn, matn

```

Extension of the CROOF_ command with the possibility of defining different materials for the sides.

mati: material reference that allows you to control the material of the side surfaces.

CROOF_{3}

CROOF_{3} top_material, bottom_material, side_material, mask,
 n, xb, yb, xe, ye, height, angle, thickness,
 x1, y1, alpha1, s1, mat1,
 ...
 xn, yn, alphan, sn, matn

Extension of the CROOF_{2} command with the possibility of controlling the global behavior of the generated roof.

mask: controls the global behavior of the generated roof.

mask = $j_1 + 2*j_2 + 4*j_3 + 8*j_4$, where each j can be 0 or 1.

j_1 : top edge in line elimination.

j_2 : bottom edge in line elimination.

j_3 : side edge in line elimination.

j_4 : side edge and surface is smooth in curved sections of the profile. *Compatibility: introduced in ARCHICAD 21.*

Example:

```

PEN 1
mat = IND (MATERIAL, "Metal-Aluminium")
FOR i=1 TO 4 STEP 1
  IF i = 1 THEN mask = 1+2+4
  IF i = 2 THEN mask = 1
  IF i = 3 THEN mask = 2
  IF i = 4 THEN mask = 4
  CROOF_{3} mat, mat, mat, mask,
    5, 0, 1, 2, 1, 3, -45, 0.3,
    0, 0, 0, 15, mat,
    1, 0, 0, 15, mat,
    1, 1, 0, 15, mat,
    0, 1, 0, 15, mat,
    0, 0, 0, -1, mat
  BODY -1
  DEL TOP
  IF i = 1 THEN ADD 0,1,1
  IF i = 2 THEN ADDX -1
  IF i = 3 THEN ADDX 1
NEXT i

```

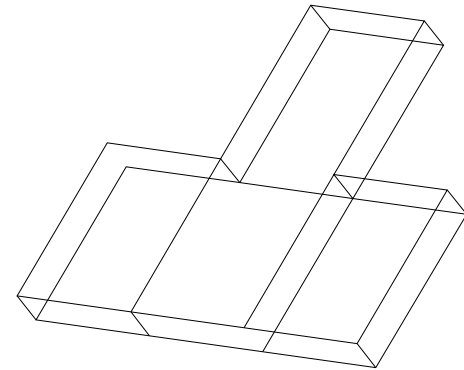

CROOF_{4}

CROOF_{4} top_material, bottom_material, side_material, mask,
 n, xb, yb, xe, ye, height, angle, thickness,
 x1, y1, alpha1, s1, mat1,
 ...
 xn, yn, alphan, sn, matn

CROOF_{4} is an extension of the CROOF_{3} command with the possibility of using inline material definition, that means materials defined in GDL script locally also can be used next to materials defined in global material definitions.

MESH

MESH a, b, m, n, mask,
 z11, z12, ..., z1m,
 z21, z22, ..., z2m,
 ...
 zn1, zn2, ..., znm

A simple smooth mesh based on a rectangle with an equidistant net. The sides of the base rectangle are a and b; the m and n points are along the x and y axes respectively; z_{ij} is the height of the node.

Masking:

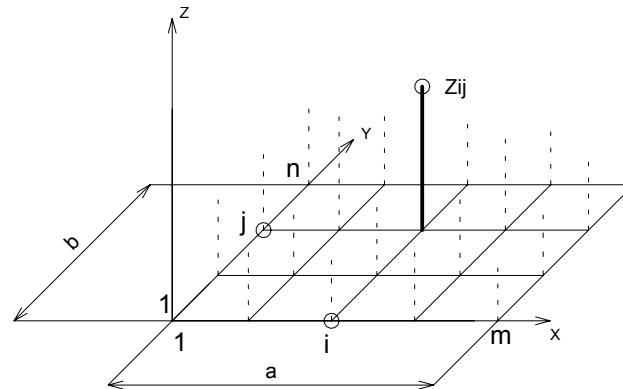

mask :

$\text{mask} = j_1 + 4*j_3 + 16*j_5 + 32*j_6 + 64*j_7$, where each j can be 0 or 1.

j_1 : base surface is present,

j_3 : side surfaces are present,
 j_5 : base and side edges are visible,
 j_6 : top edges are visible,
 j_7 : top edges are visible, top surface is not smooth.

Restriction of parameters:

$m \geq 2, n \geq 2$

Example 1:

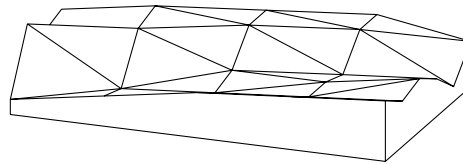

```

MESH 50, 30, 5, 6, 1+4+16+32+64,
      2, 4, 6, 7, 8,
      10, 3, 4, 5, 6,
      7, 9, 5, 5, 7,
      8, 10, 9, 4, 5,
      6, 7, 9, 8, 2,
      4, 5, 6, 8, 6
  
```

Example 2:

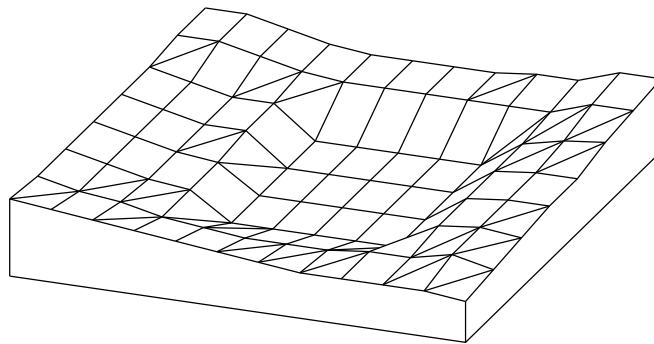

```

MESH 90, 100, 12, 8, 1+4+16+32+64,
17,16,15,14,13,12,11,10,10,10,10, 9,
16,14,13,11,10, 9, 9, 9,10,10,12,10,
16,14,12,11, 5, 5, 5, 5, 5,11,12,11,
16,14,12,11, 5, 5, 5, 5, 5,11,12,12,
16,14,12,12, 5, 5, 5, 5, 5,11,12,12,
16,14,12,12, 5, 5, 5, 5, 5,11,13,14,
17,17,15,13,12,12,12,12,12,12,15,15,
17,17,15,13,12,12,12,12,13,13,16,16

```

ARMC

ARMC r1, r2, l, h, d, alpha

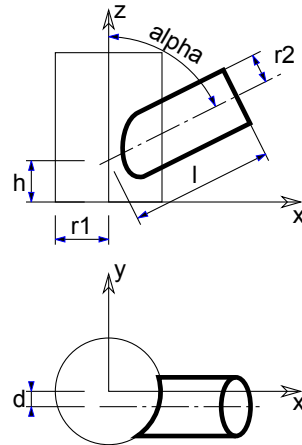

A piece of tube starting from another tube; parameters according to the figure (penetration curves are also calculated and drawn). The alpha value is in degrees.

Restriction of parameters:

$$\begin{aligned}
 r1 &\geq r2 + d \\
 r1 &\leq l \cdot \sin(\alpha) - r2 \cdot \cos(\alpha)
 \end{aligned}$$

Example:

```

ROTY 90
CYLIND 10,1
ADDZ 6
ARMC 1, 0.9, 3, 0, 0, 45
ADDZ -1
ROTZ -90
ARMC 1, 0.75, 3, 0, 0, 90
ADDZ -1
ROTZ -90
ARMC 1, 0.6, 3, 0, 0, 135

```

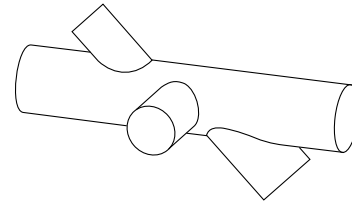

ARME

ARME 1, r1, r2, h, d

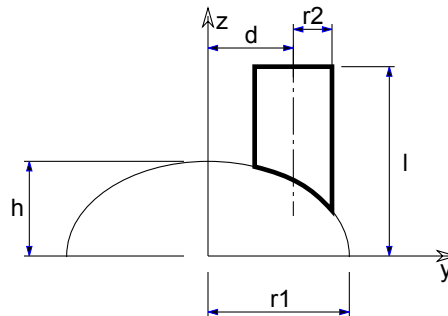

A piece of tube starting from an ellipsoid in the y-z plane; parameters according to the figure (penetration lines are also calculated and drawn).

Restriction of parameters:

$$r1 \geq r2 + d$$

$$l \geq h \cdot \sqrt{1 - (r2 - d)^2 / r1^2}$$

Example:

```

ELLIPS 3,4
FOR i=1 TO 6
  ARME 6,4,0.5,3,3.7-0.2*i
  ROTZ 30
NEXT i

```

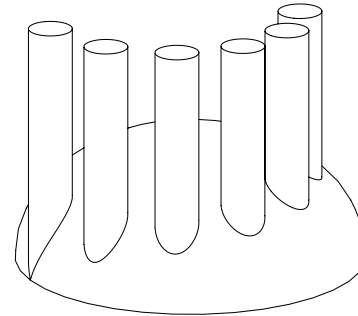

ELBOW

ELBOW $r1$, α , $r2$

A segmented elbow in the x-z plane. The radius of the arc is $r1$, the angle is α and the radius of the tube segment is $r2$. The α value is in degrees.

Restriction of parameters:

$$r1 > r2$$

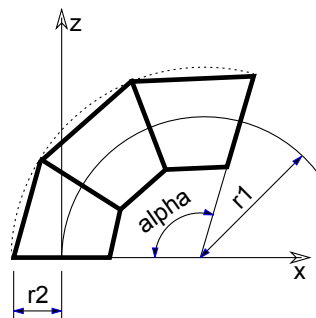

Example:

```

ROTY 90
ELBOW 2.5, 180, 1
ADDZ -4
CYLIND 4, 1
ROTZ -90
MULZ -1
ELBOW 5, 180, 1
DEL 1
ADDX 10
CYLIND 4, 1
ADDZ 4
ROTZ 90
ELBOW 2.5, 180, 1

```

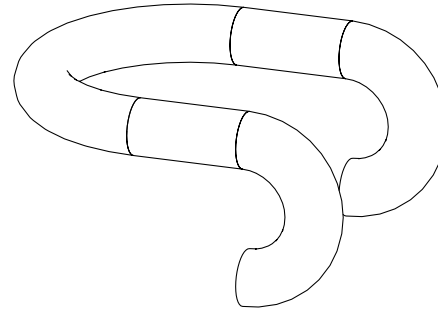

PLANAR SHAPES IN 3D

The drawing elements presented in this section can be used in 3D scripts, allowing you to define points, lines, arcs, circles and planar polygons in the three-dimensional space.

HOTSPOT

HOTSPOT *x, y, z* [, unID [, paramReference [, flags [, displayParam [, customDescription]]]]]

A 3D hotspot in the point (*x, y, z*).

unID: the unique identifier of the hotspot in the 3D script. It is useful if you have a variable number of hotspots.

paramReference: parameter that can be edited by this hotspot using the graphical hotspot based parameter editing method.

displayParam: parameter to display in the information palette when editing the paramReference parameter. Members of arrays can be passed as well.

customDescription: custom description of the displayed parameter in the information palette. When using this option, displayParam must be set as well (use paramReference for default).

See Graphical Editing Using Hotspots for using HOTSPOT.

HOTLINE

HOTLINE *x1, y1, z1, x2, y2, z2, unID*

A status line segment between the points P1 (x_1, y_1, z_1) and P2 (x_2, y_2, z_2).

HOTARC

HOTARC r , α , β , $unID$

A status arc in the x-y plane with its center at the origin from angle α to β with a radius of r .

Alpha and beta are in degrees.

LIN_

LIN_ x_1 , y_1 , z_1 , x_2 , y_2 , z_2

A line segment between the points P1 (x_1, y_1, z_1) and P2 (x_2, y_2, z_2).

RECT

RECT a , b

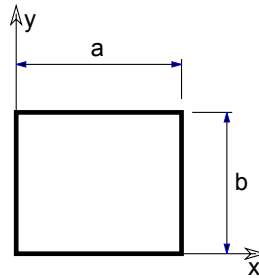

A rectangle in the x-y plane with sides a and b .

Restriction of parameters:

$$a \geq 0, b \geq 0$$

POLY

POLY n , x_1 , y_1 , \dots , x_n , y_n

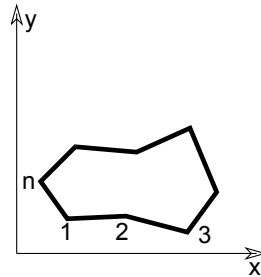

A polygon with n edges in the x - y plane. The coordinates of node i are $(x_i, y_i, 0)$.

Restriction of parameters:

$$n \geq 3$$

POLY_

POLY_ $n, x_1, y_1, s_1, \dots, x_n, y_n, s_n$

Similar to the normal POLY statement, but any of the edges can be omitted.

si: status code that allows you to control the visibility of polygon edges and side surfaces. You can also define holes and create segments and arcs in the polyline using special constraints.

si = 0: the edge starting from the (x_i, y_i) apex will be omitted,

si = 1: the edge will be shown,

si = -1: is used to define holes directly.

Additional status codes allow you to create segments and arcs in the planar polyline using special constraints.

See the section called "Additional Status Codes" for details.

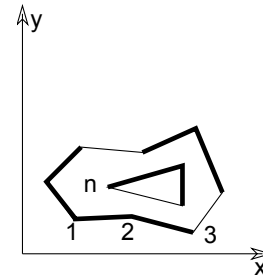
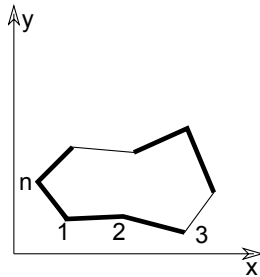

Restriction of parameters:

$$n \geq 3$$

PLANE

PLANE $n, x_1, y_1, z_1, \dots, x_n, y_n, z_n$

A polygon with n edges on an arbitrary plane. The coordinates of node i are (x_i, y_i, z_i) . The polygon must be planar in order to get a correct shading/rendering result, but the interpreter does not check this condition.

Restriction of parameters:

$$n \geq 3$$

PLANE_

PLANE_ $n, x_1, y_1, z_1, s_1, \dots, x_n, y_n, z_n, s_n$

Similar to the PLANE command, but any of the edges can be omitted as in the POLY_ command.

Additional status codes allow you to create segments and arcs in the planar polyline using special constraints.

See the section called "Additional Status Codes".

Restriction of parameters:

$$n \geq 3$$

CIRCLE

CIRCLE r

A circle in the x - y plane with its center at the origin and with a radius of r .

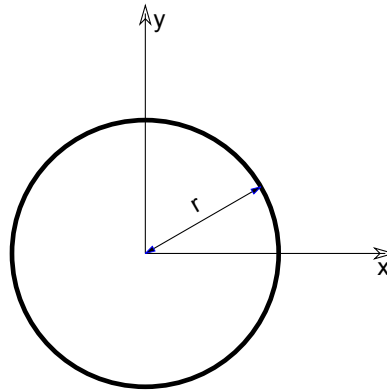

ARC

ARC r , α , β

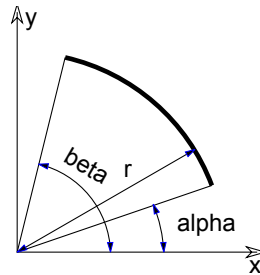

An arc (in Wireframe mode) or sector (in other modes) in the x-y plane with its center at the origin from angle α to β with a radius of r . α and β are in degrees.

SHAPES GENERATED FROM POLYLINES

These elements let you create complex 3D shapes using a polyline and a built-in rule. You can rotate, project or translate the given polyline. The resulting bodies are a generalization of some previously described elements like PRISM_ and CYLIND.

Shapes generated from a single polyline:

- EXTRUDE
- PYRAMID
- REVOLVE

Shapes generated from two polylines:

- RULED
- SWEEP
- TUBE
- TUBEA

The first polyline is always in the x-y plane. Points are determined by two coordinates; the third value is the status (see below). The second polyline (for RULED, SWEEP, TUBE and TUBEA) is a space curve. Apices are determined by three coordinate values.

Shape generated from four polylines:

- COONS

Shape generated from any number of polylines:

- MASS

General restrictions for polylines

- Adjacent vertices must not be coincident (except RULED).
- The polyline must not intersect itself (this is not checked by the program, but hidden line removal and rendering will be incorrect).
- The polylines may be either open or closed. In the latter case, the first node must be repeated after the last one of the contour.

Masking

Mask values are used to show or hide characteristic surfaces and/or edges of the 3D shape. The mask values are specific to each element and you can find a more detailed description in their corresponding sections/chapters.

mask :

$\text{mask} = j_1 + 2*j_2 + 4*j_3 + 8*j_4 + 16*j_5 + 32*j_6 + 64*j_7$, where each j can be 0 or 1.

j_1, j_2, j_3, j_4 represent whether the surfaces are present (1) or omitted (0).

j_5, j_6, j_7 represent whether the edges are visible (1) or invisible (0).

j_1 : base surface.

j_2 : top surface.

j_3 : side surface.

j_4 : other side surface.

j_5 : base edges.

j_6 : top edges.

j_7 : cross-section/surface edges are visible, surface is not smooth.

To enable all faces and edges, set mask value to 127.

Status

Status values are used to state whether a given point of the polyline will leave a sharp trace of its rotation path behind.

0: latitudinal arcs/lateral edges starting from the node are all visible.

1: latitudinal arcs/lateral edges starting from the node are used only for showing the contour.

-1: for EXTRUDE only: it marks the end of the enclosing polygon or a hole, and means that the next node will be the first node of another hole.

Additional status codes allow you to create segments and arcs in the polyline using special constraints.

See the section called “Additional Status Codes” for details.

To create a smooth 3D shape, set all status values to 1. Use status = 0 to create a ridge.

Other values are reserved for future enhancements.

EXTRUDE

EXTRUDE $n, dx, dy, dz, mask,$
 $x_1, y_1, s_1,$
 \dots
 x_n, y_n, s_n

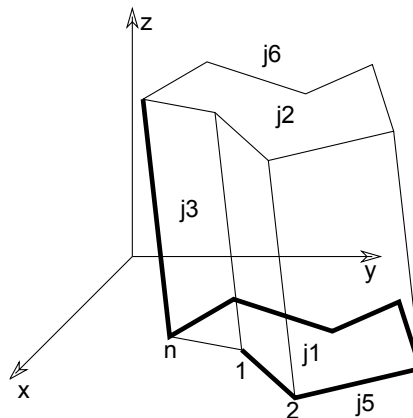

General prism using a polyline base in the x-y plane.

The displacement vector between bases is (dx, dy, dz). This is a generalization of the PRISM command and the SLAB command. The base polyline is not necessarily closed, as the lateral edges are not always perpendicular to the x-y plane. The base polyline may include holes, just like PRISM_. It is possible to control the visibility of the contour edges.

n: the number of polyline nodes.

mask: controls the existence of the bottom, top and (in case of an open polyline) side polygon.

$mask = j_1 + 2*j_2 + 4*j_3 + 16*j_5 + 32*j_6 + 64*j_7 + 128*j_8$, where each j can be 0 or 1.

j_1 : base surface is present,

j_2 : top surface is present,

j_3 : side (closing) surface is present,

j_5 : base edges are visible,

j_6 : top edges are visible.

j_7 : cross-section edges are visible, surface is articulated,

j_8 : cross-section edges are sharp, the surface smoothing will stop here in OpenGL and rendering.

si: status of the lateral edges or marks the end of the polygon or of a hole. You can also define arcs and segments in the polyline using additional status code values:

0: lateral edge starting from the node is visible,

1: lateral edges starting from the node are used for showing the contour,

-1: marks the end of the enclosing polygon or a hole, and means that the next node will be the first vertex of another hole.

Additional status codes allow you to create segments and arcs in the planar polyline using special constraints.

See the section called "Additional Status Codes" for details.

Restriction of parameters:

$n > 2$

Example 1:

```
EXTRUDE 14, 1, 1, 4, 1+2+4+16+32,  
0, 0, 0,  
1, -3, 0,  
2, -2, 1,  
3, -4, 0,  
4, -2, 1,  
5, -3, 0,  
6, 0, 0,  
3, 4, 0,  
0, 0, -1,  
2, 0, 0,  
3, 2, 0,  
4, 0, 0,  
3, -2, 0,  
2, 0, -1
```

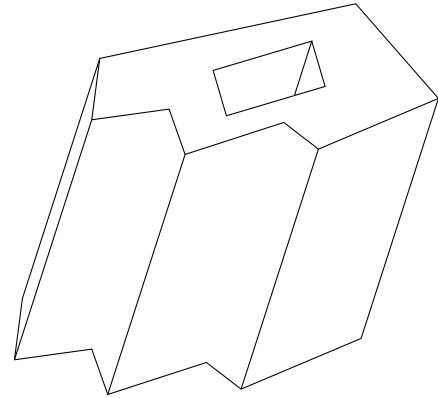

Example 2:

```

A=5: B=5: R=2: S=1: C=R-S : D=A-R : E=B-R
EXTRUDE 28, -1, 0, 4, 1+2+4+16+32,
0, 0, 0,
D+R*sin(0), R-R*cos(0), 1,
D+R*sin(15), R-R*cos(15), 1,
D+R*sin(30), R-R*cos(30), 1,
D+R*sin(45), R-R*cos(45), 1,
D+R*sin(60), R-R*cos(60), 1,
D+R*sin(75), R-R*cos(75), 1,
D+R*sin(90), R-R*cos(90), 1,
A, B, 0,
0, B, 0,
0, 0, -1,
C, C, 0,
D+S*sin(0), R-S*cos(0), 1,
D+S*sin(15), R-S*cos(15), 1,
D+S*sin(30), R-S*cos(30), 1,
D+S*sin(45), R-S*cos(45), 1,
D+S*sin(60), R-S*cos(60), 1,
D+S*sin(75), R-S*cos(75), 1,
D+S*sin(90), R-S*cos(90), 1,
A-C, B-C, 0,
R-S*cos(90), E+S*sin(90), 1,
R-S*cos(75), E+S*sin(75), 1,
R-S*cos(60), E+S*sin(60), 1,
R-S*cos(45), E+S*sin(45), 1,
R-S*cos(30), E+S*sin(30), 1,
R-S*cos(15), E+S*sin(15), 1,
R-S*cos(0), E+S*sin(0), 1,
C, C, -1

```

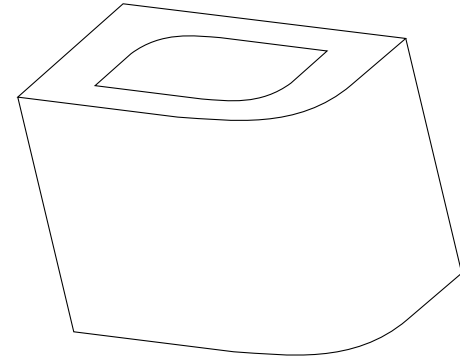

PYRAMID

PYRAMID *n*, *h*, *mask*, *x1*, *y1*, *s1*, ..., *xn*, *yn*, *sn*

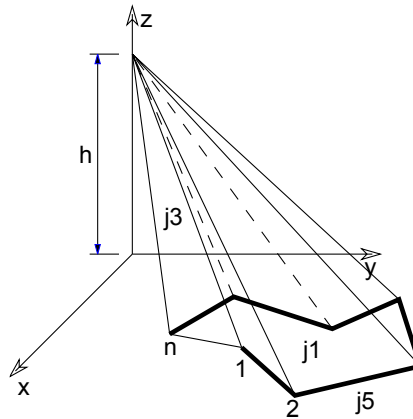

Pyramid based on a polyline in the x-y plane. The peak of the pyramid is located at $(0, 0, h)$.

n: number of polyline nodes.

mask: controls the existence of the bottom and (in the case of an open polyline) side polygon.

$mask = j_1 + 4*j_3 + 16*j_5$, where each j can be 0 or 1.

j_1 : base surface is present,

j_3 : side (closing) surface is present,

j_5 : base edges are visible.

si: status of the lateral edges.

0: lateral edges starting from the node are all visible,

1: lateral edges starting from the node are used for showing the contour.

Additional status codes allow you to create segments and arcs in the planar polyline using special constraints.

See the section called "Additional Status Codes" for details.

Restriction of parameters:

$h > 0$ and $n > 2$

Example:

```

PYRAMID 4, 1.5, 1+4+16,
  -2, -2, 0,
  -2, 2, 0,
  2, 2, 0,
  2, -2, 0
PYRAMID 4, 4, 21,
  -1, -1, 0,
  1, -1, 0,
  1, 1, 0,
  -1, 1, 0
for i = 1 to 4      ! four peaks
  ADD -1.4, -1.4, 0
  PYRAMID 4, 1.5, 21,
    -0.25, -0.25, 0,
    0.25, -0.25, 0,
    0.25, 0.25, 0,
    -0.25, 0.25, 0
  DEL 1
  ROTZ 90
next i
del 4

```

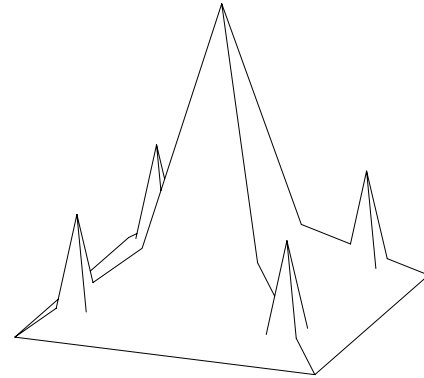

REVOLVE

REVOLVE *n*, *alpha*, *mask*, *x1*, *y1*, *s1*, ..., *xn*, *yn*, *sn*

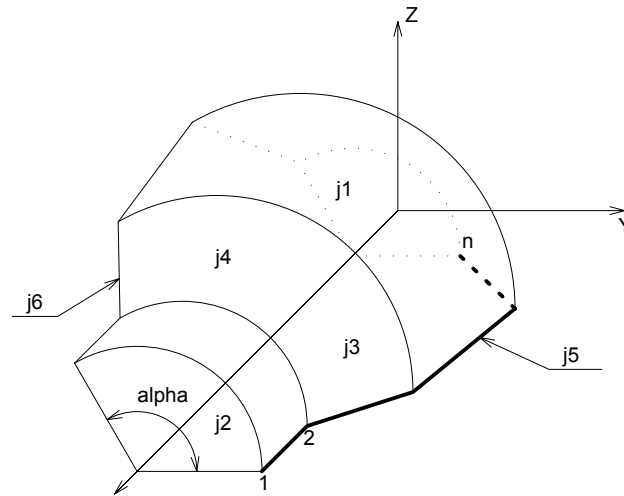

Surface generated by rotating a polyline defined in the x-y plane around the x axis. The profile polyline cannot contain holes.

n: number of polyline nodes.

alpha: rotation angle in degrees

mask: controls the existence of the bottom, top and (in the case of $\alpha < 360^\circ$) side polygons.

$\text{mask} = j_1 + 2*j_2 + 4*j_3 + 8*j_4 + 16*j_5 + 32*j_6 + 64*j_7 + 128*j_8 + 256*j_9$, where each j can be 0 or 1.

j_1 : closing disc at first point is present,

j_2 : closing disc at last point is present,

j_3 : base closing side (in profile plane) is present,

j_4 : end closing side (in revolved plane) is present,

j_5 : base edges (in profile plane) are visible,

j_6 : end edges (in revolved plane) are visible,

j_7 : cross-section edges are visible, surface is articulated,

j_8 : horizontal edge in line elimination,

j_9 : vertical edge in line elimination.

si: status of the latitudinal arcs.

0: latitudinal arcs starting from the node are all visible,

- 1: latitudinal arcs starting from the node are used for showing the contour,
- 2: when using ARCHICAD or Z-buffer Rendering Engine and setting Smooth Surfaces, the latitudinal edge belonging to this point defines a break. This solution is equivalent to the definition of additional nodes. The calculation is performed by the compiler. With other rendering methods, it has the same effect as using 0.

Additional status codes allow you to create segments and arcs in the planar polyline using special constraints.

See the section called “Additional Status Codes” for details.

Restriction of parameters:

$$n \geq 2$$

$$y_i \geq 0.0$$

$$y_i = 0.0 \text{ and } y_{i+1} = 0.0 \text{ cannot stand at the same time}$$

(i.e., the y value of two neighboring nodes cannot be zero at the same time).

Example 1:

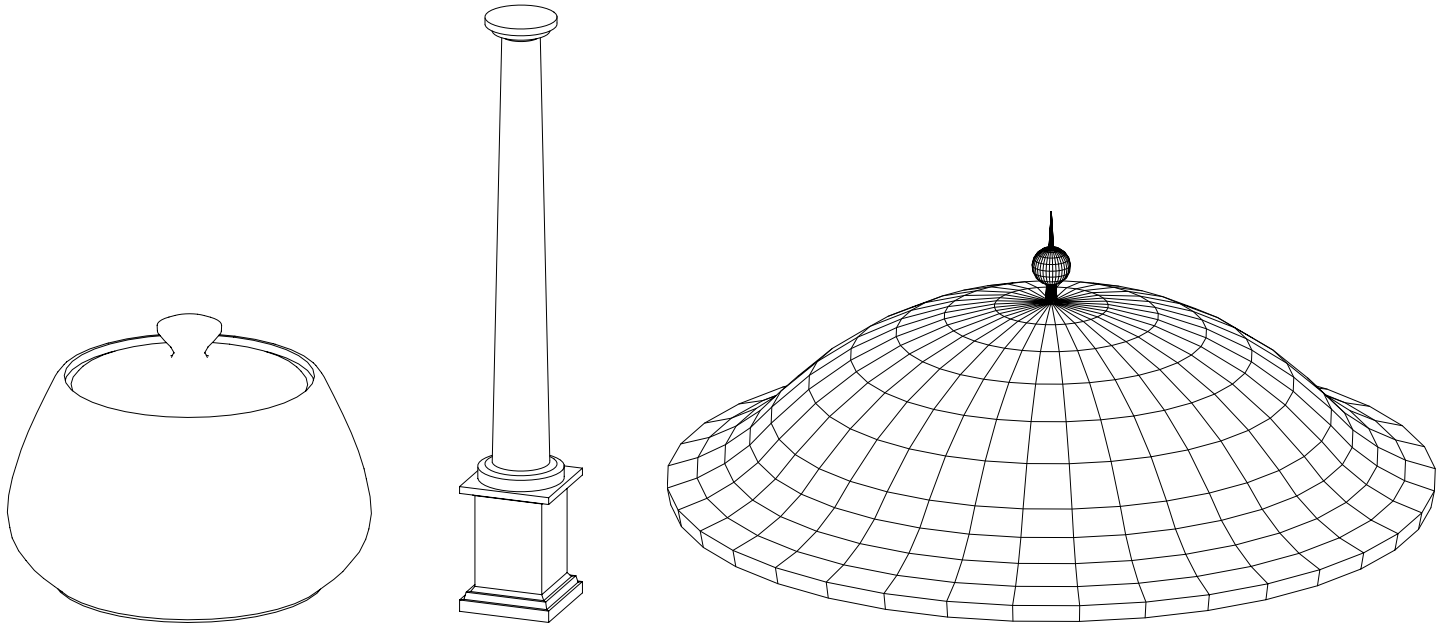

```
ROTY -90
REVOLVE 22, 360, 1+64,
         0, 1.982, 0,
         0.093, 2, 0,
         0.144, 1.845, 0,
         0.220, 1.701, 0,
         0.318, 1.571, 0,
         0.436, 1.459, 0,
         0.617, 1.263, 0,
         0.772, 1.045, 0,
         0.896, 0.808, 0,
         0.987, 0.557, 0,
         1.044, 0.296, 0,
         1.064, 0.030, 0,
         1.167, 0.024, 0,
         1.181, 0.056, 0,
         1.205, 0.081, 0,
         1.236, 0.096, 0,
         1.270, 0.1, 0,
         1.304, 0.092, 0,
         1.333, 0.073, 0,
         1.354, 0.045, 0,
         1.364, 0.012, 0,
         1.564, 0, 0
```

Example 2:

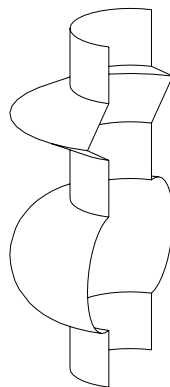

workaround without status code 2:

```

ROTY -90
REVOLVE 26, 180, 16+32,
        7, 1, 0,
        6.0001, 1, 1,
        6, 1, 0,
        5.9999, 1.0002, 1,
        5.5001, 1.9998, 1,
        5.5, 2, 0,
        5.4999, 1.9998, 1,
        5.0001, 1.0002, 1,
        5, 1, 0,
        4.9999, 1, 1,
        4.0001, 1, 1,
        4, 1, 0,
        3+cos(15), 1+sin(15), 1,
        3+cos(30), 1+sin(30), 1,
        3+cos(45), 1+sin(45), 1,
        3+cos(60), 1+sin(60), 1,
        3+cos(75), 1+sin(75), 1,
        3, 2, 1,
        3+cos(105), 1+sin(105), 1,
        3+cos(120), 1+sin(120), 1,
        3+cos(135), 1+sin(135), 1,
        3+cos(150), 1+sin(150), 1,
        3+cos(165), 1+sin(165), 1,
        2, 1, 0,
        1.9999, 1, 0,
        1, 1, 0

```

the same result with status code 2:

```

ROTY -90
REVOLVE 18, 180, 48,
        7, 1, 0,
        6, 1, 2,
        5.5, 2, 2,
        5, 1, 2,
        4, 1, 2,
        3+cos(15), 1+sin(15), 1,
        3+cos(30), 1+sin(30), 1,
        3+cos(45), 1+sin(45), 1,
        3+cos(60), 1+sin(60), 1,
        3+cos(75), 1+sin(75), 1,
        3, 2, 1,
        3+cos(105), 1+sin(105), 1,
        3+cos(120), 1+sin(120), 1,
        3+cos(135), 1+sin(135), 1,
        3+cos(150), 1+sin(150), 1,
        3+cos(165), 1+sin(165), 1,
        2, 1, 2,
        1, 1, 0

```

REVOLVE{2}

REVOLVE{2} *n*, *alphaOffset*, *alpha*, *mask*, *sideMat*,
x1, *y1*, *s1*, *mat1*, ..., *xn*, *yn*, *sn*, *matn*

Advanced version of REVOLVE. The profile polygon will always be closed and may have holes. The start angle and the face materials are controllable.

alphaOffset: rotation start angle.

alpha: rotation angle length in degrees, may be negative.

mask: controls the existence of the bottom, top and (in the case of $\alpha < 360^\circ$) side polygons.

$\text{mask} = 4*j_3 + 8*j_4 + 16*j_5 + 32*j_6 + 64*j_7 + 128*j_8 + 256*j_9$, where each j can be 0 or 1.

j_3 : base closing side (in profile plane) is present,

j_4 : end closing side (in revolved plane) is present,

j_5 : base edges (in profile plane) are visible,

j_6 : end edges (in revolved plane) are visible,

j_7 : cross-section edges are visible, surface is articulated,

j_8 : horizontal edge in line elimination,

j_9 : vertical edge in line elimination.

sideMat: material of the closing faces.

mati: material of the face generated from the i -th edge.

REVOLVE{3}

REVOLVE{3} n , alphaOffset, alpha, betaOffset, beta, mask, sideMat,
x1, y1, s1, mat1, ..., xn, yn, sn, matn

REVOLVE{3} is an extension of the REVOLVE{2} command with the possibility of defining two snap position. During the revolution the path of each point of the base polyline is a circular arc, which is approximated by a polyline. With REVOLVE{3} two snap location can be defined where polyline exactly fits the circle. With REVOLVE{2} this two snap locations are at the beginning and the end of the revolution. With REVOLVE{3} the end points are not necessarily on the circle but simply cut at end planes.

betaOffset: Angle defining the first snap location. The defined angle need not be in the range of revolution.

beta: Angle defining the second snap location relative to the first snap location. May be negative. The defined angle need not be in the range of revolution.

Example:

revolve{2} snap positions at ends

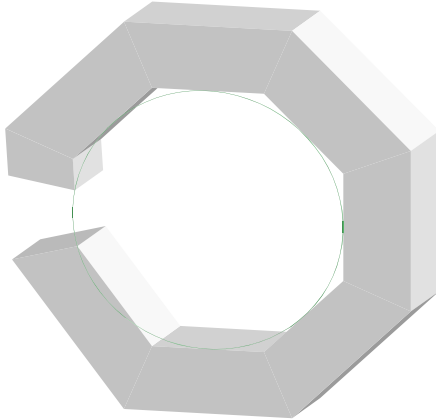

```

resol 8
revolve{2} 4,
  10, 335,    ! alphaOffset, alpha
  444, 2,
  0, 4, 2, 2,
  3, 4, 2, 2,
  3, 6, 2, 2,
  0, 6, 2, 2
! reference circle
resol 72
revolve{2} 4,
  0, 360,    ! alphaOffset, alpha
  444, 0,
  -0.01, 3.99, 2, 0,
  0, 3.99, 2, 0,
  0, 4, 2, 0,
  -0.01, 4, 2, 0

```

revolve{3} custom snap positions

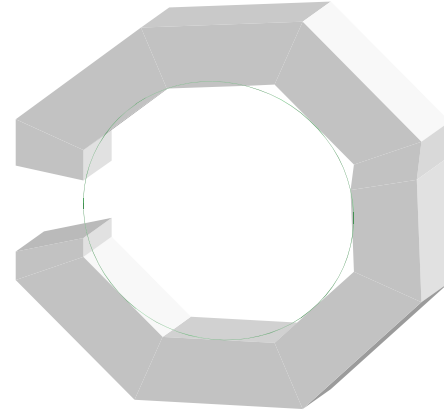

```

resol 8
revolve{3} 4,
  10, 335,    ! alphaOffset, alpha
  67.5, 100,  ! betaOffset, beta
  444, 2,
  0, 4, 2, 2,
  3, 4, 2, 2,
  3, 6, 2, 2,
  0, 6, 2, 2
! reference circle
resol 72
revolve{2} 4,
  0, 360,    ! alphaOffset, alpha
  444, 0,
  -0.01, 3.99, 2, 0,
  0, 3.99, 2, 0,
  0, 4, 2, 0,
  -0.01, 4, 2, 0

```

REVOLVE{4}

REVOLVE{4} *n*, alphaOffset, alpha, betaOffset, beta, mask, sideMat,
x1, y1, s1, mat1, ..., xn, yn, sn, matn

REVOLVE{4} is an extension of the REVOLVE{3} command with the possibility of hiding all edges.

mask: controls the existence of the bottom, top and (in the case of $\alpha < 360^\circ$) side polygons.

mask = $4*j_3 + 8*j_4 + 16*j_5 + 32*j_6 + 64*j_7 + 128*j_8 + 256*j_9 + 512*j_{10} + 1024*j_{11}$, where each *j* can be 0 or 1.

*j*₃: base closing side (in profile plane) is present,

*j*₄: end closing side (in revolved plane) is present,

*j*₅: base edges (in profile plane) are visible,

*j*₆: end edges (in revolved plane) are visible,

*j*₇: cross-section edges are visible, surface is articulated,

*j*₈: horizontal edge in line elimination,

*j*₉: vertical edge in line elimination,

*j*₁₀: hide all edges of revolve,

*j*₁₁: side edge and surface is smooth in curved sections of the profile. *Compatibility: introduced in ARCHICAD 21.*

REVOLVE{5}

REVOLVE{5} *n*, alphaOffset, alpha, betaOffset, beta, mask, sideMat,
x1, y1, s1, mat1, ..., xn, yn, sn, matn

REVOLVE{5} is an extension of the REVOLVE{4} command with the possibility of using inline material definition, that means materials defined in GDL script locally also can be used next to materials defined in global material definitions.

RULED

RULED *n*, mask,
u1, v1, s1, ..., un, vn, sn,
x1, y1, z1, ..., xn, yn, zn

RULED{2}

RULED{2} *n*, mask,
u1, v1, s1, ..., un, vn, sn,
x1, y1, z1, ..., xn, yn, zn

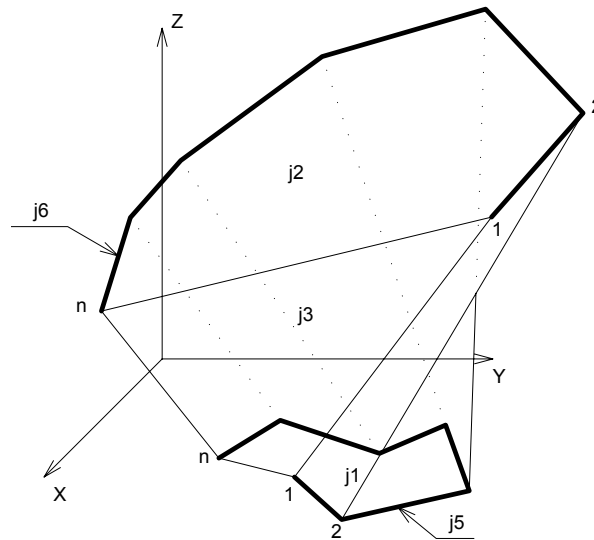

RULED is a surface based on a planar curve and a space curve having the same number of nodes. The planar curve polyline cannot have any holes. Straight segments connect the corresponding nodes of the two polylines.

This is the only GDL element allowing the neighboring nodes to overlap.

The second version, RULED{2}, checks the direction (clockwise or counterclockwise) in which the points of both the top polygon and base polygon were defined, and reverses the direction if necessary. (The original RULED command takes only the base polygon into account, which can lead to errors.)

n: number of polyline nodes in each curve.

ui, vi: coordinates of the planar curve nodes.

xi, yi, zi: coordinates of the space curve nodes.

mask: controls the existence of the bottom, top and side polygon and the visibility of the edges on the generator polylines. The side polygon connects the first and last nodes of the curves, if any of them are not closed.

$\text{mask} = j_1 + 2*j_2 + 4*j_3 + 16*j_5 + 32*j_6 + 64*j_7$, where each j can be 0 or 1.

j_1 : base surface is present,

j_2 : top surface is present (not effective if the top surface is not planar),

- j_3 : side surface is present (a planar quadrangle or two triangles),
- j_5 : edges on the planar curve are visible,
- j_6 : edges on the space curve are visible,
- j_7 : edges on the surface are visible, surface is not smooth.

si: status of the lateral edges.

- 0: lateral edges starting from the node are all visible,
- 1: lateral edges starting from the node are used for showing the contour.

Restriction of parameters:

$$n > 1$$

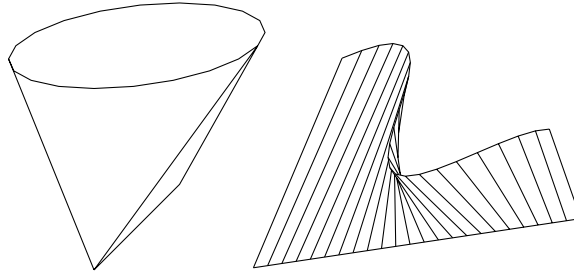

Example:

```

R=3
RULED 16, 1+2+4+16+32,
  cos(22.5)*R, sin(22.5)*R, 0,
  cos(45)*R, sin(45)*R, 0,
  cos(67.5)*R, sin(67.5)*R, 0,
  cos(90)*R, sin(90)*R, 0,
  cos(112.5)*R, sin(112.5)*R, 0,
  cos(135)*R, sin(135)*R, 0,
  cos(157.5)*R, sin(157.5)*R, 0,
  cos(180)*R, sin(180)*R, 0,
  cos(202.5)*R, sin(202.5)*R, 0,
  cos(225)*R, sin(225)*R, 0,
  cos(247.5)*R, sin(247.5)*R, 0,
  cos(270)*R, sin(270)*R, 0,
  cos(292.5)*R, sin(292.5)*R, 0,
  cos(315)*R, sin(315)*R, 0,
  cos(337.5)*R, sin(337.5)*R, 0,
  cos(360)*R, sin(360)*R, 0,
  cos(112.5)*R, sin(112.5)*R, 10,
  cos(135)*R, sin(135)*R, 10,
  cos(157.5)*R, sin(157.5)*R, 10,
  cos(180)*R, sin(180)*R, 10,
  cos(202.5)*R, sin(202.5)*R, 10,
  cos(225)*R, sin(225)*R, 10,
  cos(247.5)*R, sin(247.5)*R, 10,
  cos(270)*R, sin(270)*R, 10,
  cos(292.5)*R, sin(292.5)*R, 10,
  cos(315)*R, sin(315)*R, 10,
  cos(337.5)*R, sin(337.5)*R, 10,
  cos(360)*R, sin(360)*R, 10,
  cos(22.5)*R, sin(22.5)*R, 10,
  cos(45)*R, sin(45)*R, 10,
  cos(67.5)*R, sin(67.5)*R, 10,
  cos(90)*R, sin(90)*R, 10

```

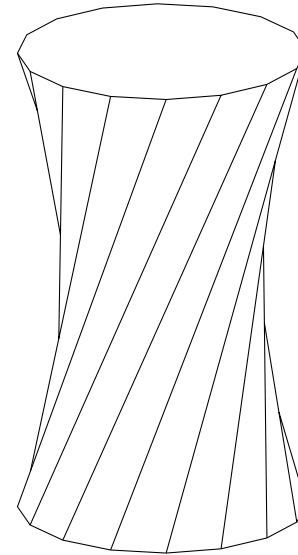

RULEDSEGMENTED

```
RULEDSEGMENTED n, mask,
    x11, y11, z11, s1, ..., x1n, y1n, z1n, sn,
    x21, y21, z21, ..., x2n, y2n, z2n
```

Compatibility: introduced in ARCHICAD 21.

RULEDSEGMENTED creates a surface based on two arbitrary-shaped polyline in 3D space. The two polylines must consist of the same number of vertices. It generates a sequence of doubly ruled surfaces, like **RULED**, but with less restriction on input polylines and with a subdivision of better quality.

Corresponding vertices of the two profiles are connected with straight lines. Corresponding pair of skew segments of the profiles are connected by a doubly ruled surface (mathematically hyperbolic paraboloid), with segmentation in both directions, resulting much smoother renderings and cross-sections.

Conditions of profile polylines:

- both are 3D polylines, does not need to be coplanar
- each may be closed but, neither may contain holes
- each may contain identical vertices, even multiple consecutive ones resulting in fan-shaped surface
- if a profile polyline is closed and coplanar, closing polygon can be generated

n: number of polyline nodes in each curve.

x1i, y1i, z1i: 3D positions of vertices on first profile polyline.

x2i, y2i, z2i: 3D positions of vertices on second profile polyline.

mask: controls the existence of the bottom, top and side polygon and the visibility of the edges on the generator polylines. The side polygon connects the first and last nodes of the curves, if any of them are not closed.

$\text{mask} = j_1 + 2*j_2 + 4*j_3 + 16*j_5 + 32*j_6 + 64*j_7$, where each j can be 0 or 1.

j_1 : base surface is present (not effective if the first polyline is not coplanar and j_3 is not set),

j_2 : top surface is present (not effective if the second polyline is not coplanar and j_3 is not set),

j_3 : closing side surface is present (surface on additional segments between the last and first nodes),

j_5 : edges on the first profile polyline are visible,

j_6 : edges on the second profile polyline are visible,

j_7 : edges on the surface are visible, surface is not smooth.

si: status of the generatrices (lateral edges between one node on first profile polyline and corresponding node on second polyline).

0: generatrix is visible,

1: generatrix is used for showing the contour,

2: generatrix visible and defines a break in rendering.

Restriction of parameters:

$n > 1$

Example:

```
RULEDSEGMENTED 4, 16+32,
                0, 0, 0, 2,
                1, 0, 0, 2,
                1, 1, 0, 2,
                1, 1, 1, 2,
                0, 0, 1,
                0, 1, 1,
                0, 1, 2,
                1, 2, 2
```

RULEDSEGMENTED{2}

RULEDSEGMENTED{2} top_material, bottom_material,
 n, mask, textureMode,
 x11, y11, z11, s1, mat1..., x1n, y1n, z1n, sn, matn,
 x21, y21, z21, ..., x2n, y2n, z2n

Compatibility: introduced in ARCHICAD 23.

RULEDSEGMENTED{2} is an extension of the RULEDSEGMENTED command with the possibility of controlling the surface attributes of the generated surfaces in segment detail and applying custom texture projection.

Additional parameters:

top_material: surface attribute index of the base surface (if the first polyline is coplanar and j1+j3 are set).

bottom_material: surface attribute index of the top surface (if the second polyline is coplanar and j2+j3 are set).

textureMode: texture projection mode

0: automatic, optimized for curved surfaces, the same as with the RULEDSEGMENTED command.

1: custom, defined by the COOR command.

mati: surface attribute index of generated surface segment i.

Example:

```

_topMatIndex = 22
_bottomMatIndex = 34
_segmentMatIndex_1 = 55
_segmentMatIndex_2 = 44

RULEDSEGMENTED{2} _topMatIndex, _bottomMatIndex,
    4, 1+2+16+32, 0,
    0, 0, 0, 2, _segmentMatIndex_1,
    1, 0, 0, 2, _segmentMatIndex_2,
    1, 1, 0, 2, _segmentMatIndex_1,
    0, 1, 0, 2, _segmentMatIndex_2,
    1, 0, 1,
    1, 1, 1,
    0, 1, 1,
    0, 0, 1

```

SWEEP

SWEEP *n*, *m*, *alpha*, *scale*, *mask*,
u1, *v1*, *s1*, ..., *un*, *vn*, *sn*,
x1, *y1*, *z1*, ..., *xm*, *ym*, *zm*

Surface generated by a polyline sweeping along a polyline space curve path.

The plane of the polyline follows the path curve. The space curve has to start from the x-y plane. If this condition is not met, it is moved along the z axis to start on the x-y plane.

The cross-section at point (*xi*, *yi*, *zi*) is perpendicular to the space curve segment between points (*xi-1*, *yi-1*, *zi-1*) and (*xi*, *yi*, *zi*).

SWEEP can be used to model the spout of a teapot and other complex shapes.

n: number of polyline nodes.

m: number of path nodes.

alpha: incremental polyline rotation on its own plane, from one path node to the next one.

scale: incremental polyline scale factor, from one path node to the next one.

ui, **vi**: coordinates of the base polyline nodes.

xi, **yi**, **zi**: coordinates of the path curve nodes.

mask: controls the existence of the bottom and top polygons' surfaces and edges.

$\text{mask} = j_1 + 2*j_2 + 4*j_3 + 16*j_5 + 32*j_6 + 64*j_7$, where each j can be 0 or 1.

j_1 : base surface is present,

j_2 : top surface is present,

j_3 : side surface is present,

j_5 : base edges are visible,

j_6 : top edges are visible,

j_7 : cross-section edges are visible, surface is articulated.

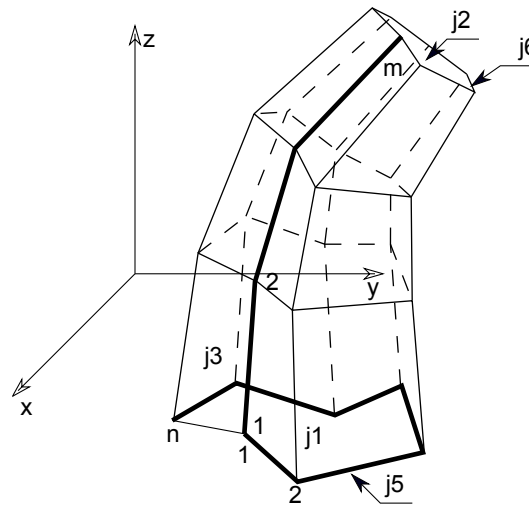

si: status of the lateral edges.

0: lateral edges starting from the node are all visible,

1: lateral edges starting from the node are used for showing the contour.

Additional status codes allow you to create segments and arcs in the planar polyline using special constraints.

See the section called "Additional Status Codes" for details.

Restriction of parameters:

```
n > 1
m > 1
z1 < z2
```

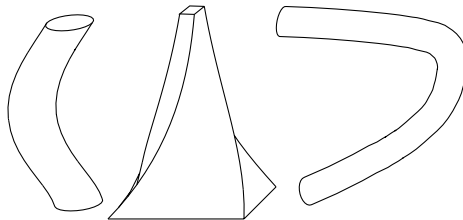

Example:

```
SWEEP 4, 12, 7.5, 1, 1+2+4+16+32,
-0.5, -0.25, 0,
0.5, -0.25, 0,
0.5, 0.25, 0,
-0.5, 0.25, 0,
0, 0, 0.5,
0, 0, 1,
0, 0, 1.5,
0, 0, 2,
0, 0, 2.5,
0, 0, 3,
0, 0, 3.5,
0, 0, 4,
0, 0, 4.5,
0, 0, 5,
0, 0, 5.5,
0, 0, 6
```

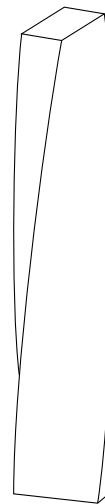

TUBE

```
TUBE n, m, mask,
      u1, w1, s1,
      ...
      un, wn, sn,
      x1, y1, z1, angle1,
      ...
      xm, ym, zm, anglem
```

Surface generated by a polyline sweeping along a space curve path without distortion of the generating cross-section. The internal connection surfaces are rotatable in the U-W plane of the instantaneous U-V-W coordinate system.

V axis: approximates the tangent of the generator curve at the corresponding point.

W axis: perpendicular to the V axis and pointing upward with respect to the local z axis.

U axis: perpendicular to the V and W axes and forms with them a right-hand sided Cartesian coordinate system.

If the V axis is vertical, then the W direction is not correctly defined. The W axis in the previous path node is used for determining a horizontal direction.

The cross-section polygon of the tube measured at the middle of the path segments is always equal to the base polygon (u1, w1, ..., un, wn).

Section polygons in joints are situated in the bisector plane of the joint segments. The base polygon must be closed.

n: number of the polyline nodes.

m: number of the path nodes.

ui, wi: coordinates of the base polyline nodes.

xi, yi, zi: coordinates of the path curve nodes.

anglei: rotation angle of the cross-section.

mask: controls the existence of the bottom and top polygons' surfaces and edges.

$mask = j_1 + 2*j_2 + 16*j_5 + 32*j_6 + 64*j_7 + 128*j_8 + 512*j_{10} + 1024*j_{11} + 2048*j_{12} + 4096*j_{13}$,
where each j can be 0 or 1.

j_1 : base surface is present,

j_2 : end surface is present,

j_5 : base edges (at x2, y2, z2) are visible,

j_6 : end edges (at xm-1, ym-1, zm-1) are visible,

j_7 : cross-section edges are visible, surface is articulated,

- j_8 : cross-section edges are sharp, the surface smoothing will stop here in OpenGL and rendering,
- j_{10} : base edges participate in line elimination (*Compatibility: introduced in ARCHICAD 23.*),
- j_{11} : end edges participate in line elimination (*Compatibility: introduced in ARCHICAD 23.*),
- j_{12} : longitudinal edges (which connect cross sections) participate in line elimination (*Compatibility: introduced in ARCHICAD 23.*),
- j_{13} : edges of cross sections participate in line elimination (*Compatibility: introduced in ARCHICAD 23.*).

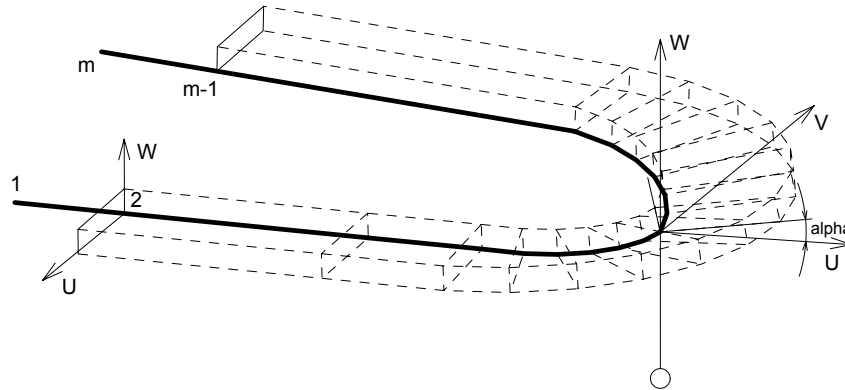

si: status of the lateral edges.

- 0: lateral edges starting from the node are all visible,
- 1: lateral edges starting from the node are used for showing the contour.
- 2: when using ARCHICAD or Z-buffer Rendering Engine and setting Smooth Surfaces, the lateral edge belonging to this point defines a break. This solution is equivalent to the definition of additional nodes. The calculation is performed by the compiler. With other rendering methods, it has the same effect as using 0.

Additional status codes allow you to create segments and arcs in the planar polyline using special constraints.

Note: The path comprises two points more than the number of generated sections. The first and the last points determine the position in space of the first and the last surfaces belonging to the TUBE. These points only play a role in determining the normal of the surfaces, they are not actual nodes of the path. The orientation of the surfaces is the same as that of the surfaces that would be generated at the nodes nearest to the two endpoints, if the TUBE were continued in the directions indicated by these.

Restriction of parameters:

- $n > 2$ and $m > 3$

Example 1:

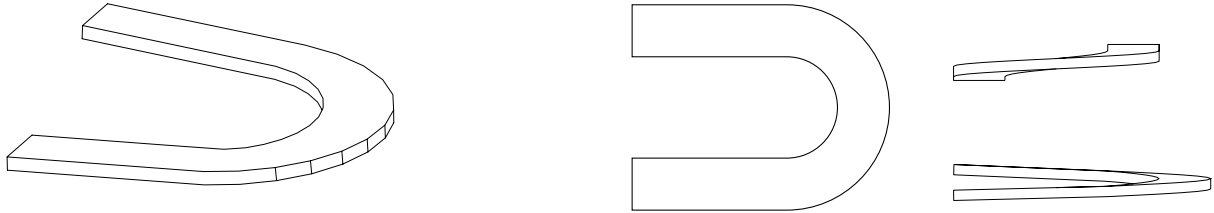

```
TUBE 4, 18, 16+32,
2.0, 0.0, 0,
0.0, 0.0, 0,
0.0, 0.4, 0,
2.0, 0.4, 0,
-1, 0, 0, 0,
0, 0, 0, 0,
4, 0, 0.1, 0,
6, 0, 0.15, 0,
6+4*sin(15), 4 - 4*cos(15), 0.2, 0,
6+4*sin(30), 4 - 4*cos(30), 0.25, 0,
6+4*sin(45), 4 - 4*cos(45), 0.3, 0,
6+4*sin(60), 4 - 4*cos(60), 0.35, 0,
6+4*sin(75), 4 - 4*cos(75), 0.4, 0,
10, 4, 0.45, 0,
6+4*sin(105), 4 - 4*cos(105), 0.5, 0,
6+4*sin(120), 4 - 4*cos(120), 0.55, 0,
6+4*sin(135), 4 - 4*cos(135), 0.6, 0,
6+4*sin(150), 4 - 4*cos(150), 0.65, 0,
6+4*sin(165), 4 - 4*cos(165), 0.7, 0,
6, 8, 0.75, 0,
0, 8, 1, 0,
-1, 8, 1, 0
```

Example 2:

```
TUBE 14, 6, 1+2+16+32,  
0, 0, 0,  
0.03, 0, 0,  
0.03, 0.02, 0,  
0.06, 0.02, 0,  
0.05, 0.0699, 0,  
0.05, 0.07, 1,  
0.05, 0.15, 901,  
1, 0, 801,  
0.08, 90, 2000,  
0.19, 0.15, 0,  
0.19, 0.19, 0,  
0.25, 0.19, 0,  
0.25, 0.25, 0,  
0, 0.25, 0,  
0, 1, 0, 0,  
0, 0.0001, 0, 0,  
0, 0, 0, 0,  
-0.8, 0, 0, 0,  
-0.8, 0.0001, 0, 0,  
-0.8, 1, 0, 0
```

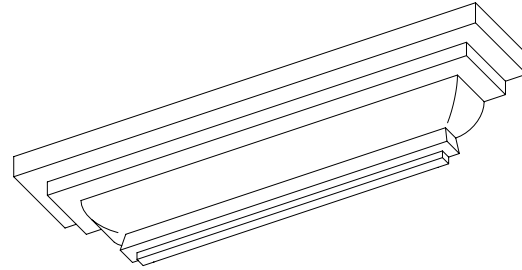

Example 3:

```
TUBE 3, 7, 16+32,
0, 0, 0,
-0.5, 0, 0,
0, 0.5, 0,
0.2, 0, -0.2, 0,
0, 0, 0, 0,
0, 0, 5, 0,
3, 0, 5, 0,
3, 4, 5, 0,
3, 4, 0, 0,
3, 3.8, -0.2, 0
```

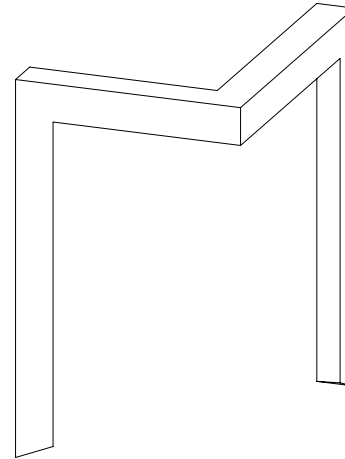

TUBE{2}

```
TUBE{2} top_material, bottom_material, cut_material,
n, m, mask,
u1, w1, s1, mat1,
...
un, wn, sn, matn,
x1, y1, z1, angle1,
...
xm, ym, zm, anglem
```

Compatibility: introduced in ARCHICAD 21. Extended version of the TUBE command:

- holes can be defined within the contour base polygon
- individual surfaces attribute for top, bottom polygons and cut areas
- individual surface attribute for side polygons belonging to the same base polygon edge

V axis, W axis, U axis: same meaning as in the TUBE command.

top_material: surface of the closing polygon.

bottom_material: surface of the starting polygon.

cut_material: surface of the cut areas.

n, m, ui, wi: same meaning as in the TUBE command.

xi, yi, zi, anglei: same meaning as in the TUBE command. Path can not contain arcs (segmentation is manual).

mask: controls the existence of the bottom and top polygons' surfaces and edges.

$mask = j_1 + 2*j_2 + 16*j_5 + 32*j_6 + 256*j_9 + 512*j_{10} + 1024*j_{11} + 2048*j_{12} + 4096*j_{13}$, where each j can be 0 or 1.

j_1 : base surface is present,

j_2 : end surface is present,

j_5 : base edges (at x_2, y_2, z_2) are visible,

j_6 : end edges (at $x_{m-1}, y_{m-1}, z_{m-1}$) are visible,

j_9 : side edge and surface is smooth in curved sections of the profile,

j_{10} : base edges participate in line elimination (*Compatibility: introduced in ARCHICAD 23.*),

j_{11} : end edges participate in line elimination (*Compatibility: introduced in ARCHICAD 23.*),

j_{12} : longitudinal edges (which connect cross sections) participate in line elimination (*Compatibility: introduced in ARCHICAD 23.*),

j_{13} : edges of cross sections participate in line elimination (*Compatibility: introduced in ARCHICAD 23.*).

si: status of the lateral edges.

-1: indicates the last node of a hole within the base polygon (duplicated first node of the hole), or the closing node of the outside polygon in case of a base polygon containing holes. The *matn* parameter is ignored in these duplicated nodes with status -1,

0, 1, 2: same meaning as in the TUBE command.

mati: individual surface of the side polygons belonging to the edge starting from *ui, wi* node of the base polygon.

Additional status codes allow you to create segments and arcs in the planar polyline using special constraints. Such polygon edges are automatically segmented during processing.

Example:

```

matEnds1 = 12
matEnds2 = 24
matCut = 15
matOuter = 10
matInner = 13

TUBE{2} matEnds1, matEnds2, matCut,
    10, 4, 1 + 2 + 16 + 32,

    ! outside contour
    -0.01, 0.01, 0, matOuter,
    -0.01, -0.01, 0, matOuter,
    0.01, -0.01, 0, matOuter,
    0.01, 0.01, 0, matOuter,
    -0.01, 0.01, -1, matOuter,

    ! hole contour
    -0.008, 0.008, 0, matInner,
    -0.008, -0.008, 0, matInner,
    0.008, -0.008, 0, matInner,
    0.008, 0.008, 0, matInner,
    -0.008, 0.008, -1, matInner,

    ! path
    0, 0, -1, 45,
    0, 0, 0, 45,
    0, 0, 1, 45,
    0, 0, 2, 45

```

TUBEA

```

TUBEA n, m, mask,
    u1, w1, s1,
    ...
    un, wn, sn,
    x1, y1, z1,
    ...
    xm, ym, zm

```

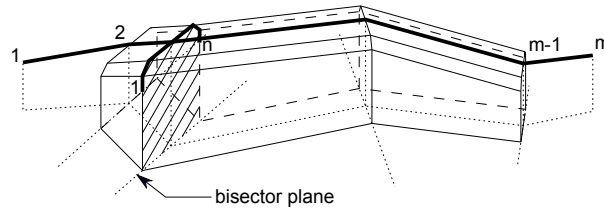



TUBE is a surface generated by a polyline sweeping along a space curve path with a different algorithm than that of the TUBE command. The section polygon generated in each joint of the path curve is equal with the base polygon ($u_1, w_1, \dots, u_n, w_n$) and is situated in the bisector plane of the projections of the joint segments to the local x-y plane. The base polygon can be opened: in this case the section polygons will be generated to reach the local x-y plane as in the case of REVOLVE surfaces.

The cross section of the tube measured at the middle of the path segments can be different from the base polygon.

Additional status codes allow you to create segments and arcs in the planar polyline using special constraints.

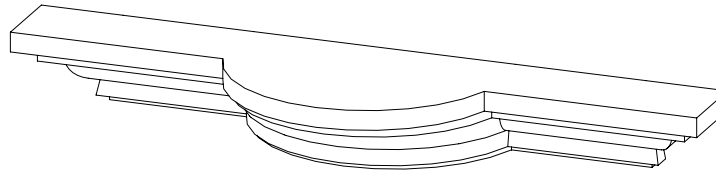
See the section called "Additional Status Codes" for details.



Example:

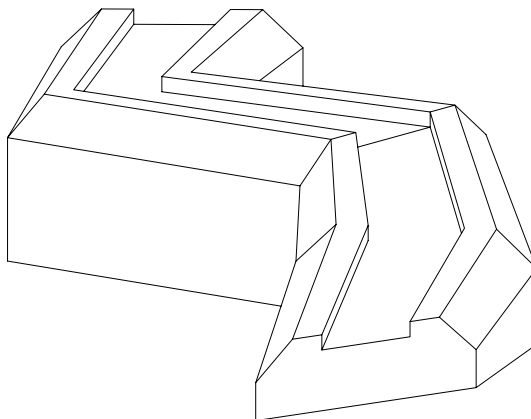

```
TUBE 9, 7, 1 + 2 + 16 + 32,  
-1, 1, 0,  
0, 2, 0,  
0.8, 2, 0,  
0.8, 1.6, 0,  
0.8001, 1.6, 1,  
3.2, 1.6, 0,  
3.2, 2, 0,  
4, 2, 0,  
5, 1, 0,  
0, -7, 0,  
0, 0, 0,  
4, 0, 1,  
9, 3, 2.25,  
9, 10, 2.25,  
14, 10, 2.25,  
20, 15, 5
```

COONS

COONS $n, m, \text{mask},$
 $x_{11}, y_{11}, z_{11}, \dots, x_{1n}, y_{1n}, z_{1n},$
 $x_{21}, y_{21}, z_{21}, \dots, x_{2n}, y_{2n}, z_{2n},$
 $x_{31}, y_{31}, z_{31}, \dots, x_{3m}, y_{3m}, z_{3m},$
 $x_{41}, y_{41}, z_{41}, \dots, x_{4m}, y_{4m}, z_{4m}$

A Coons patch generated from four boundary curves.

mask :

$\text{mask} = 4*j_3 + 8*j_4 + 16*j_5 + 32*j_6 + 64*j_7$, where each j can be 0 or 1.

j_3 : edges of the 1st boundary (x_1, y_1, z_1) are visible (effective only if j_7 is set),

j_4 : edges of the 2nd boundary (x_2, y_2, z_2) are visible (effective only if j_7 is set),

j_5 : edges of the 3rd boundary (x_3, y_3, z_3) are visible (effective only if j_7 is set),

j_6 : edges of the 4th boundary (x_4, y_4, z_4) are visible (effective only if j_7 is set),

j_7 : edges on surface are visible, surface is not smooth.

In case the edges on the surface are invisible (bit j_7 is set to zero), all boundary edges become visible, with the bits j_3 - j_6 becoming ineffective.

To define boundary edge visibility independent of surface edge visibility, use the `COONS{2}` command.

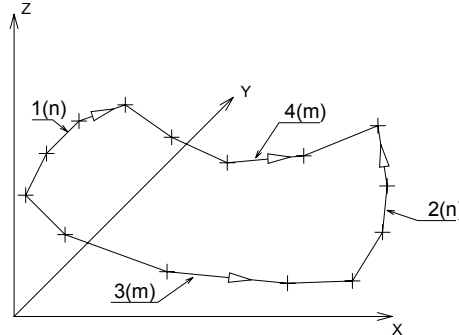

The orientation of the boundaries is obligatory: curves 1 and 2 must go from curve 3 towards 4, and curves 3 and 4 must go from curve 1 towards 2. The corner coordinates have to be the same in the respective curves.

Restriction of parameters:

$n > 1, m > 1$

Example 1:

```
COONS 6, 6, 4+8+16+32+64,  
! 1st boundary, n=6  
0, 0, 5,  
1, 0, 4,  
2, 0, 3,  
3, 0, 2,  
4, 0, 1,  
5, 0, 0,  
! 2nd boundary, n=6  
0, 5, 0,  
1, 5, 1,  
2, 5, 2,  
3, 5, 3,  
4, 5, 4,  
5, 5, 5,  
! 3rd boundary, m=6  
0, 0, 5,  
0, 1, 4,  
0, 2, 3,  
0, 3, 2,  
0, 4, 1,  
0, 5, 0,  
! 4th boundary, m=6  
5, 0, 0,  
5, 1, 1,  
5, 2, 2,  
5, 3, 3,  
5, 4, 4,  
5, 5, 5
```

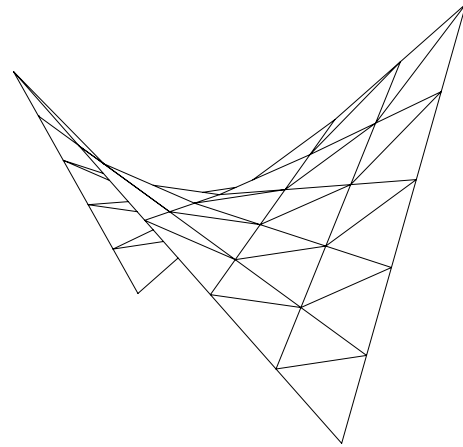

Example 2:

```

COONS 7, 6, 4+8+16+32+64,
! 1st boundary, n=7
1, 2, 0,
0.5, 1, 0,
0.2, 0.5, 0,
-0.5, 0, 0,
0.2, -0.5, 0,
0.5, -1, 0,
1, -2, 0,
! 2nd boundary, n=7
6, 10, -2,
6.5, 4, -1.5,
5, 1, -1.2,
4, 0, -1,
5, -1, -1.2,
6.5, -4, -1.5,
6, -10, -2,
! 3rd boundary, m=6
1, 2, 0,
2, 4, -0.5,
3, 6, -1,
4, 8, -1.5,
5, 9, -1.8,
6, 10, -2,
! 4th boundary, m=6
1, -2, 0,
2, -4, -0.5,
3, -6, -1,
4, -8, -1.5,
5, -9, -1.8,
6, -10, -2

```

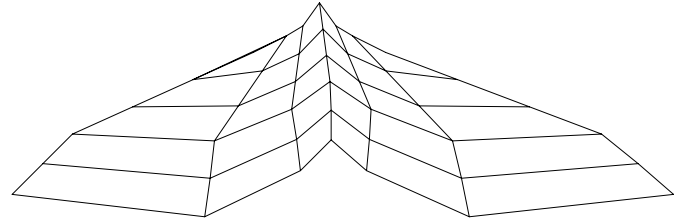

COONS{2}

```
COONS{2} n, m, mask,
         x11, y11, z11, ..., x1n, y1n, z1n,
         x21, y21, z21, ..., x2n, y2n, z2n,
         x31, y31, z31, ..., x3m, y3m, z3m,
         x41, y41, z41, ..., x4m, y4m, z4m
```

COONS{2} is an extension of the the COONS command with the possibility of setting the visibility of surface and boundary edges independently.

mask:

mask = $4*j_3 + 8*j_4 + 16*j_5 + 32*j_6 + 64*j_7$, where each j can be 0 or 1.

- j_3 : edges of the 1st boundary (x1, y1, z1) are visible,
- j_4 : edges of the 2nd boundary (x2, y2, z2) are visible,
- j_5 : edges of the 3rd boundary (x3, y3, z3) are visible,
- j_6 : edges of the 4th boundary (x4, y4, z4) are visible,
- j_7 : edges on surface are visible, surface is not smooth.

MASS

```
MASS top_material, bottom_material, side_material,
      n, m, mask, h,
      x1, y1, z1, s1,
      ...
      xn, yn, zn, sn,
      xn+1, yn+1, zn+1, sn+1,
      ...
      xn+m, yn+m, zn+m, sn+m
```

The equivalent of the shape generated by the Mesh tool in ARCHICAD.

top_material, bottom_material, side_material: name/index of the top, bottom and side materials.

n: the number of nodes in the mass polygon.

m: the number of nodes on the ridges.

h: the height of the skirt (can be negative).

xi, yi, zi: the coordinates of the nodes.

mask:

$\text{mask} = j_1 + 4*j_3 + 16*j_5 + 32*j_6 + 64*j_7 + 128*j_8$, where each j can be 0 or 1.

j_1 : base surface is present,

j_3 : side surfaces are present,

j_5 : base and side edges are visible,

j_6 : triangulation edges are visible,

j_7 : triangulation edges are visible, top surface is not smooth,

j_8 : all ridges will be sharp, but the surface is smooth.

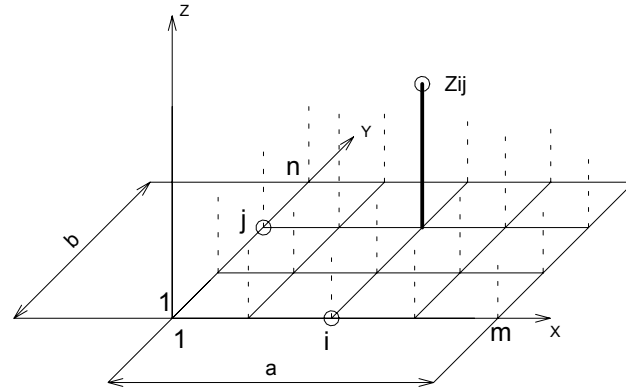

si: similar to the PRISM_ command. Additional status codes allow you to create segments and arcs in the planar polyline using special constraints.

See the section called "Additional Status Codes" for details.

Restriction of parameters:

$n \geq 3, m \geq 0$

Example:

```

MASS "Surf-White", "Surf-White", "Surf-White",
    15, 12, 117, -5.0,
    0, 12, 0, 15,
    8, 12, 0, 15,
    8, 0, 0, 15,
    13, 0, 0, 13,
    16, 0, 0, 13,
    19, 0, 0, 13,
    23, 0, 0, 13,
    24, 0, 0, 15,
    24, 12, 0, 15,
    28, 12, 0, 15,
    28, 20, 8, 13,
    28, 22, 8, 15,
    0, 22, 8, 15,
    0, 20, 8, 13,
    0, 12, 0, -1,
    0, 22, 8, 0,
    28, 22, 8, -1,
    23, 17, 5, 0,
    23, 0, 5, -1,
    13, 13, 1, 0,
    13, 0, 1, -1,
    16, 0, 7, 0,
    16, 19, 7, -1,
    0, 20, 8, 0,
    28, 20, 8, -1,
    19, 17, 5, 0,
    19, 0, 5, -1

```

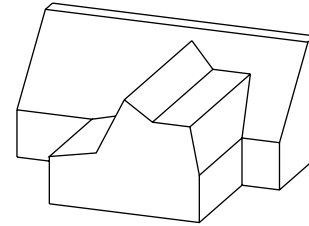

MASS{2}

```

MASS{2} top_material, bottom_material, side_material,
         n, m, mask, h,
         x1, y1, z1, s1,
         ...
         xn, yn, zn, sn,
         xn+1, yn+1, zn+1, sn+1,
         ...
         xn+m, yn+m, zn+m, sn+m

```

Extension of the MASS command with an additional mask bit and the possibility of hiding all top edges of the mass.

mask :

$mask = j_1 + 4*j_3 + 16*j_5 + 32*j_6 + 64*j_7 + 128*j_8 + 256*j_9 + 512*j_{10}$, where each j can be 0 or 1.

- j_1 : base surface is present,
- j_3 : side surfaces are present,
- j_5 : base and side edges are visible,
- j_6 : top edges are visible,
- j_7 : top edges are visible, top surface is not smooth,
- j_8 : all ridges will be sharp, but the surface is smooth.
- j_9 : edges participate in line elimination.
- j_{10} : all top edges will be hidden.

Example:

```
PEN 1
mat = IND (MATERIAL, "Metal-Aluminium")
FOR i=1 TO 2 STEP 1
  MASS{2} mat, mat, mat,
    5, 0, 1+4+16+32+64+256, -1,
    0, 0, 0, 15,
    2, 0, 0, 15,
    2, 2, 0, 15,
    0, 2, 0, 15,
    0, 0, 0, -1
  BODY -1
  ADDX 2
NEXT i
```

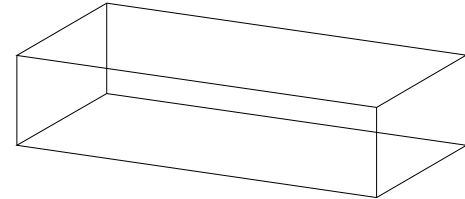

POLYROOF

```
POLYROOF defaultMat, k, m, n,
  offset, thickness, applyContourInsidePivot,
  z 1, ..., z k,
  pivotX_1, pivotY_1, pivotMask_1,
  roofAngle_11, gableOverhang_11, topMat_11, bottomMat_11,
  ...
  roofAngle_1k, gableOverhang_1k, topMat_1k, bottomMat_1k,
  ...
  pivotX_m, pivotY_m, pivotMask_m,
  roofAngle_m1, gableOverhang_m1, topMat_m1, bottomMat_m1,
  ...
  roofAngle_mk, gableOverhang_mk, topMat_mk, bottomMat_mk,
  contourX_1, contourY_1, contourMask_1, edgeTrim_1, edgeAngle_1, edgeMat_1,
  ...
  contourX_n, contourY_n, contourMask_n, edgeTrim_n, edgeAngle_n, edgeMat_n
```

The command creates a possibly multi-level roof in which the geometry is controlled by multiple parameters, most importantly the roof angles and two polygons: a pivot polygon and a contour polygon. At the pivot polygon, the roof is slanted at the roof angle. It ascends until it either

reaches the height of the next level or until it is eliminated by its sides encountering one another. It also descends downwards, until it reaches the contour polygon, which cuts off parts of the roof outside of it. The contour polygon can also be used to cut holes in the roof.

defaultMat: the numeric index of the "inner" material of the roof. This material becomes visible at gables and at cut surfaces, e.g., if the roof is cut by a plane.

k: the number of levels.

m: the number of pivot polygon vertices.

n: the number of contour polygon vertices.

offset: an offset for the thickness of the roof.

thickness: the thickness of the roof.

applyContourInsidePivot: if set to 0, the outer contour polygon is only applied below the pivot polygon plane. If set to 1, the outer contour polygon is applied both above and below the pivot polygon plane. The 0 setting may be used to prevent the contour polygon from cutting off gables that lean outwards.

z_i: the Z coordinate of a level.

pivotX_i, pivotY_i: coordinates of the pivot polygon vertices.

pivotMask_i:

0: marks a normal vertex,

-1: marks the end of the current pivot subpolygon (outer contour or hole). Data for such a vertex must be a copy of the data for the first vertex of the subpolygon. A polygon must always be closed with a mask value of -1, even if there are no holes inside it.

roofAngle_i: angle of slant for a pivot edge on a given level. If the angle ≥ 90 , that part of the roof becomes a gable.

gableOverhang_i: at the sides of a gable, the roof can extend over a lower level of itself. The amount of this can be controlled by this parameter, which has effect only on gables (roofAngle ≥ 90) that are at least on the second level of the roof.

topMat_i, bottomMat_i: the numeric index of the materials for the top and bottom of the roof.

contourX_i, contourY_i: coordinates of the contour polygon vertices.

contourMask_i:

0: marks a normal vertex,

-1: marks the end of the current contour subpolygon (outer contour or hole). Data for such a vertex must be a copy of the data for the first vertex of the subpolygon. A polygon must always be closed with a mask value of -1, even if there are no holes inside it.

edgeTrim_i: specifies the way the edge is trimmed by the contour polygon. Possible values are:

0: Vertical,

- 1: Perpendicular to roof plane,
- 2: Horizontal,
- 3: Custom angle to roof plane.

edgeAngle_i: the custom angle of the edge to the roof plane. It has effect only if edgeTrim is set to 3 (custom angle to roof plane).

edgeMat_i: numeric index of the material at the edge the roof, where the contour cuts it

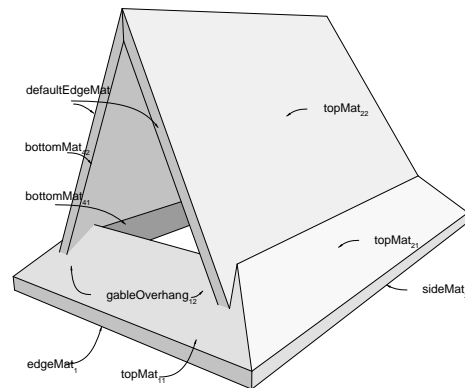

Figure 1: Materials

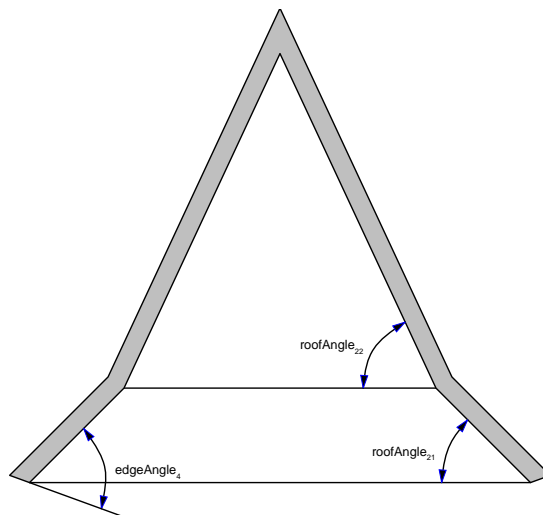

Figure 2: Angles

Example:

```
POLYROOF "Paint-01",
  2, 5, 5,
  0, 0.2, 0,
  ! Start of z values
  2.7,
  3.2,
  ! Start of pivot polygon
  2, 8, 0,
  45, 0, ind(material, "Paint-01"), ind(material, "Paint-01"),
  90, 0.5, ind(material, "Paint-01"), ind(material, "Paint-01"),
  2, 3, 0,
  45, 0, ind(material, "Paint-01"), ind(material, "Paint-01"),
  65, 0, ind(material, "Paint-01"), ind(material, "Paint-01"),
  10, 3, 0,
  45, 0, ind(material, "Paint-01"), ind(material, "Paint-01"),
  65, 0, ind(material, "Paint-01"), ind(material, "Paint-01"),
  10, 8, 0,
  45, 0, ind(material, "Paint-01"), ind(material, "Paint-01"),
  65, 0, ind(material, "Paint-01"), ind(material, "Paint-01"),
  2, 8, -1,
  45, 0, ind(material, "Paint-01"), ind(material, "Paint-01"),
  90, 0.5, ind(material, "Paint-01"), ind(material, "Paint-01"),
  ! Start of contour polygon
  1.5, 8.5, 0, 0, 0, ind(material, "Paint-01"),
  1.5, 2.5, 0, 0, 0, ind(material, "Paint-01"),
  10.5, 2.5, 0, 0, 0, ind(material, "Paint-01"),
  10.5, 8.5, 0, 0, 0, ind(material, "Paint-01"),
  1.5, 8.5, -1, 0, 0, ind(material, "Paint-01")
```

Output: see Figure 1

POLYROOF{2}

```

POLYROOF{2} defaultMat, k, m, n,
  offset, thickness, totalThickness, applyContourInsidePivot,
  z_1, ..., z_k,
  pivotX_1, pivotY_1, pivotMask_1,
  roofAngle_11, gableOverhang_11, topMat_11, bottomMat_11,
  ...
  roofAngle_1k, gableOverhang_1k, topMat_1k, bottomMat_1k,
  ...
  pivotX_m, pivotY_m, pivotMask_m,
  roofAngle_m1, gableOverhang_m1, topMat_m1, bottomMat_m1,
  ...
  roofAngle_mk, gableOverhang_mk, topMat_mk, bottomMat_mk,
  contourX_1, contourY_1, contourMask_1, edgeTrim_1, edgeAngle_1, edgeMat_1,
  ...
  contourX_n, contourY_n, contourMask_n, edgeTrim_n, edgeAngle_n, edgeMat_n

```

POLYROOF{2} is an extension of the POLYROOF command with the possibility of defining the total thickness of the roof. This parameter should be considered together with offset and thickness, when the generation of a slice of the roof is desirable. In this case the thickness and the offset should be set to the thickness of the slice and to the distance between the top planes of the slice and the complete roof respectively.

totalThickness: the total thickness of the roof.

POLYROOF{3}

```

POLYROOF{3} defaultMat, mask, k, m, n,
  offset, thickness, totalThickness, applyContourInsidePivot,
  z_1, ..., z_k,
  pivotX_1, pivotY_1, pivotMask_1,
  roofAngle_11, gableOverhang_11, topMat_11, bottomMat_11,
  ...
  roofAngle_1k, gableOverhang_1k, topMat_1k, bottomMat_1k,
  ...
  pivotX_m, pivotY_m, pivotMask_m,
  roofAngle_m1, gableOverhang_m1, topMat_m1, bottomMat_m1,
  ...
  roofAngle_mk, gableOverhang_mk, topMat_mk, bottomMat_mk,
  contourX_1, contourY_1, contourMask_1, edgeTrim_1, edgeAngle_1, edgeMat_1,
  ...
  contourX_n, contourY_n, contourMask_n, edgeTrim_n, edgeAngle_n, edgeMat_n

```

POLYROOF{3} is an extension of the POLYROOF{2} command with the possibility of controlling the global behavior of the generated roof.

mask: controls the global behavior of the generated roof.

$mask = j_1 + 2*j_2$, where each j can be 0 or 1.

j_1 : edges participate in line elimination.

j_2 : Make all edges invisible.

Example:

```
pen 1
mat = IND (MATERIAL, "Metal-Aluminium")
a = -0.4242640691048 : b = 4.424264068326
c = 6.424264068326
POLYROOF{3} mat,1, 2, 5, 5,
  0, 0.3, 0.3, 1, 0, 1,
  a, b, 0, 45, 0, mat, mat, 90, 0, mat, mat,
  a, a, 0, 45, 0, mat, mat, 90, 0, mat, mat,
  c, a, 0, 45, 0, mat, mat, 90, 0, mat, mat,
  c, b, 0, 45, 0, mat, mat, 90, 0, mat, mat,
  a, b, -1, 45, 0, mat, mat, 90, 0, mat, mat,
  -0.8, -0.8, 0, 2, 0, mat,
  6.8, -0.8, 0, 2, 0, mat,
  6.8, 4.8, 0, 2, 0, mat,
  -0.8, 4.8, 0, 2, 0, mat,
  -0.8, -0.8, -1, 2, 0, mat
```

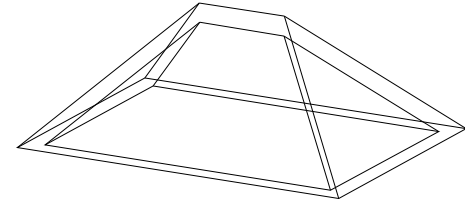

```
a = 0.1514718617904 : b = 3.848528136652
c = 5.848528136652 : q = 0.5757359305057
w = 5.424264067936 : e = 3.424264056692
POLYROOF{3} mat,1, 1, 5, 5,
  0, 0.3, 0.3, 1, 0.5757359312847,
  a, b, 0, 45, 0, mat, mat,
  a, a, 0, 45, 0, mat, mat,
  c, a, 0, 45, 0, mat, mat,
  c, b, 0, 45, 0, mat, mat,
  a, b, -1, 45, 0, mat, mat,
  q, q, 0, 0, 0, mat,
  w, q, 0, 0, 0, mat,
  w, e, 0, 0, 0, mat,
  q, e, 0, 0, 0, mat,
  q, q, -1, 0, 0, mat
```

POLYROOF{4}

```
POLYROOF{4} defaultMat, mask, k, m, n,
  offset, thickness, totalThickness, applyContourInsidePivot,
  z_1, ..., z_k,
  pivotX_1, pivotY_1, pivotMask_1,
  roofAngle_11, gableOverhang_11, topMat_11, bottomMat_11,
  ...
  roofAngle_1k, gableOverhang_1k, topMat_1k, bottomMat_1k,
  ...
  pivotX_m, pivotY_m, pivotMask_m,
  roofAngle_m1, gableOverhang_m1, topMat_m1, bottomMat_m1,
  ...
  roofAngle_mk, gableOverhang_mk, topMat_mk, bottomMat_mk,
  contourX_1, contourY_1, contourMask_1, edgeTrim_1, edgeAngle_1, edgeMat_1,
  ...
  contourX_n, contourY_n, contourMask_n, edgeTrim_n, edgeAngle_n, edgeMat_n
```

POLYROOF{4} is an extension of the POLYROOF{3} command with the possibility of using inline material definition, that means materials defined in GDL script locally also can be used next to materials defined in global material definitions.

EXTRUDED SHELL

```
EXTRUDED SHELL topMat, bottomMat, sideMat_1, sideMat_2, sideMat_3, sideMat_4,
  defaultMat,
  n, offset, thickness, flipped, trimmingBody,
  x_tb, y_tb, x_te, y_te, topz, tangle,
  x_bb, y_bb, x_be, y_be, bottomz, bangle,
  preThickenTran_11, preThickenTran_12, preThickenTran_13, preThickenTran_14,
  preThickenTran_21, preThickenTran_22, preThickenTran_23, preThickenTran_24,
  preThickenTran_31, preThickenTran_32, preThickenTran_33, preThickenTran_34,
  x_1, y_1, s_1,
  ...
  x_n, y_n, s_n
```

Surface created by first extruding a polyline, then adding thickness to it.

topMat, bottomMat, sideMat_1, sideMat_2, sideMat_3, sideMat_4: Materials on the top, bottom and four sides of the object.

defaultMat: the numeric index of the "inner" material of the object. This material becomes visible at cut surfaces, e.g., if the object is cut by a plane.

n: number of profile base polyline vertices.

offset: an offset for the thickness of the shell. Cannot be negative.

thickness: the thickness of the shell.

flipped:

- 1: if the shell should be flipped,
- 0: otherwise.

trimmingBody:

- 1: if the shell is to be closed for trimming purposes,
- 0: otherwise.

x_tb, y_tb, x_te, y_te, topz, tangle: Specify the top plane of the extrusion. The meaning of the parameters is the same as for the SPRISM_{2} command.

x_bb, y_bb, x_be, y_be, bottomz, bangle: Specify the bottom plane of the extrusion. The meaning of the parameters is the same as for the SPRISM_{2} command.

preThickenTran_i: a transformation executed before thickening. See the XFORM command for the meaning of parameters.

x_i, y_i, s_i: X and Y coordinates and status values for the base profile polyline. See the EXTRUDE command for details. The visibility of the sides cannot be controlled with the status.

EXTRUDED SHELL{2}

```
EXTRUDED SHELL{2} topMat, bottomMat, sideMat_1, sideMat_2, sideMat_3, sideMat_4,
    defaultMat,
    n, status, offset, thickness, flipped, trimmingBody,
    x_tb, y_tb, x_te, y_te, topz, tangle,
    x_bb, y_bb, x_be, y_be, bottomz, bangle,
    preThickenTran_11, preThickenTran_12, preThickenTran_13, preThickenTran_14,
    preThickenTran_21, preThickenTran_22, preThickenTran_23, preThickenTran_24,
    preThickenTran_31, preThickenTran_32, preThickenTran_33, preThickenTran_34,
    x_1, y_1, s_1,
    ...
    x_n, y_n, s_n
```

EXTRUDED SHELL{2} is an extension of the EXTRUDED SHELL command with the possibility of hiding edges between original and thickened surface.

status: Status bits:

status = j_1 , where each j can be 0 or 1.

j_1 : Make edges invisible between original and thickened surface.

Example:

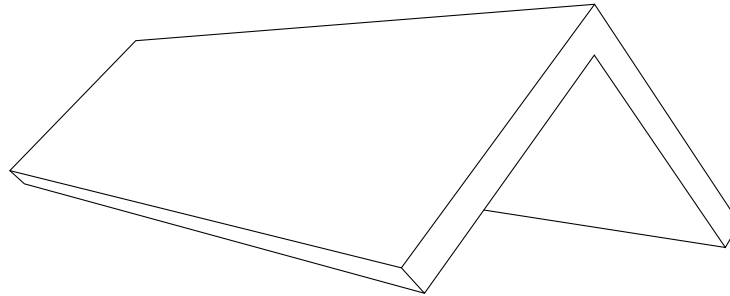

```

EXTRUDESHELL "Paint-02", "Surf-Stucco Yellow",
  "Surf-Stucco Yellow", "Surf-Stucco Yellow", "Surf-Stucco Yellow",
  "Surf-Stucco Yellow", "Surf-Stucco Yellow",
  3, 0.00, 0.30, 0, 0,
  ! 2 slant planes
  0.00, 0.00, 0.00, 1.00, 0.00, 0.00,
  0.00, 0.00, 0.00, 1.00, -10.00, 0.00,
  ! transformation matrix
  0.00, 0.00, 1.00, 0.00,
  1.00, 0.00, 0.00, 0.00,
  0.00, 1.00, 0.00, 0.00,
  ! profile polyline
  2.00, 0.00, 15,
  0.00, 2.00, 15,
  -2.00, 0.00, 15

```

EXTRUDESHELL{3}

```

EXTRUDESHELL{3} topMat, bottomMat, sideMat_1, sideMat_2, sideMat_3, sideMat_4,
  defaultMat,
  n, status, offset, thickness, flipped, trimmingBody,
  x_tb, y_tb, x_te, y_te, topz, tangle,
  x_bb, y_bb, x_be, y_be, bottomz, bangle,
  preThickenTran_11, preThickenTran_12, preThickenTran_13, preThickenTran_14,
  preThickenTran_21, preThickenTran_22, preThickenTran_23, preThickenTran_24,
  preThickenTran_31, preThickenTran_32, preThickenTran_33, preThickenTran_34,
  x_1, y_1, s_1,
  ...
  x_n, y_n, s_n

```

EXTRUDESHELL{3} is an extension of the EXTRUDESHELL{2} command with the possibility of using inline material definition, that means materials defined in GDL script locally also can be used next to materials defined in global material definitions.

REVOLVEDSHELL

```

REVOLVEDSHELL topMat, bottomMat, sideMat_1, sideMat_2, sideMat_3, sideMat_4,
  defaultMat,
  n, offset, thickness, flipped, trimmingBody, alphaOffset, alpha,
  preThickenTran_11, preThickenTran_12, preThickenTran_13, preThickenTran_14,
  preThickenTran_21, preThickenTran_22, preThickenTran_23, preThickenTran_24,
  preThickenTran_31, preThickenTran_32, preThickenTran_33, preThickenTran_34,
  x_1, y_1, s_1,
  ...
  x_n, y_n, s_n

```

Surface created by rotating a polyline defined in the x-y plane around the x axis, then adding thickness to it.

topMat, bottomMat, sideMat_1, sideMat_2, sideMat_3, sideMat_4: Materials on the top, bottom and four sides of the object.

defaultMat: the numeric index of the "inner" material of the object. This material becomes visible at cut surfaces, e.g, if the object is cut by a plane.

n: number of profile base polyline vertices.

offset: an offset for the thickness of the shell. Cannot be negative.

thickness: the thickness of the shell.

flipped:

1: if the shell should be flipped,
0: otherwise.

trimmingBody:

1: if the shell is to be closed for trimming purposes,
0: otherwise.

alphaOffset: the sweep start angle.

alpha: the sweep angle length in degrees, may be negative.

preThickenTran_i: a transformation executed before thickening. See the XFORM command for the meaning of parameters.

x_i, y_i, s_i: X and Y coordinates and status values for the base profile polyline. See the EXTRUDE command for details. The visibility of the sides cannot be controlled with the status.

REVOLVEDSHELL{2}

```

REVOLVEDSHELL{2} topMat, bottomMat, sideMat_1, sideMat_2, sideMat_3, sideMat_4,
  defaultMat,
  n, status, offset, thickness, flipped, trimmingBody, alphaOffset, alpha,
  preThickenTran_11, preThickenTran_12, preThickenTran_13, preThickenTran_14,
  preThickenTran_21, preThickenTran_22, preThickenTran_23, preThickenTran_24,
  preThickenTran_31, preThickenTran_32, preThickenTran_33, preThickenTran_34,
  x_1, y_1, s_1,
  ...
  x_n, y_n, s_n

```

REVOLVEDSHELL{2} is an extension of the REVOLVEDSHELL command with the possibility of hiding edges of surfaces, and edges between original and thickened surface.

status: Status bits:

$status = j_1 + 2*j_2$, where each j can be 0 or 1.

j_1 : Make edges invisible between original and thickened surface.

j_2 : Make edges invisible on surfaces.

Example:

```
REVOLVEDSHELL "Paint-02", "Surf-Stucco Yellow",  
  "Surf-Stucco Yellow", "Surf-Stucco Yellow", "Surf-Stucco Yellow",  
  "Surf-Stucco Yellow", "Surf-Stucco Yellow",  
  2, 0.00, 0.30, 0, 0, 0.00, 270.00,  
  ! transformation matrix  
  0.00, 0.00, -1.00, 0.00,  
  0.00, 1.00, 0.00, 0.00,  
  1.00, 0.00, 0.00, 0.00,  
  ! profile polyline  
  4.00, 0.00, 2,  
  0.00, 4.00, 2
```

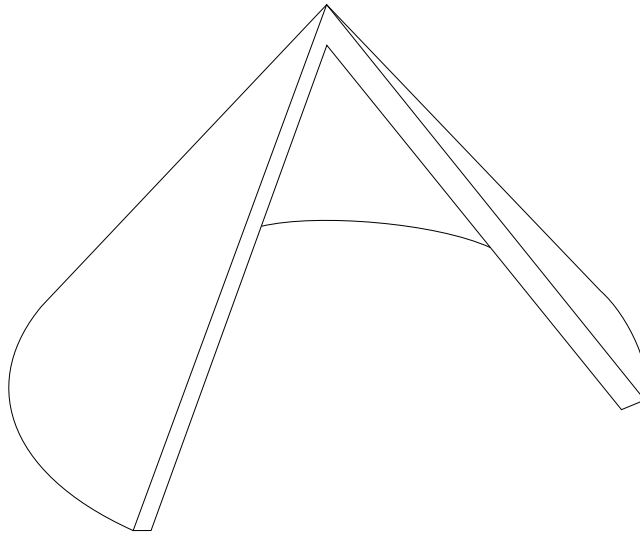

REVOLVEDSHELL{3}

```

REVOLVEDSHELL{3} topMat, bottomMat, sideMat_1, sideMat_2, sideMat_3, sideMat_4,
    defaultMat,
    n, status, offset, thickness, flipped, trimmingBody, alphaOffset, alpha,
    preThickenTran_11, preThickenTran_12, preThickenTran_13, preThickenTran_14,
    preThickenTran_21, preThickenTran_22, preThickenTran_23, preThickenTran_24,
    preThickenTran_31, preThickenTran_32, preThickenTran_33, preThickenTran_34,
    x_1, y_1, s_1,
    ...
    x_n, y_n, s_n

```

REVOLVEDSHELL{3} is an extension of the REVOLVEDSHELL{2} command with the possibility of using inline material definition, that means materials defined in GDL script locally also can be used next to materials defined in global material definitions.

REVOLVEDSHELLANGULAR

```

REVOLVEDSHELLANGULAR topMat, bottomMat,
    sideMat_1, sideMat_2, sideMat_3, sideMat_4, defaultMat,
    n, offset, thickness, flipped, trimmingBody, alphaOffset, alpha,
    segmentationType, nOfSegments,
    preThickenTran_11, preThickenTran_12, preThickenTran_13,
    preThickenTran_14,
    preThickenTran_21, preThickenTran_22, preThickenTran_23,
    preThickenTran_24,
    preThickenTran_31, preThickenTran_32, preThickenTran_33,
    preThickenTran_34,
    x_1, y_1, s_1,
    ...
    x_n, y_n, s_n

```

An angular variant of the REVOLVEDSHELL command. Parameters are the same with the addition of the following extra parameters:

segmentationType: Must be either 1 or 2.

- 1: means that 360 degrees of revolution is split into nOfSegments segments,
- 2: means that the actual revolution angle (given by the alpha parameter) is split into nOfSegments segments.

nOfSegments: Number of segments, see segmentationType parameter above.

REVOLVEDSHELLANGULAR{2}

```

REVOLVEDSHELLANGULAR{2} topMat, bottomMat,
    sideMat_1, sideMat_2, sideMat_3, sideMat_4, defaultMat,
    n, status, offset, thickness, flipped, trimmingBody, alphaOffset, alpha,
    segmentationType, nOfSegments,
    preThickenTran_11, preThickenTran_12, preThickenTran_13,
    preThickenTran_14,
    preThickenTran_21, preThickenTran_22, preThickenTran_23,
    preThickenTran_24,
    preThickenTran_31, preThickenTran_32, preThickenTran_33,
    preThickenTran_34,
    x_1, y_1, s_1,
    ...
    x_n, y_n, s_n

```

REVOLVEDSHELLANGULAR{2} is an extension of the REVOLVEDSHELLANGULAR command with the possibility of hiding edges of surfaces, and edges between original and thickened surface.

status: Status bits:

status = $j_1 + 2*j_2$, where each j can be 0 or 1.

j_1 : Make edges invisible between original and thickened surface.

j_2 : Make edges invisible on surfaces.

REVOLVEDSHELLANGULAR{3}

```

REVOLVEDSHELLANGULAR{3} topMat, bottomMat,
    sideMat_1, sideMat_2, sideMat_3, sideMat_4, defaultMat,
    n, status, offset, thickness, flipped, trimmingBody, alphaOffset, alpha,
    segmentationType, nOfSegments,
    preThickenTran_11, preThickenTran_12, preThickenTran_13,
    preThickenTran_14,
    preThickenTran_21, preThickenTran_22, preThickenTran_23,
    preThickenTran_24,
    preThickenTran_31, preThickenTran_32, preThickenTran_33,
    preThickenTran_34,
    x_1, y_1, s_1,
    ...
    x_n, y_n, s_n

```

REVOLVEDSHELLANGULAR{3} is an extension of the REVOLVEDSHELLANGULAR{2} command with the possibility of using inline material definition, that means materials defined in GDL script locally also can be used next to materials defined in global material definitions.

RULEDSHELL

```
RULEDSHELL topMat, bottomMat,
             sideMat_1, sideMat_2, sideMat_3, sideMat_4, defaultMat,
             n, m, g,
             offset, thickness, flipped, trimmingBody,
             preThickenTran_11, preThickenTran_12, preThickenTran_13, preThickenTran_14,
             preThickenTran_21, preThickenTran_22, preThickenTran_23, preThickenTran_24,
             preThickenTran_31, preThickenTran_32, preThickenTran_33, preThickenTran_34,
             firstpolyX_1, firstpolyY_1, firstpolyS_1,
             ...
             firstpolyX_n, firstpolyY_n, firstpolyS_n,
             secondpolyX_1, secondpolyY_1, secondpolyS_1,
             ...
             secondpolyX_m, secondpolyY_m, secondpolyS_m,
             profile2Tran_11, profile2Tran_12, profile2Tran_13, profile2Tran_14
             profile2Tran_21, profile2Tran_22, profile2Tran_23, profile2Tran_24
             profile2Tran_31, profile2Tran_32, profile2Tran_33, profile2Tran_34
             generatrixFirstIndex_1, generatrixSecondIndex_1,
             ...
             generatrixFirstIndex_g, generatrixSecondIndex_g
```

Surface created by connecting two polylines.

topMat, bottomMat, sideMat_1, sideMat_2, sideMat_3, sideMat_4: Materials on the top, bottom and four sides of the object.

defaultMat: the numeric index of the "inner" material of the object. This material becomes visible at cut surfaces, e.g, if the object is cut by a plane.

n: number of vertices for first profile base polyline.

m: number of vertices for second profile base polyline.

g: number of generatrices.

offset: an offset for the thickness of the shell. Cannot be negative.

thickness: thickness of the shell.

flipped:

- 1: if the shell should be flipped,
- 0: otherwise

preThickenTran: a transformation executed before thickening. See the XFORM command for the meaning of parameters.

trimmingBody:

- 1: if the shell is to be closed for trimming purposes,
- 0: otherwise

firstpolyX, firstpolyY, firstpolyS: X and Y coordinates and status values for the first base profile polyline. See the REVOLVE command for details.

secondpolyX, secondpolyY, secondpolyS: X and Y coordinates and status values for the second base profile polyline. See the REVOLVE command for details.

profile2Tran: a transformation executed on the second profile. Use this transformation to position the second profile relative to the first one. See the XFORM command for the meaning of parameters.

generatrixFirstIndex, generatrixSecondIndex: pairs of indexes, one from the first polyline and one from the second polyline. The vertexes with the given indexes will be connected with a line.

RULEDSHELL{2}

```

RULEDSHELL{2} topMat, bottomMat,
    sideMat_1, sideMat_2, sideMat_3, sideMat_4, defaultMat,
    n, m, g, status,
    offset, thickness, flipped, trimmingBody,
    preThickenTran_11, preThickenTran_12, preThickenTran_13, preThickenTran_14,
    preThickenTran_21, preThickenTran_22, preThickenTran_23, preThickenTran_24,
    preThickenTran_31, preThickenTran_32, preThickenTran_33, preThickenTran_34,
    firstpolyX_1, firstpolyY_1, firstpolyS_1,
    ...
    firstpolyX_n, firstpolyY_n, firstpolyS_n,
    secondpolyX_1, secondpolyY_1, secondpolyS_1,
    ...
    secondpolyX_m, secondpolyY_m, secondpolyS_m,
    profile2Tran_11, profile2Tran_12, profile2Tran_13, profile2Tran_14
    profile2Tran_21, profile2Tran_22, profile2Tran_23, profile2Tran_24
    profile2Tran_31, profile2Tran_32, profile2Tran_33, profile2Tran_34
    generatrixFirstIndex_1, generatrixSecondIndex_1,
    ...
    generatrixFirstIndex_g, generatrixSecondIndex_g

```

RULEDSHELL{2} is an extension of the **RULEDSHELL** command with the possibility of hiding edges of surfaces, and edges between original and thickened surface.

status: Status bits:

$status = j_1 + 2*j_2$, where each j can be 0 or 1.

j_1 : Make edges invisible between original and thickened surface.

j_2 : Make edges invisible on surfaces.

Example:

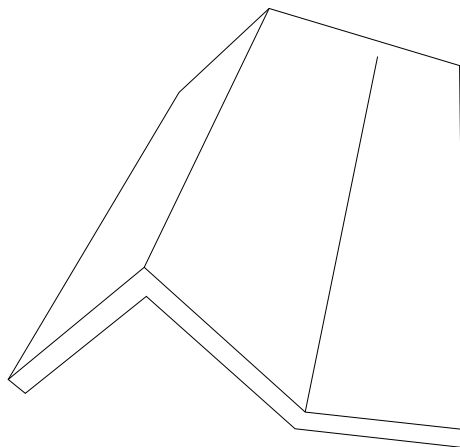

```
RULEDSHELL "Paint-14", "Paint-14",
  "Paint-14", "Paint-14", "Paint-14", "Paint-14", "Paint-14",
  4,      3,      3,
  0.00,  0.30,  0, 0,
  ! transformation matrix
  1.00,  0.00,  0.00,  0.00,
  0.00,  0.00, -1.00,  0.00,
  0.00,  1.00,  0.00,  0.00,
  ! profile 1 polyline
  0.00,  0.00,  2,
  2.00,  2.00,  2,
  4.00,  0.00,  2,
  6.00,  0.00,  2,
  ! profile 2 polyline
  0.00,  0.00,  2,
  2.00,  2.00,  2,
  6.00,  1.00,  2,
  ! transformation matrix
  1.00,  0.00,  0.00,  0.00,
  0.00,  1.00,  0.00,  0.00,
  0.00,  0.00,  1.00, -10.00,
  ! generatrices
  1,      1,
  2,      2,
  4,      3
```

RULEDSHELL{3}

```
RULEDSHELL{3} topMat, bottomMat,
  sideMat_1, sideMat_2, sideMat_3, sideMat_4, defaultMat,
  n, m, g, status,
  offset, thickness, flipped, trimmingBody,
  preThickenTran_11, preThickenTran_12, preThickenTran_13, preThickenTran_14,
  preThickenTran_21, preThickenTran_22, preThickenTran_23, preThickenTran_24,
  preThickenTran_31, preThickenTran_32, preThickenTran_33, preThickenTran_34,
  firstpolyX_1, firstpolyY_1, firstpolyS_1,
  ...
  firstpolyX_n, firstpolyY_n, firstpolyS_n,
  secondpolyX_1, secondpolyY_1, secondpolyS_1,
  ...
  secondpolyX_m, secondpolyY_m, secondpolyS_m,
  profile2Tran_11, profile2Tran_12, profile2Tran_13, profile2Tran_14
  profile2Tran_21, profile2Tran_22, profile2Tran_23, profile2Tran_24
  profile2Tran_31, profile2Tran_32, profile2Tran_33, profile2Tran_34
  generatrixFirstIndex_1, generatrixSecondIndex_1,
  ...
  generatrixFirstIndex_g, generatrixSecondIndex_g
```

RULEDSHELL{3} is an extension of the RULEDSHELL{2} command with the possibility of using inline material definition, that means materials defined in GDL script locally also can be used next to materials defined in global material definitions.

ELEMENTS FOR VISUALIZATION

LIGHT

```
LIGHT red, green, blue, shadow,
  radius, alpha, beta, angle_falloff,
  distance1, distance2,
  distance_falloff [[,] ADDITIONAL_DATA name1 = value1,
  name2 = value2, ...]
```

A light source radiates [red, green, blue] colored light from the local origin along the local x axis. The light is projected parallel to the x axis from a point or circle source. It has its maximum intensity within the alpha-angle frustum of a cone and falls to zero at the beta-angle frustum of a cone. This falloff is controlled by the angle_falloff parameter. (Zero gives the light a sharp edge, higher values mean that the transition is smoother.) The effect of the light is limited along the axis by the distance1 and distance2 clipping values. The distance_falloff parameter controls the decrease in intensity depending on the distance. (Zero value means a constant intensity; bigger values are used for stronger falloff.)

GDL transformations affect only the starting point and the direction of the light.

shadow: controls the light's shadow casting.

- 0: light casts no shadows,
- 1: light casts shadows.

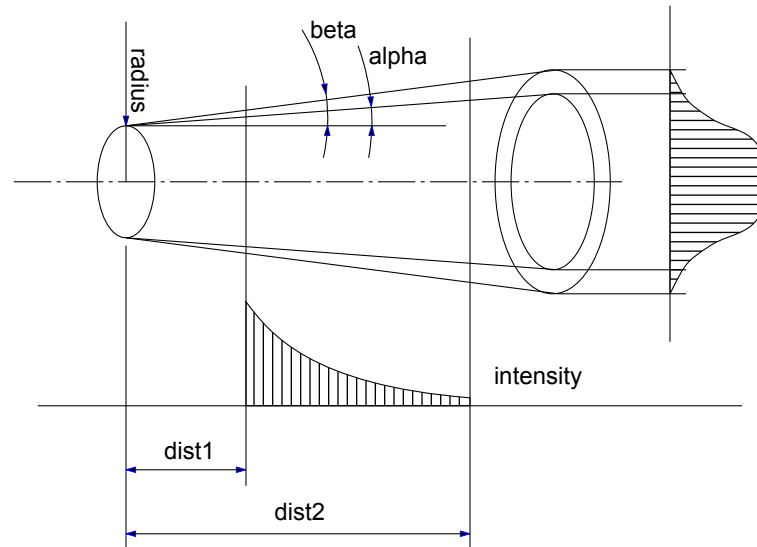

Restriction of parameters:

$$\alpha \leq \beta \leq 80^\circ$$

The following parameter combinations have special meanings:

$\text{radius} = 0, \alpha = 0, \beta = 0$: A point light, it radiates light in every direction and does not cast any shadows. The shadow and angle_falloff parameters are ignored, the values shadow = 0, angle_falloff = 0 are supposed.

$\text{radius} > 0, \alpha = 0, \beta = 0$: A directional light with parallel beams.

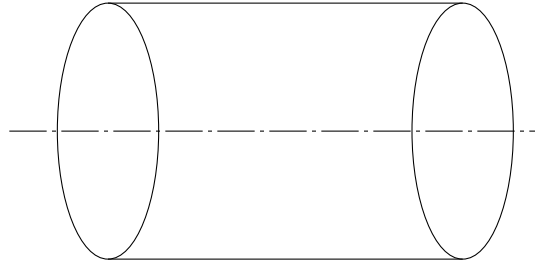

$r = 0$, $\alpha > 0$, $\beta > 0$: A directional light with conic beams.

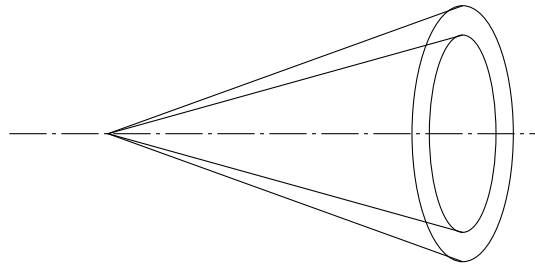

$r > 0$, $\alpha = 0$, $\beta > 0$: A directional light with parallel beam and conic falloff.

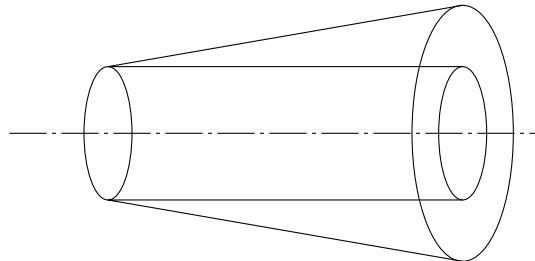

Light definitions can contain optional additional data definitions after the `ADDITIONAL_DATA` keyword. Additional data has a name (`namei`) and a value (`valuei`), which can be an expression of any type, even an array. If a string parameter name ends with the substring `"_file"`, its value is considered to be a file name and will be included in the archive project.

Different meanings of additional data can be defined and used by the executing application.

Example 1:

```
LIGHT 1.0,0.2,0.3,    ! RGB
      1,              ! shadow on
      1.0,            ! radius
      45.0, 60.0,     ! angle1, angle2
      0.3,             ! angle_falloff
      1.0, 10.0,      ! distance1, distance2
      0.2              ! distance_falloff
```

Example 2:

The library part dialog box for lights in ARCHICAD:

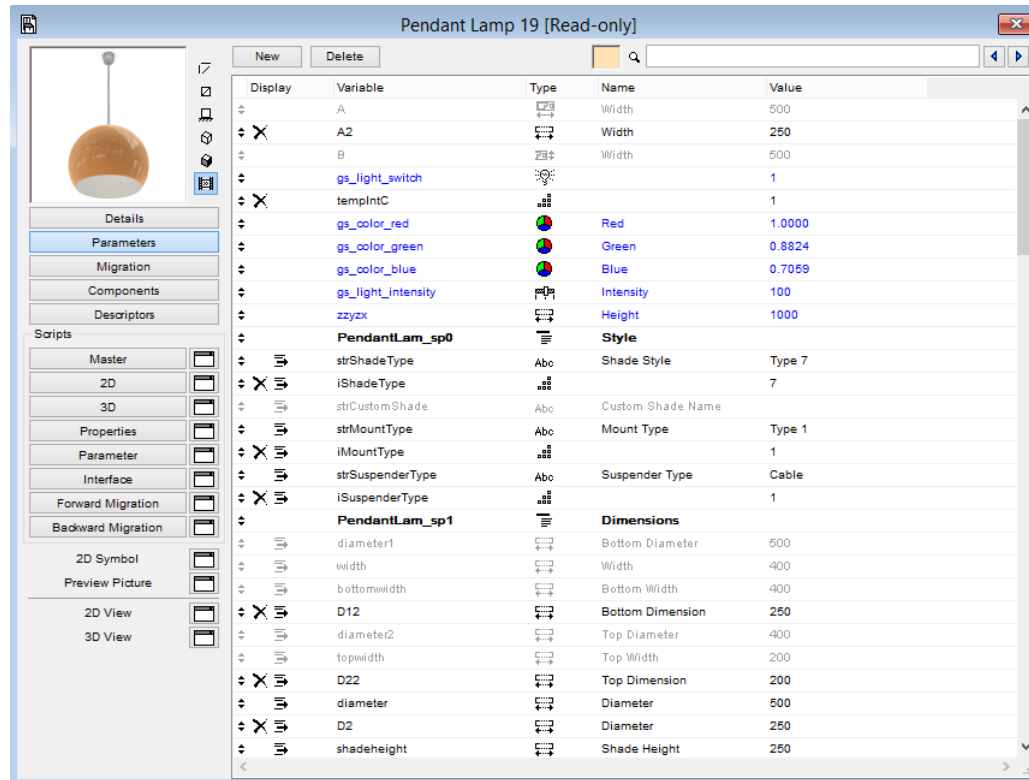

Part of the corresponding GDL script:

```

if gs_light_switch > 0 then
  LIGHT gs_light_intensity/100*gs_color_red, \
  gs_light_intensity/100*gs_color_green, \
  gs_light_intensity/100*gs_color_blue, ! RGB
  ...
endif

```

PICTURE

PICTURE expression, a, b, mask

A picture element for photorendering.

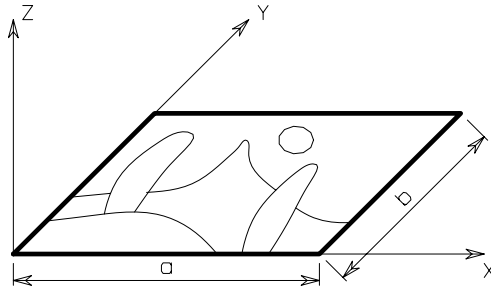

A string type expression means a file name, a numeric expression or the index of a picture stored in the library part. A 0 index is a special value that refers to the preview picture of the library part. Other pictures can only be stored in library parts when saving the project or selected elements containing pictures as GDL Objects.

Indexed picture reference cannot be used in the MASTER_GDL script when attributes are merged into the current attribute set. The image is fitted on a rectangle treated as a RECT in any other 3D projection method.

mask: alpha + distortion

alpha: alpha channel control.

- 0: do not use alpha channel; picture is a rectangle,
- 1: use alpha channel; parts of the picture may be transparent.

distortion: distortion control.

- 0: fit the picture into the given rectangle,
- 2: fit the picture in the middle of the rectangle using the natural aspect ratio of the picture,
- 4: fill the rectangle with the picture in a central position using natural aspect ratio of the picture.

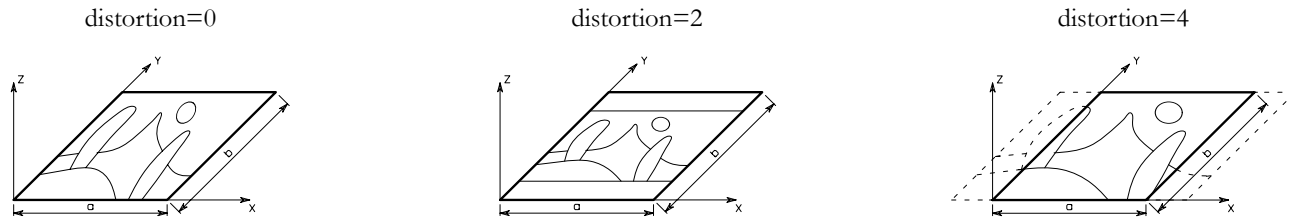

3D TEXT ELEMENTS

TEXT

TEXT *d*, 0, *expression*

A 3D representation of the value of a string or numeric type expression in the current style.

See the [SET] STYLE command and the DEFINE STYLE command.

d: thickness of the characters in meters.

In the current version of GDL, the second parameter is always zero.

Note: For compatibility with the 2D GDL script, character heights are always interpreted in millimeters in DEFINE STYLE statements.

Example 1:

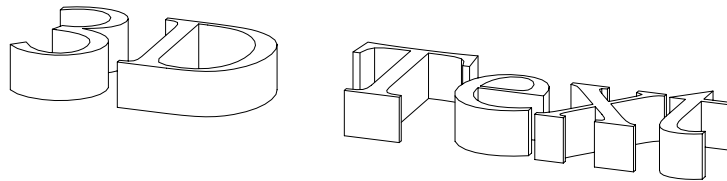

```
DEFINE STYLE "aa" "New York", 3, 7, 0
SET STYLE "aa"
TEXT 0.005, 0, "3D Text"
```

Example 2:

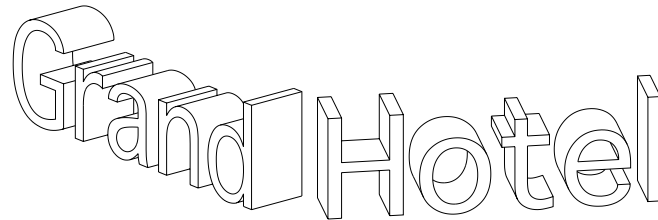

```
name = "Grand"
ROTX 90
ROTY -30
TEXT 0.003, 0, name
ADDX STW (name)/1000
ROTY 60
TEXT 0.003, 0, "Hotel"
```

RICHTEXT

RICHTEXT *x*, *y*,
 height, 0, *textblock_name*

A 3D representation of a previously defined TEXTBLOCK. For more details, *see the TEXTBLOCK command.*

x, **y**: X-Y coordinates of the richtext location.

height: thickness of the characters in meters.

textblock_name: the name of a previously defined TEXTBLOCK.

In the current version of GDL, the 4th parameter is always zero.

PRIMITIVE ELEMENTS

The primitives of the 3D data structure are VERT, VECT, EDGE, PGON and BODY. The bodies are represented by their surfaces and the connections between them. The information to execute a 3D cutaway comes from the connection information.

Indexing starts with 1, and a BASE statement or any new body (implicit BASE statement) resets indices to 1. For each edge, the indices of the adjacent polygons (maximum 2) are stored. Edges' orientations are defined by the two vertices determined first and second.

Polygons are lists of edges with an orientation including the indices of the edges. These numbers can have a negative prefix. This means that the given edge is used in the opposite direction. Polygons can include holes. In the list of edges, a zero index indicates a new hole. Holes must

not include other holes. One edge may belong to 0 to 2 polygons. In the case of closed bodies, the polygon's orientation is correct if the edge has different prefixes in the edge list of the two polygons.

The normal vectors of the polygons are stored separately. In the case of closed bodies, they point from the inside to the outside of the body. The orientation of the edge list is counterclockwise (mathematical positive), if you are looking at it from the outside. The orientation of the holes is opposite to that of the parent polygon. Normal vectors of an open body must point to the same side of the body.

To determine the inside and outside of bodies they must be closed. A simple definition for a closed body is the following: each edge has exactly two adjacent polygons.

The efficiency of the cutting, hidden line removal or rendering algorithms is lower for open bodies. Each compound three-dimensional element with regular parameters is a closed body in the internal 3D data structure.

Contour line searching is based on the status bits of edges and on their adjacent polygons. This is automatically set for compound curved elements but it is up to you to specify these bits correctly in the case of primitive elements.

In the case of a simplified definition (`vect = 0` or `status < 0` in a `PGON`) the primitives that are referred to by others must precede their reference. In this case, the recommended order is:

```
VERT (TEVE)
EDGE
(VECT)
PGON (PIPG)
COOR
BODY
```

Searching for adjacent polygons by the edges is done during the execution of the `BODY` command.

The numbering of `VERT`s, `EDGE`s, `VECT`s and `PGON`s is relative to the last (explicit or implicit) `BASE` statement.

Status values are used to store special information about primitives. Each single bit usually has an independent meaning in the status, but there are some exceptions.

Given values can be added together. Other bit combinations than the ones given below are strictly reserved for internal use. The default for each status is zero.

VERT

VERT *x*, *y*, *z*

A node in the x-y-z space, defined by three coordinates.

VERT{2}

VERT *x*, *y*, *z*, *hard*

Extension of the VERT command including a possibility to declare a node to be hard vertex. A hard vertex defines a break when rendering smooth surfaces.

x, y, z: coordinates of the node.

hard:

- 1: if the vertex should define a break when rendering smooth surfaces
- 0: otherwise

TEVE

TEVE x, y, z, u, v

Extension of the VERT command including a texture coordinate definition. Can be used instead of the VERT command if user-defined texture coordinates are required instead of the automatic texture wrapping (*see the COOR command*).

x, y, z: coordinates of a node.

u, v: texture coordinates of the node (u, v) coordinates for each vertex of the current body must be specified and each vertex should have only one texture coordinate. If VERT and TEVE statements are mixed inside a body definition, (u, v) coordinates are ineffective.

Note: The (u, v) texture coordinates are only effective in photorenderings, and not for vectorial fill mapping.

VECT

VECT x, y, z

Definition of the normal vector of a polygon by three coordinates. In case of a simplified definition (vect=0 in a PGON), these statements can be omitted.

EDGE

EDGE vert1, vert2, pgon1, pgon2, status

Definition of an edge.

vert1, vert2: index of the endpoints. The vert1 and vert2 indices must be different and referenced to previously defined VERTs.

pgon1, pgon2: indices of the neighboring polygons. Zero and negative values have special meanings:

- 0: terminal or standalone edge,
- < 0: possible neighbors will be searched for,

status: Status bits:

- status = $j_1 + 2*j_2 + 4*j_3 + 8*j_4 + 16*j_5 + 32*j_6 + 64*j_7 + 262144*j_{19}$, where each j can be 0 or 1.
- j_1 : invisible edge,

j_2 : edge of a curved surface.

Reserved status bits for future use:

j_3 : first edge of a curved surface (effective only when $j_2=1$),

j_4 : last edge of a curved surface (effective only when $j_2=1$),

j_5 : the edge is an arc segment,

j_6 : first segment of an arc (effective only when $j_4=1$),

j_7 : last segment of an arc (effective only when $j_4=1$),

j_{19} : render sharp edge between 2 curved polygons (effective only when $j_2=1$).

PGON

PGON n , *vect*, *status*, *edge1*, *edge2*, ..., *edgen*

Polygon definition.

n: number of edges in the edge list.

vect: index of the normal vector. It must refer to a previously defined VECT.

Note: If *vect* = 0, the program will calculate the normal vector during the analysis.

edge1, **edge2**, ..., **edgen**: these indices must refer to previously defined EDGEs. A zero value means the beginning or the end of a hole definition. A negative index changes the direction of the stored normal vector or edge to the opposite in the polygon. (The stored vector or edge does not change; other polygons can refer to it using the original orientation with a positive index.)

status: Status bits:

$status = j_1 + 2*j_2 + 16*j_5 + 32*j_6 + 64*j_7 + 4*j_3 + 8*j_4$, where each j can be 0 or 1.

j_1 : invisible polygon,

j_2 : polygon of a curved surface,

j_5 : concave polygon,

j_6 : polygon with hole(s),

j_7 : hole(s) are convex (effective only when $j_6=1$),

Reserved status bits for future use:

j_3 : first polygon of a curved surface (effective only when $j_2=1$),

j_4 : last polygon of a curved surface (effective only when $j_2=1$).

If the status value is negative, the engine will calculate the status of the polygon (like concave polygon or polygon with hole).

$n = 0$ is allowed for special purposes.

PGON{2}

PGON{2} *n*, *vect*, *status*, *wrap*, *edge_or_wrap1*, ..., *edge_or_wrapn*

The first three parameters are similar to the ones at the PGON command.

wrap: wrapping mode + projection type.

0: the global wrapping mode is applied,

> 0: the meaning is the same as it is in the COOR command.

edge_or_wrap1, ..., **edge_or_wrapn**: The number and meaning of these parameters are based on the wrap definition:

edge1, ..., *edgen*: if wrap is 0; in this case *edgen* means the same as at the PGON command, and globally defined texture mapping will be applied;

x1, *y1*, *z1*, *x2*, *y2*, *z2*, *x3*, *y3*, *z3*, *x4*, *y4*, *z4*, *edge1*, ..., *edgen*: if wrapping mode isn't 0 in wrap; in this case *x_i*, *y_i*, *z_i* coordinates defining the coordinate system of the texture mapping for the polygon;

edge1, *u1*, *v1*, ..., *edgen*, *un*, *vn*: if wrapping mode is 0 but projection type isn't 0 in wrap; in this case *u_i*, *v_i* texture space coordinates are the same as at the TEVE command; the mapping will affect the currently defined polygon only.

PGON{3}

PGON{3} *n*, *vect*, *status*, *wrap_method*, *wrap_flags*, *edge_or_wrap1*, ..., *edge_or_wrapn*

The parameters are similar to the the PGON{2} command, except wrap, which is split into two parameters *wrap_method* and *wrap_flags*. The meaning of these is the same as in the COOR{2} command.

PIPG

PIPG *expression*, *a*, *b*, *mask*, *n*, *vect*, *status*,
edge1, *edge2*, ..., *edgen*

Picture polygon definition. The first four parameters are the same as in the PICTURE command; the remaining ones are the same as in the PGON command.

COOR

COOR *wrap*, *vert1*, *vert2*, *vert3*, *vert4*

Deprecated. See the COOR{3} command.

Local coordinate system of a BODY for the fill and texture mapping.

wrap: wrapping mode + projection type

Wrapping modes:

1: planar box (deprecated),

- 2: box,
- 3: cylindrical,
- 4: spherical,
- 5: same as the cylindrical fill mapping, but in rendering the top and the bottom surface will get a circular mapping,
- 6: planar

Projection types:

- 256: the fill always starts at the origin of the local coordinate system,
- 1024: quadratic texture projection (recommended),
- 2048: linear texture projection based on the average distance,
- 4096: linear texture projection based on normal triangulation.

Note: The last three values are only effective with custom texture coordinate definitions (*see the TEVE command*).

vert1: index of a VERT, representing the origin of the local coordinate system.

vert2, vert3, vert4: indices of VERTs defining the three coordinate axes.

Use a minus sign (-) before VERT indices if they are used only for defining the local coordinate system.

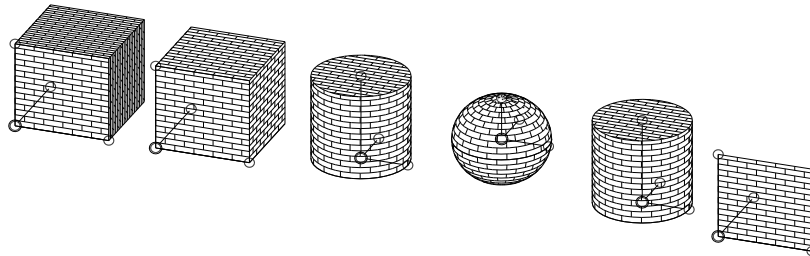

Example: For custom texture axes:

```
CSLAB_ "Brick-White", "Brick-White", "Brick-White",
      4, 0.5,
      0, 0, 0, 15,
      1, 0, 0, 15,
      1, 1, 1, 15,
      0, 1, 1, 15
BASE
VERT 1, 0, 0 !#1
VERT 1, 1, 1 !#2
VERT 0, 0, 0 !#3
VERT 1, 0, 1 !#4
COOR 2, -1, -2, -3, -4
BODY 1
```

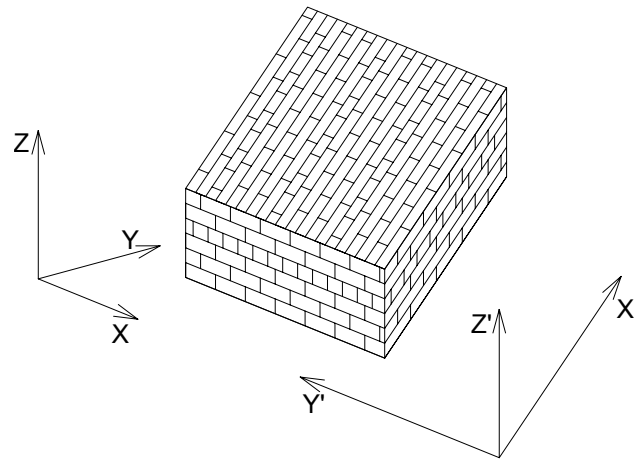

COOR{2}

COOR{2} wrap_method, wrap_flags, vert1, vert2, vert3, vert4

Deprecated. See the COOR{3} command.

Similar to the COOR command, changing wrap to two parameters wrap_method and wrap_flags, and also extending the possibilities of it.

wrap_method: Wrapping modes are the same as described in the the COOR command. Projection types don't apply, use `wrap_flags` instead.

wrap_flags: Wrapping flags

`wrap_flags = 4*j3 + 8*j4 + 16*j5 + 32*j6 + 64*j7 + 128*j8`, where each *j* can be 0 or 1.

*j*₃: quadratic texture projection (recommended),

*j*₄: linear texture projection based on the average distance,

*j*₅: linear texture projection based on normal triangulation,

*j*₈: translate the origin of the texture coordinate system closest to the global origin in the direction of the X, Y or Z axis respectively. For example, *j*₆ makes the origin translating in the direction of the X axis (along $v_2 - v_1$ vector) so that it will be the orthogonal projection of the global origin to the line of the X axis. That is, if all *j*₆, *j*₇ and *j*₈ are 1, the origin is translated into the global origin (same as if projection type is 256 in the the COOR command).

Note: The *j*₃, *j*₄ and *j*₅ flags are only effective if `wrap_method` is 0 and only one of them can be 1. The *j*₆, *j*₇ and *j*₈ flags are only effective if `wrap_method` is not 0. These can be 1 at the same time in any combination.

vert1, vert2, vert3, vert4: like in the COOR command.

COOR{3}

```
COOR{3} wrapping_method, wrap_flags,
        origin_X, origin_Y, origin_Z,
        endOfX_X, endOfX_Y, endOfX_Z,
        endOfY_X, endOfY_Y, endOfY_Z,
        endOfZ_X, endOfZ_Y, endOfZ_Z
```

Compatibility: introduced in ARCHICAD 20.

Similar to the COOR{2} command. Can be used with array parameter input (see WALL_TEXTURE_WRAP global in the section called “Wall parameters - available for Doors/Windows, listing and labels” for more).

The coordinate system of the projection body is included in the COOR{3} command itself, no need to define additional vertexes in the current BODY. Compatible with NURBS bodies (no non-NURBS primitives are needed to set up the texture coordinate system).

wrap_method: Wrapping modes are the same as described in the the COOR command supplemented by NURBS based wrapping mode. Projection types don't apply, use `wrap_flags` instead.

1: planar box (deprecated),

2: box,

3: cylindrical,

4: spherical,

- 5: same as the cylindrical fill mapping, but in rendering the top and the bottom surface will get a circular mapping,
- 6: planar,
- 7: NURBS based, the vertices' texture coordinates are from their surface parameters, only in case of NURBS bodies.

wrap_flags: Wrapping flags

$\text{wrap_flags} = 4*j_3 + 8*j_4 + 16*j_5 + 32*j_6 + 64*j_7 + 128*j_8$, where each j can be 0 or 1.

j_3 : quadratic texture projection (recommended),

j_4 : linear texture projection based on the average distance,

j_5 : linear texture projection based on normal triangulation,

j_8 : translate the origin of the texture coordinate system closest to the global origin in the direction of the X, Y or Z axis respectively. For example, j_6 makes the origin translating in the direction of the X axis so that it will be the orthogonal projection of the global origin to the line of the X axis. That is, if all j_6 , j_7 and j_8 are 1, the origin is translated into the global origin (opposite effect of projection type 256 in the the COOR command).

Note: The j_3 , j_4 and j_5 flags are only effective if `wrap_method` is 0 and only one of them can be 1. The j_6 , j_7 and j_8 flags are only effective if `wrap_method` is not 0. These can be 1 at the same time in any combination.

origin_X, origin_Y, origin_Z: node in the x-y-z space, defined by three coordinates, texture origin.

endOfX_X, endOfX_Y, endOfX_Z: node in the x-y-z space, defined by three coordinates, texture mapping X direction.

endOfY_X, endOfY_Y, endOfY_Z: node in the x-y-z space, defined by three coordinates, texture mapping Y direction.

endOfZ_X, endOfZ_Y, endOfZ_Z: node in the x-y-z space, defined by three coordinates, texture mapping Z direction.

Example: COOR{3} and equivalent COOR{2} parametrisation

```

COOR{3} wrapping_method, wrap_flags,
        origin_X, origin_Y, origin_Z,
        endOfX_X, endOfX_Y, endOfX_Z,
        endOfY_X, endOfY_Y, endOfY_Z,
        endOfZ_X, endOfZ_Y, endOfZ_Z

! COOR{2} equivalent
BASE
VERT    origin_X, origin_Y, origin_Z,
VERT    endOfX_X, endOfX_Y, endOfX_Z
VERT    endOfY_X, endOfY_Y, endOfY_Z
VERT    endOfZ_X, endOfZ_Y, endOfZ_Z
COOR{2} wrapping_method, wrap_flags, -1, -2, -3, -4

```

BODY

BODY status

Composes a body defined with the above primitives.

status: Status bits:

status = $j_1 + 2*j_2 + 4*j_3 + 32*j_6 + 64*j_7$, where each j can be 0 or 1.

j_1 : closed body (deprecated),

j_2 : body including curved surface(s) (deprecated),

j_3 : surface model: when the body is cut, no surface originates on the cutting plane,

j_6 : body always casts shadow independently from automatic preselection algorithm,

j_7 : body never casts shadow.

If neither j_6 nor j_7 are set, the automatic shadow preselection is performed.

See the SHADOW command.

If the status value is negative, the engine will calculate the status of the body.

Example:

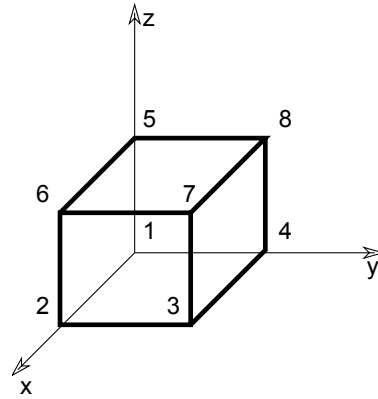

1: Complete description

```

VERT 0.0, 0.0, 0.0    !#1
VERT 1.0, 0.0, 0.0    !#2
VERT 1.0, 1.0, 0.0    !#3
VERT 0.0, 1.0, 0.0    !#4
VERT 0.0, 0.0, 1.0    !#5
VERT 1.0, 0.0, 1.0    !#6
VERT 1.0, 1.0, 1.0    !#7
VERT 0.0, 1.0, 1.0    !#8
EDGE 1, 2, 1, 3, 0    !#1
EDGE 2, 3, 1, 4, 0    !#2
EDGE 3, 4, 1, 5, 0    !#3
EDGE 4, 1, 1, 6, 0    !#4
EDGE 5, 6, 2, 3, 0    !#5
EDGE 6, 7, 2, 4, 0    !#6
EDGE 7, 8, 2, 5, 0    !#7
EDGE 8, 5, 2, 6, 0    !#8
EDGE 1, 5, 6, 3, 0    !#9
EDGE 2, 6, 3, 4, 0    !#10
EDGE 3, 7, 4, 5, 0    !#11
EDGE 4, 8, 5, 6, 0    !#12
VECT 1.0, 0.0, 0.0    !#1
VECT 0.0, 1.0, 0.0    !#2
VECT 0.0, 0.0, 1.0    !#3
PGON 4, -3, 0, -1, -4, -3, -2    !#1    !VERT1,2,3,4
PGON 4, 3, 0, 5, 6, 7, 8    !#2    !VERT5,6,7,8
PGON 4, -2, 0, 1, 10, -5, -9    !#3    !VERT1,2,5,6
PGON 4, 1, 0, 2, 11, -6, -10    !#4    !VERT2,3,6,7
PGON 4, 2, 0, 3, 12, -7, -11    !#5    !VERT3,4,7,8
PGON 4, -1, 0, 4, 9, -8, -12    !#6    !VERT1,4,5,8
BODY 1    !CUBE

```

2: (no direct reference to the polygons or the vectors, they will be calculated)

```

VERT 0.0, 0.0, 0.0      !#1
VERT 1.0, 0.0, 0.0      !#2
VERT 1.0, 1.0, 0.0      !#3
VERT 0.0, 1.0, 0.0      !#4
VERT 0.0, 0.0, 1.0      !#5
VERT 1.0, 0.0, 1.0      !#6
VERT 1.0, 1.0, 1.0      !#7
VERT 0.0, 1.0, 1.0      !#8
EDGE 1, 2, -1, -1, 0     !#1
EDGE 2, 3, -1, -1, 0     !#2
EDGE 3, 4, -1, -1, 0     !#3
EDGE 4, 1, -1, -1, 0     !#4
EDGE 5, 6, -1, -1, 0     !#5
EDGE 6, 7, -1, -1, 0     !#6
EDGE 7, 8, -1, -1, 0     !#7
EDGE 8, 5, -1, -1, 0     !#8
EDGE 1, 5, -1, -1, 0     !#9
EDGE 2, 6, -1, -1, 0     !#10
EDGE 3, 7, -1, -1, 0     !#11
EDGE 4, 8, -1, -1, 0     !#12
PGON 4, 0, -1, -1, -4, -3, -2 !#1
!VERT1,2,3,4
PGON 4, 0, -1, 5, 6, 7, 8    !#2
!VERT5,6,7,8
PGON 4, 0, -1, 1, 10, -5, -9 !#3
!VERT1,2,5,6
PGON 4, 0, -1, 2, 11, -6, -10 !#4
!VERT2,3,6,7
PGON 4, 0, -1, 3, 12, -7, -11 !#5
!VERT3,4,7,8
PGON 4, 0, -1, 4, 9, -8, -12 !#6
!VERT1,4,5,8
BODY -1                      !CUBE

```

BASE

BASE

Resets counters for low-level geometric elements (VERT, TEVE, VECT, EDGE, PGON and PIPG) statements. Implicitly issued after every compound element definition.

NURBS PRIMITIVE ELEMENTS

The primitives of 3D data structure of NURBS bodies are the NURBSCURVE2D command, the NURBSCURVE3D command, the NURBSSURFACE command, the NURBSVERT command, the NURBSEDGE command, the NURBSTRIM command, the NURBSTRIMSINGULAR command, the NURBSFACE command, the NURBSLUMP command, and the NURBSBODY command.

Solid NURBS bodies are represented by the boundary NURBS faces of the solid region(s), laminar surface NURBS bodies are represented by the NURBS faces themselves, wire NURBS bodies are represented by the NURBS edges. A NURBS body can have solid, laminar and wire part at the same time, a NURBS body itself is not classified into solid/surface/wire categories.

Nurbs primitives can not be used in planar face bodies and non-NURBS primitives can not be used in NURBS bodies. A non-NURBS primitive statement causes the NURBS body under construction to be finished and a new non-NURBS body to be started (implicit BODY and NURBSBODY statements).

Similarly a NURBS primitive statement causes the non-NURBS body under construction to be finished and a new NURBS body to be started. A compound statement (BRICK, CYLIND, PRISM, etc.) or a MODEL statement causes either NURBS or non-NURBS body under construction to be finished. If a NURBSBODY statement closes a non-NURBS body or a BODY statement closes a NURBS body, the given status value will have no effect.

Indexing of NURBS primitives starts from 1. Indexing of NURBS primitives and non-NURBS primitives (VERT, TEVE, EDGE, VECT, PGON, PIPG) are handled separately. The BASE statement resets counter for NURBS body primitives also. All primitives referenced by another primitive should be defined before the referencing one (e.g. vertices and 3D curve of edge should be defined before the edge).

The NURBSCURVE2D, NURBSCURVE3D and NURBSSURFACE statements create only geometric elements in the NURBS body which will not be visible themselves. A NURBS edge defines its geometric support by referencing a 3D NURBS curve, similarly a NURBS trim references a 2D NURBS curve and a NURBS face references a NURBS surface as its geometric support (the edge, trim and face may not extend to the whole geometric support, see details at each command description).

The NURBS edge, its 3D curve, its trims, and the 2D curves of the trims are always oriented consistently. The NURBS face and its surface are always oriented consistently.

The NURBS faces may be organized into NURBS lumps. A lump defines a solid region bounded by one or more shells. A shell is a closed and connected set of faces which separates the space into two regions. A lump has an outer shell which separates the lump from the infinity and may have void shells which separate the lump from inner cavities.

Consistent orientation of faces in a shell is not necessary, two neighbouring face can refer to the same edge in the same direction. But shells of lump must have consistent orientations, the back side of a shell should look toward the interior of the lump, for this the lump can refer to the faces with negative prefix for reversed orientation.

Faces which are not part of a lump will be treated as laminar surfaces, even if the faces form a closed shell. Edges which are not part of a face will be treated as wire edges. One NURBS body can contain solid lumps, laminar faces and wire edges at the same time.

The 2-manifold property is not required for NURBS bodies, a NURBS edge may be connected to more than two faces (by more than two trims). Even a shell of a NURBS lump can have more than two faces at an edge as long as the shell still separates the space into two regions (this means even number of faces of a given shell on each edge).

The RADIUS, RESOL and TOLER statements have no effect on the smoothness of the NURBS faces and edges. The smoothness of NURBS primitives is calculated automatically and may be limited for a NURBS body by the parameters of the NURBSBODY command (see details at NURBSBODY).

For correct texture setting for NURBS, see the the COOR{3} command.

NURBS Face trimming

A NURBS surface is a two dimensional sheet in the three dimensional space and is defined by a geometric function mapping a rectangle to the space. The geometry of a NURBS face is always a part of a NURBS surface but may be more complex than that. This is made possible by trims. A trim defines a cut on the domain rectangle of the surface, a cut with a two dimensional NURBS curve. This implies a cut on the three dimensional sheet of the surface. This cut lies along the bounding NURBS edge of the face and the geometry of the cut along the surface sheet must be consistent with the geometry of the NURBS edge.

A NURBS face has contours just like a traditional PGON, but the contours are not lists of NURBS edges but NURBS trims because the trims have the information needed to cut the face properly. (The 2d curve of trims may be computed from the 3d curve of the edge but it may be inaccurate or even ambiguous in case of surfaces with self-intersection or singularities or in case of erroneous data.)

NURBS Geometry Commands

The following commands describe geometric parts of NURBS elements: curves and surface.

NURBSCURVE2D

```
NURBSCURVE2D degree, nControlPoints,
    knot_1, knot_2, ..., knot_m,
    cPoint_1_x, cPoint_1_y, weight_1,
    cPoint_2_x, cPoint_2_y, weight_2,
    ...,
    cPoint_n_x, cPoint_n_y, weight_n
```

NURBSCURVE3D

```
NURBSCURVE3D degree, nControlPoints,
    knot_1, knot_2, ..., knot_m,
    cPoint_1_x, cPoint_1_y, cPoint_1_z, weight_1,
    cPoint_2_x, cPoint_2_y, cPoint_2_z, weight_2,
    ...
    cPoint_n_x, cPoint_n_y, cPoint_n_z, weight_n
```

2 and 3 dimensional NURBS curves with given degree, knotvector, controlpoints and weights.

degree: degree of NURBS curve, one less than order of curve (order = degree + 1), positive

nControlPoints: number of control points (n), greater than the degree of the curve (not less than the order)

knot_i: index i knot value

- number of knot values (m, the size of knot vector) is given by the following: $m = \text{degree} + 1 + n$
- knots are in non-descending order ($\text{knot}_i \leq \text{knot}_{i+1}$)
- equal knot values are allowed, with multiplicity up to degree+1 for the first and last knot.

cPoint_i_x, cPoint_i_y, cPoint_i_z: coordinates of index i control point

weight_i: weight of index i control point, positive

Periodic curves are not handled separately, but described as floating (not clamped) NURBS curves which are geometrically closed and have appropriately continuous connection at the the ends. This is ensured by repeating sufficient number of control points and knot-intervals at the end:

- the last degree many control points are duplicates of the first degree many control points (not in reverse order),
- the first twice-the-degree number of knot-differences ($\text{knot}_1 - \text{knot}_0, \text{knot}_2 - \text{knot}_1, \dots$) are the same as the last ones in the knot vector (these are the knots which are in connection with the first (or last) degree many control points).

The usable domain of a curve is the closed interval between $\text{knot}_{\{\text{degree} + 1\}}$ and $\text{knot}_{\{m - \text{degree}\}}$.

NURBSSURFACE

```
NURBSSURFACE degree_u, degree_v, nu, nv,
    knot_u_1, knot_u_2, ..., knot_u_mu,
    knot_v_1, knot_v_2, ..., knot_v_mv,
    cPoint_1_1_x, cPoint_1_1_y, cPoint_1_1_z, weight_1_1,
    cPoint_1_2_x, cPoint_1_2_y, cPoint_1_2_z, weight_1_2,
    ...,
    cPoint_1_nv_x, cPoint_1_nv_y, cPoint_1_nv_z, weight_1_nv,
    cPoint_2_1_x, cPoint_2_1_y, cPoint_2_1_z, weight_2_1,
    ...,
    cPoint_nu_nv_x, cPoint_nu_nv_y, cPoint_nu_nv_z, weight_nu_nv
```

3-dimensional NURBS surface with u-v parameter space, given degree, knotvectors in u and v directions and given controlpoint, weight net. Degrees are one less than orders of surface (order_u = degree_u + 1), degrees are positive.

degree_u: degree of surface in the u parameter direction

degree_v: degree of surface in the v parameter direction

nu, nv: number of control points in u and v directions, greater than degree (not less than order) of then surface in given direction

knot_u_i, knot_v_i: index i knot value in u and v directions

- their number (the size of knot vector) is given by the following: $\mu = \text{degree}_u + 1 + \text{nu}$
- knots are in non-descending order ($\text{knot}_{u_i} \leq \text{knot}_{u_{i+1}}$, $\text{knot}_{v_i} \leq \text{knot}_{v_{i+1}}$)
- equal knot values are allowed, with multiplicity up to degree, or with multiplicity up to degree+1 for the first and last knot.

cPoint_i_j_x, cPoint_i_j_y, cPoint_i_j_z: control point on the control point net, index i in the u direction, index j in the v direction

weight_i_j: weight for control point cPoint_ij, positive

Surfaces may be periodic in either (u or v) direction or in both directions. Periodic surfaces are not handled separately, but described as floating (not clamped) NURBS surfaces which are geometrically closed and have appropriately continuous connection at the the ends. This is ensured the same way as in case of curves.

The usable domain of a surface is the cross product of the closed intervals between $\text{knot}_{u_{\{\text{degree}_u + 1\}}}$, $\text{knot}_{u_{\{\mu - \text{degree}_u\}}}$ and $\text{knot}_{v_{\{\text{degree}_v + 1\}}}$, $\text{knot}_{v_{\{\mu - \text{degree}_v\}}}$ respectively.

NURBS Topology Commands

The following commands describe topological parts of NURBS elements.

NURBSVERT

NURBSVERT *x, y, z, hard, tolerance*

Vertex, a node of a NURBS body. Different from any vertex created by the VERT command, indexed separately from those. Can be used in NURBS bodies only, excluding planar-face bodies.

x, y, z: coordinates of vertex

hard:

- 1: if the vertex should define a break when rendering smooth surfaces,
- 0: otherwise.

tolerance: maximum geometric distance between NURBS vertex and other entities (NURBS edge, NURBS face) which are topologically connected to it. If negative, tolerance will be some predefined default.

NURBSEGE

NURBSEGE *vert1, vert2, curve, curveDomainBeg, curveDomainEnd, status, tolerance*

Edge of a NURBS body. Different from any edge created by the EDGE command, indexed separately from those. Can be used in NURBS bodies only, excluding planar-face bodies.

vert1, vert2: gdl-index of begin and end NURBS vertices

- vert1 and vert2 can be equal. In this case the edge is a loop edge (and its curve is closed or has a closed part)
- vert1 and vert2 can be zero for a ring edge (which has no vertices and its curve is closed or has a closed part)

curve: gdl-index of NURBS curve for the geometry of edge. Positive index, orientation of edge always coincide with orientation of the curve.

curveDomainBeg, curveDomainEnd: definition of the part of curve which geometrically represents the edge. The curveDomainEnd must be greater than curveDomainBeg, they must not coincide, and both value must be in the usable domain of the curve.

status: status control of the edge:

$status = j_1 + 2*j_2 + 4*j_3$, where each j can be 0 or 1.

j_1 : invisible edge (may be set only if j_2 is not set).

j_2 : edge only visible if contour (may be set only if j_1 is not set).

j_3 : smooth edge (edge does not define a break when rendering smooth surfaces).

If both j_1 and j_2 are set, the edge will produce an error causing the whole NURBS-body to vanish.

tolerance: maximum geometric distance between NURBS edge and other entities (NURBS face) which are topologically connected to it. If negative, tolerance will be some predefined default.

The curve evaluated at each endpoint should coincide with the position of the appropriate vertex. The edge can be a ring edge with no vertex. In this case the edge restricted to [curveDomainBeg, curveDomainEnd] must be closed, i.e. it evaluates equally at each endpoints. Any number of edges can be attached to a vertex. The color of a NURBS edge is defined by the last PEN statement.

NURBSTRIM

NURBSTRIM edge, curve, curveDomainBeg, curveDomainEnd, tolerance

NURBSTRIMSINGULAR

NURBSTRIMSINGULAR vertex, curve, curveDomainBeg, curveDomainEnd, tolerance

A bounding edge of a face. Used for trimming a face in the parameter space of the surface of the face. NURBSTRIMSINGULAR is used along singular sides of the surface (which side is contracted to one point on the surface). Connects the face to an edge (or to a vertex in singular case).

edge: gdl-index of NURBS edge to which this trim is attached. Positive index, edge and trim are always oriented consistently.

vertex: gdl-index of NURBS vertex to which this trim is attached (singular case).

curve: gdl-index of a 2D NURBS curve. Positive index, curve and trim are always oriented consistently. It is defined on the domain (u-v parameter space) of the surface of the face.

curveDomainBeg, curveDomainEnd: definition of the part of curve which geometrically represents the trim. The curveDomainEnd must be greater than curveDomainBeg, they must not coincide, and both value must be in the usable domain of the curve.

tolerance: maximum geometric distance between 2D curve of NURBS trim and other entities (other NURBS trims) which are topologically connected to it. If negative, tolerance will be some predefined default.

The curve restricted to [curveDomainBeg, curveDomainEnd] interval should completely lie within the usable domain of the surface of the face (with given tolerance). For NURBSTRIMSINGULAR the 2D curve must lie along a singular side of the usable domain (u-v parameter space) of the surface of the face.

The composition of the restricted 2D curve and the surface gives a 3D curve which should coincide with the restricted 3D curve of the edge. Therefore the 2D curve evaluated at curveDomainBeg and curveDomainEnd should coincide with the position of the appropriate vertex. In the singular case the composition of the 2D curve and the surface gives a 3D point, which should coincide with the given vertex.

Indexing of singular and non-singular trims is common.

Any number of trims can refer to each edge (so indirectly any number of face can be attached to an edge). The edge can be non-2-manifold.

Two trims on one edge may belong to the same face, in this case edge is called a seam edge. For example a mantle of a cylinder can be one face with a seam edge.

NURBSFACE

NURBSFACE *n*, *surface*, *tolerance*,
trim1, *trim2*, ..., *trimn*

Face of a NURBS body. Different from any polygon created by the PGON command, indexed separately from those. Can be used in NURBS bodies only, excluding planar-face bodies.

n: number of bounding edges (including optional hole-separator zeros).

surface: gdl-index of a NURBS surface supporting the face. Positive index, orientation of face is always identical to the orientation of surface.

trimi: gdl-index of NURBS trim bounding the face.

- The trims are listed in a counter-clockwise (mathematical positive) order on the surface for the outer contour loop and clockwise (negative) for hole contour loop(s).
- May be zero, which indicates end of contour (hole-separator).
- Negative index means trim and the contour (of face) have opposite orientation.

tolerance: if negative, tolerance will be some predefined default.

The trims must connect at common vertices: the end vertex of a trim is the same as the begin vertex of the next trim in the face. (The vertices of a trim are the vertices of the edge of the trim for a non-singular trim.)

The consecutive trims - as 2D curves - also connect in the domain (parameter space) of the face, defining one or more closed contour loops on it. The first loop is always an outer loop which separates an infinite outer and a finite inner region on the plane. The potential subsequent loops are hole contours.

The 2D curve of each trim should completely lie inside the usable domain of the surface of the face and should not intersect itself or curves of other trims of the face. Each trim must be used in only one face.

The material and section attributes of a face are determined by the last MATERIAL and SECT_ATTRS (or SECT_FILL) statements respectively. The color of the edges inside the face created for polygonal segmentations is defined by the last PEN statement. This is practically visible on silhouettes coming from the internal of this face.

NURBSFACE{2}

```
NURBSFACE{2} n, surface, tolerance,
              wrap_method, wrap_flags,
              x1, y1, z1,
              x2, y2, z2,
              x3, y3, z3,
              x4, y4, z4,
              trim1, trim2, ..., trimn
```

Similar to the NURBSFACE command, extended with the ability to describe texture mapping on the NURBS face like in the PGON{3} command.

n, surface, tolerance: same as the NURBSFACE command.

wrap_method: same as the PGON{3} command.

- 0: the global wrapping mode is applied (x1 ... z4 parameters are required but will be ignored)
- > 0: same as the PGON{3} command

wrap_flags: similar to the the PGON{3} command, except that projection type flags (j3, j4 and j5) are ignored (texture coordinates can not be applied on NURBS faces).

x1, y1, z1 ... x4, y4, z4: coordinates defining the coordinate system of the texture mapping for the NURBS face (these parameters are effective only if wrap_method > 0).

trim1 ... trimn: same as the NURBSFACE command.

NURBSLUMP

```
NURBSLUMP n, face1, face2, ..., facen
```

Defines a solid part - a geometrically connected subset - of a solid NURBS body.

n: number of bounding faces (including optional void-separator zeros).

facei: gdl-index of NURBS face bounding the lump

- May be zero, indicating the end of shell and the beginning of another shell (void-separator).
- Negative index means face is used in opposite direction. For positive index the backward side of the face correspond to the interior of the lump, for negative index the front side looks to the interior.

The boundary of a lump may fall to several closed shells: one outer shell which separates the lump from the infinite outer region of the space; and zero or more inner - void - shells which separate the lump from cavity regions. The faces of one shell must compose a continuous part

of the face list. These different parts for different shells must be separated by a 0 value. The first shell must be the outer shell. The faces of a shell must connect at common edges, but no ordering is assumed in the list.

Note that the faces of a shell may be connected to other faces which are not in the shell or are in another shell (because edges can have more than two faces). Each face must be used in only one lump. Neither shell of a lump can be open - open bodies have no lumps and no shells.

NURBSBODY

NURBSBODY shadowStatus, smoothnessMin, smoothnessMax

Composes a NURBS body defined with the above NURBS primitives.

shadowStatus: status for shadow control:

shadowStatus = $32*j_6 + 64*j_7$, where each j can be 0 or 1.

j_6 : NURBS body always casts shadow independently from automatic preselection algorithm,

j_7 : NURBS body never casts shadow.

If neither j_6 nor j_7 are set, the automatic shadow preselection is performed. See the SHADOW command.

smoothnessMin, smoothnessMax: limits of automatically calculated smoothness parameter for tessellation of the surfaces and curves of body. The automatically calculated parameter will be always in the range 0 to 1 inclusive, so that smoothnessMin ≤ 0 means no lower limit and smoothnessMax ≥ 1 means no upper limit. If smoothnessMin $>$ smoothnessMax, values will not affect the automatically calculated smoothness.

Any non-NURBS primitive statement (VERT, TEVE, EDGE, VECT, PGON, PIPG, BODY) or any compound statement (BRICK, CYLIND, PRISM, REVOLVE, etc.) causes the NURBS body under construction to be finished (implicit NURBSBODY statement). In this case smoothness limits will not be set and shadowStatus will be zero (status parameter of BODY statement will not be passed).

POINT CLOUDS

POINTCLOUD

POINTCLOUD "data_file_name"

Generates a point cloud in the 3D model. A point cloud is a set of 3D points with color and other possible metadata stored per each point.

data_file_name: the name of the loaded library part containing the point cloud data. Must be a string expression.

Point clouds are not displayed by the Internal 3D Engine. The 2D is projected, using cutplanes to filter the unnecessary points.

CUTTING IN 3D

CUTPLANE

```
CUTPLANE [x [, y [, z [, side [, status]]]]]
[statement1 ... statementn]
CUTEND
```

CUTPLANE{2}

```
CUTPLANE{2} angle [, status]
[statement1 ... statementn]
CUTEND
```

CUTPLANE{3}

```
CUTPLANE{3} [x [, y [, z [, side [, status]]]]]
[statement1 ... statementn]
CUTEND
```

Creates a cutting plane and removes the cut parts of enclosed shapes. CUTPLANE may have a different number of parameters.

If CUTPLANE has the following number of parameters:

0: x-y plane;

1: cutting plane goes across x axis, angle is between cutting plane and x-y plane;

2: cutting plane is parallel to z axis, crosses x axis and y axis at the given values;

3: cutting plane crosses the x, y and z axes at the given values;

4: the first three parameters are as above, with the addition of the side value as follows:

side: definition of the side to cut.

0: removes parts above cutting plane (default),

1: removes parts below cutting plane; in case of x-y, x-z, y-z, removes the parts in the negative direction of the axis.

status: status control of the cut surfaces. If the status is not given the status is set to 1+2 automatically.

$status = j_1 + 2*j_2 + 4*j_3 + 256*j_9$, where each j can be 0 or 1.

j_1 : use the attributes of the body for the generated polygons and edges.

j_2 : generated cut polygons will be treated as normal polygons.

j_3 : generated cut edges will be invisible.

j_9 : vertices on the cutting plane are treated as removed.

The cut (without the side parameter) removes parts above the cutting plane. If the first three parameters define the x-y, x-z or y-z plane (for example, 1.0, 1.0, 0.0 defines the x-y plane), the parts in the positive direction of the third axis are removed.

Any number of statements can be added between CUTPLANE and CUTEND. It is also possible to include CUTPLANEs in macros. CUTPLANE parameters refer to the current coordinate system.

Transformations between CUTPLANE and CUTEND have no effect on this very cutting plane, but any successive CUTPLANEs will be transformed. Therefore, it is recommended to use as many transformations to set up the CUTPLANE as necessary, then delete these transformations before you define the shapes to cut.

If transformations used only to position the CUTPLANE are not removed, you may think that the CUTPLANE is at a wrong position when, in reality, it is the shapes that have moved away.

Pairs of CUTPLANE-CUTEND commands can be nested, even within loops. If the final CUTEND is missing, its corresponding CUTPLANE will be effective on all shapes until the end of the script.

Note 1: If CUTPLANE is not closed with CUTEND, all shapes may be entirely removed. That's why you always get a warning message about missing CUTENDs.

CUTPLANEs in macros affect shapes in the macro only, even if CUTEND is missing.

If a macro is called between CUTPLANE and CUTEND, the shapes in the macro will be cut.

Note 2: If you use CUTPLANE{2} with more than two parameters, then this will act like CUTPLANE.

Note 3: Prefer using CUTPLANE{3} instead of CUTPLANE. If you use CUTPLANE with 5 parameters, then the 4th parameter will be omitted. For CUTPLANE{3}, this parameter has effect independently from the 5th parameter.

Example 1:

```

CUTPLANE 2, 2, 4
CUTPLANE -2, 2, 4
CUTPLANE -2, -2, 4
CUTPLANE 2, -2, 4
ADD -1, -1, 0
BRICK 2, 2, 4
DEL 1
CUTEND
CUTEND
CUTEND
CUTEND

```

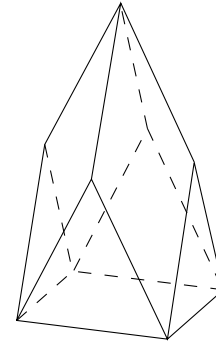

Example 2:

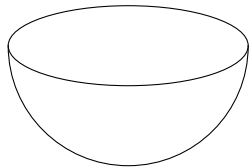

```

CUTPLANE
SPHERE 2
CUTEND

```

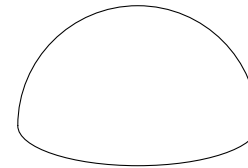

```

CUTPLANE 1, 1, 0, 1
SPHERE 2
CUTEND

```

Example 3:

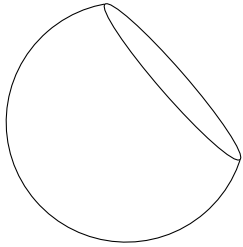

```
CUTPLANE 1.8, 1.8, 1.8  
SPHERE 2  
CUTEND
```

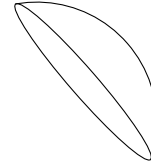

```
CUTPLANE 1.8, 1.8, 1.8, 1  
SPHERE 2  
CUTEND
```

Example 4:

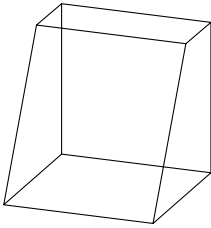

```
CUTPLANE 60  
BRICK 2, 2, 2  
CUTEND
```

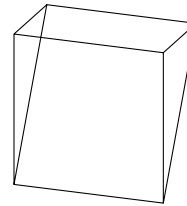

```
CUTPLANE -120  
BRICK 2, 2, 2  
CUTEND
```

CUTPOLY

```
CUTPOLY n,  
          x1, y1, ..., xn, yn  
          [, x, y, z]  
[statement1  
statement2  
...  
statementn]
```

CUTEND

Similarly to the CUTPLANE command, parameters of CUTPOLY refer to the current coordinate system. The polygon cannot be self-intersecting. The direction of cutting is the Z axis or an optional (x, y, z) vector can be specified. Mirroring transformations affect the cutting direction in an unexpected way - to get a more straightforward result, use the CUTFORM command.

Example 1:

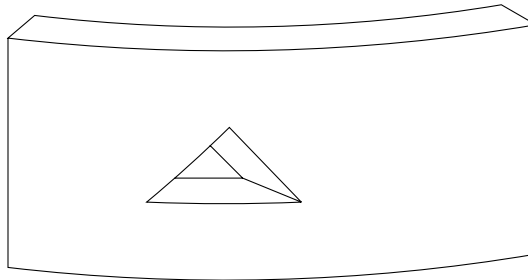

```

ROTX 90
MULZ -1
CUTPOLY 3,
        0.5, 1,
        2, 2,
        3.5, 1,
        -1.8, 0, 1
DEL 1
BPRISM_ "Brick-Red", "Brick-Red", "Brick-White",
        4, 0.9, 7,
        0.0, 0.0, 15,
        6.0, 0.0, 15,
        6.0, 3.0, 15,
        0.0, 3.0, 15
CUTEND

```

Example 2:

```

a=1.0
d=0.1
GOSUB "rect_cut"
ROTX 90
GOSUB "rect_cut"
DEL 1
ROTY -90
GOSUB "rect_cut"
DEL 1
BLOCK a, a, a
CUTEND
CUTEND
CUTEND
END
"rect_cut":
    CUTPOLY 4,
            d, d,
            a-d, d,
            a-d, a-d,
            d, a-d
    RETURN

```

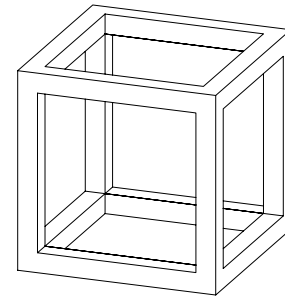

Example 3:

```

ROTX 90
FOR i=1 TO 3
  FOR j=1 TO 5
    CUTPOLY 4,
            0, 0, 1, 0,
            1, 1, 0, 1
    ADDX 1.2
  NEXT j
  DEL 5
  ADDY 1.2
NEXT i
DEL NTR()-1
ADD -0.2, -0.2, 0
BRICK 6.2, 3.8, 1
FOR k=1 TO 15
  CUTEND
NEXT k
DEL TOP

```

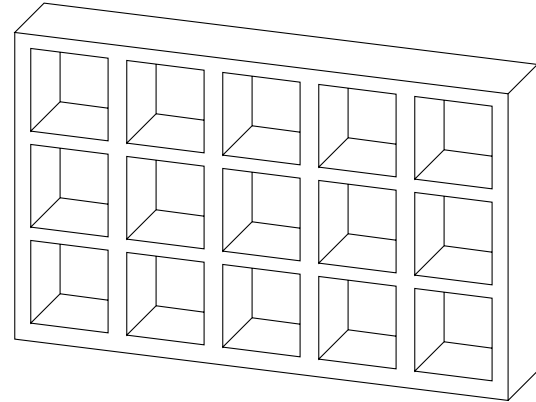

CUTPOLYA

```

CUTPOLYA n, status, d,
           x1, y1, mask1, ..., xn, yn, maskn [,
           x, y, z]
[statement1
statement2
...
statementn]
CUTEND

```

Similar to the CUTPOLY command, but with the possibility to control the visibility of the edges of the generated polygons. The cutting form is a half-infinite tube with the defined polygonal cross-section. If the end of the cutting form hangs down into the body, it will cut out the corresponding area.

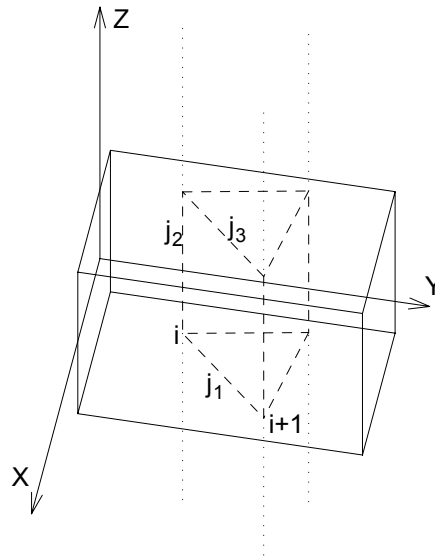

status: controls the treatment of the generated cut polygons.

- 1: use the attributes of the body for the generated polygons and edges,
- 2: generated cut polygons will be treated as normal polygons.

d: the distance between the local origin and the end of the half-infinite tube.

- 0: means a cut with an infinite tube.

maski: similar to the PRISM_ command.

$\text{maski} = j_1 + 2*j_2 + 4*j_3 + 64*j_7$, where each j can be 0 or 1.

Example:

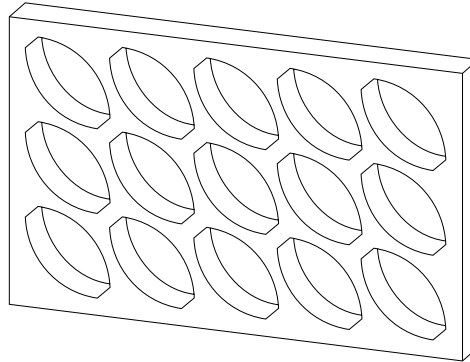

```

ROTX 90
FOR i=1 TO 3
  FOR j=1 TO 5
    CUTPOLYA 6, 1, 0,
      1, 0.15, 5,
      0.15, 0.15, 900,
      0, 90, 4007,
      0, 0.85, 5,
      0.85, 0.85, 900,
      0, 90, 4007
    ADDX 1
  NEXT j
  DEL 5
  ADDY 1
NEXT i
DEL NTR()-1
ADD -0.2, -0.2, 0
BRICK 5.4, 3.4, 0.5
FOR k=1 TO 15
  CUTEND
NEXT k
DEL TOP

```

CUTSHAPE

CUTSHAPE d [, status]
 [statement1 statement2 ... statementn]

CUTEND

Cuts a block with "d" thickness, infinite length (both sides of the y axis) and semi-infinite height (above the xy plane).

status: controls the treatment of the generated cut polygons. If not specified (for compatibility reasons) the default value is 3.

status = $j_1 + 2*j_2$, where each j can be 0 or 1.

j_1 : use the attributes of the body for the generated polygons and edges,

j_2 : generated cut polygons will be treated as normal polygons.

Example:

```
FOR i = 1 TO 5
  ADDX 0.4 * i
  ADDZ 2.5
  CUTSHAPE 0.4
  DEL 2
  ADDX 0.4
NEXT i
DEL TOP
BRICK 4.4, 0.5, 4
FOR i = 1 TO 5
  CUTEND
NEXT i
```

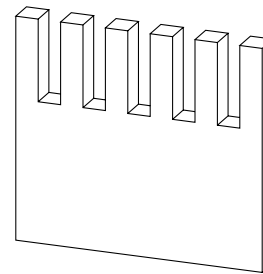

CUTFORM

CUTFORM n, method, status,
 rx, ry, rz, d,
 x1, y1, mask1 [, mat1],
 ...
 xn, yn, maskn [, matn]

Similar to the CUTPOLYA command, but with the possibility to control the form and extent of the cutting body.

method: controls the form of the cutting body.

1: prism shaped,

2: pyramidal,

3: wedge-shaped cutting body. The direction of the wedge's top edge is parallel to the Y axis and its position is in rx, ry, rz (ry is ignored).

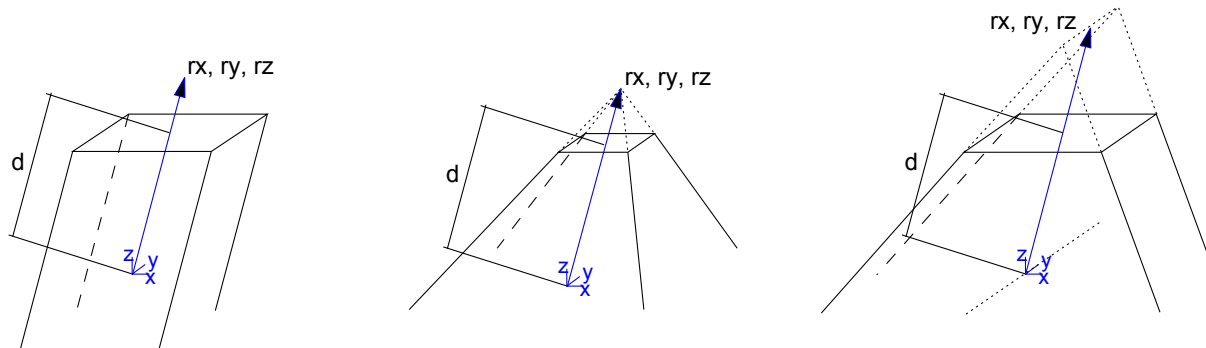

status: Controls the extent of the cutting body and the treatment of the generated cut polygons and new edges.

$status = j_1 + 2*j_2 + 8*j_4 + 16*j_5 + 32*j_6 + 64*j_7 + 128*j_8 + 256*j_9$, where each j can be 0 or 1.

j_1 : use the attributes of the body for the generated polygons and edges,

j_2 : generated cut polygons will be treated as normal polygons,

j_4 : define the limit of the cut (with j_5),

j_5 : define the limit of the cut (with j_4):

j_6 : generate a boolean intersection with the cutting body rather than a boolean difference. (can only be used with the CUTFORM command),

j_7 : edges generated by the bottom of the cutting body will be invisible,

j_8 : edges generated by the top of the cutting body will be invisible,

j_9 : cutting shape has custom side materials (matl).

$j_4 = 0$ and $j_5 = 0$: finite cut

$j_4 = 0$ and $j_5 = 1$: semi-infinite cut

$j_4 = 1$ and $j_5 = 1$: infinite cut

rx, ry, rz: these three coordinates define the direction of cutting if the cutting form is prism-shaped; these three coordinates define the top point of the pyramid if the method of cutting is pyramidal; rx-rz coordinates define the end edge of the wedge and ry is ignored if the cutting form is wedge-shaped

d: defines the distance along rx, ry, rz to the end of the cut. If the cut is infinite, this parameter has no effect. If the cut is finite, then the start of the cutting body will be at the local coordinate system and the body will end at a distance of d along the direction defined by rx, ry, rz.

If the cut is semi-infinite, then the start of the cutting body will be at a distance of d along the direction defined by rx , ry , rz , and the direction of the semi-infinite cut will be in the opposite direction defined by rx , ry , rz .

mask: defines the visibility of the edges of the cutting body.

$mask = j_1 + 2*j_2 + 4*j_3 + 8*j_4 + 16*j_5 + 64*j_7$, where each j can be 0 or 1.

j_1 : the polygon will create a visible edge upon entry into the body being cut (except when cutting solid body with wedge-shaped cutform, see below),

j_2 : the lengthwise edge of the cutting form will be visible,

j_3 : polygon will create a visible edge upon exiting the body being cut (except when cutting solid body with wedge-shaped cutform, see below),

j_4 : the bottom edge of the cutting form will be visible,

j_5 : the top edge of the cutting form will be visible,

j_7 : controls the viewpoint dependent visibility of the lengthwise edge.

In case of cutting solid body with wedge-shaped cutform the values for visibility of entry-edges and exit-edges (j_1 and j_3) are swapped. This behavior is kept for compatibility reasons.

mati: side material of the cutting shape (when status $j_9 = 1$)

CUTFORM{2}

```
CUTFORM{2} n, method, status,
            rx, ry, rz, d,
            x1, y1, mask1 [, mat1],
            ...
            xn, yn, maskn [, matn]
```

CUTFORM{2} is an extension of the CUTFORM command with the possibility of using inline material definition, that means materials defined in GDL script locally also can be used next to materials defined in global material definitions.

SOLID GEOMETRY COMMANDS

GDL is capable of performing specialized 3D operations between solids represented by groups. These operations can be one of the following:

ADDGROUP

forming the Boolean union of two solids

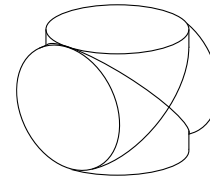

SUBGROUP

forming the Boolean difference of two solids

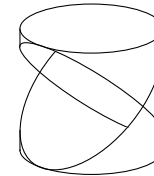

ISECTGROUP

forming the Boolean intersection of two solids

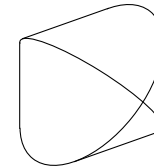

ISECTLINES

calculating the intersection lines of two solids

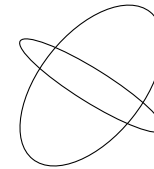

SWEEPGROUP

sweeping a solid along a vector

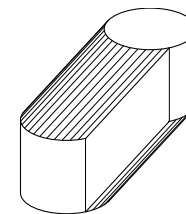

A GDL solid is composed of one or more lumps that appear as separated bodies in the model. A lump has exactly one outer shell and may contain voids. (Voids can be described as "negative" inner shells inside a lump.) The solid in the drawing below is composed of two lumps in such a way that one of them contains a void.

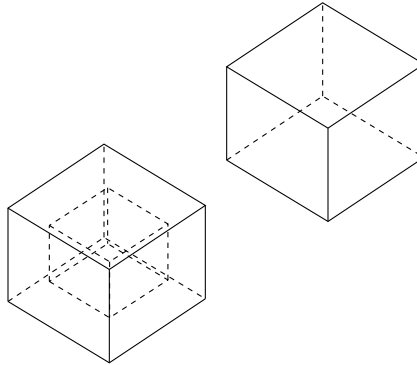

GDL bodies such as BLOCK, SPHERE, etc., appear as outer shells in groups. By means of the following construction the user is capable of putting more than one shell in a solid (note the BODY -1 statement):

```
GROUP "myGroup"
  BLOCK 1,1,1
  BODY -1
  ADDX 1
  BLOCK 1,1,1
ENDGROUP
```

The above solid contains two lumps; each of them is composed of one shell. Voids can be defined by means of primitives, or can occur as a result of a Boolean difference (e.g. subtracting a small cube from the middle of a big one).

See also the section called "Primitive Elements".

Although group operations are intended to work with solid objects, they can be applied to surfaces, wireframes or hybrid models, too. (Hybrid models are basically surfaces that may contain edges without neighboring faces.) The result of the operations on such models are summarized in the following tables:

Table 1. Union (*base » tool*)

	solid base	surface base	wireframe base	hybrid base
solid tool	solid result	surface result (merging)	wireframe result (merging)	hybrid result (merging)
surface tool	surface result (merging)	surface result (merging)	hybrid result (merging)	hybrid result (merging)
wireframe tool	wireframe result (merging)	hybrid result (merging)	wireframe result (merging)	hybrid result (merging)
hybrid tool	hybrid result (merging)	hybrid result (merging)	hybrid result (merging)	hybrid result (merging)

Table 2. Difference (*base \ tool*)

	solid base	surface base	wireframe base	hybrid base
solid tool	solid result	surface result	wireframe result	hybrid result
surface tool	surface base (no effect)	surface base (no effect)	hybrid base (no effect)	hybrid base (no effect)
wireframe tool	wireframe base (no effect)	hybrid base (no effect)	wireframe base (no effect)	hybrid base (no effect)
hybrid tool	hybrid base (no effect)	hybrid base (no effect)	hybrid base (no effect)	hybrid base (no effect)

Table 3. Intersection (*base « tool*)

	solid base	surface base	wireframe base	hybrid base
solid tool	solid result	surface result	wireframe result	hybrid result
surface tool	surface result	empty result	empty result	empty result
wireframe tool	wireframe result	empty result	empty result	empty result
hybrid tool	hybrid result	empty result	empty result	empty result

Table 4. Intersection lines (base « tool)

	solid base	surface base	wireframe base	hybrid base
solid tool	wireframe result	wireframe result	empty result	wireframe result
surface tool	wireframe result	empty result	empty result	empty result
wireframe tool	empty result	empty result	empty result	empty result
hybrid tool	wireframe result	empty result	empty result	empty result

Table 5. Sweeping

solid	surface	wireframe	hybrid
valid result	surface base (no effect)	wireframe base (no effect)	hybrid base (no effect)

Surfaces can be explicitly generated by using the MODEL SURFACE command, or implicitly by leaving out non-neighboring face polygons from the model. Wireframes are produced either by using the MODEL WIRE statement or by defining objects without face polygons. Hybrid models can only be generated indirectly by leaving out neighboring face polygons from the model.

In the majority of the cases the required model is solid. GDL bodies appear as shells in group definitions, so in order to achieve fast and reliable operation, the geometric correctness of the generated shells is a critical issue. Handling degenerated objects loads the GDL engine and causes the desired operation to take more time to complete. The main rule to be considered regarding the efficient use of GDL group operations can be summarized as follows: model by conforming to existing physical presence of spatial objects. In practice this can be expressed by the following guidelines:

- Avoid self-intersecting objects.
- Avoid self-touching objects (apply small gaps).
- Avoid zero-sized portions of objects (apply small thickness).

According to the above, these rules are to be followed for shells (defined by bodies), not for solids (defined by groups). (The solid produced by the script in the Group construction above is modeled properly, since the constituent shells touch each other but the shells, themselves, are geometrically correct.)

GROUP - ENDGROUP

```
GROUP "name"  
    [statement1 ... statementn]  
ENDGROUP
```

Group definition. All bodies between the corresponding GROUP - ENDGROUP statements will be part of the "name" group. Groups are not actually generated (placed), they can be used in group operations or placed explicitly using the PLACEGROUP command. Group definitions cannot be nested, but macro calls containing group definitions and PLACEGROUP commands using other groups can be included.

Group names must be unique inside the current script. Transformations, cutplanes outside the group definition have no effect on the group parts; transformations, cutplanes used inside have no effect on the bodies outside the definition. Group definitions are transparent to attribute DEFINES and SETs (pens, materials, fills); attributes defined/set before the definition and those defined/set inside the definition are all effective.

ADDGROUP

```
ADDGROUP (g_expr1, g_expr2)
ADDGROUP{2} (g_expr1, g_expr2, edgeColor, materialId, materialColor [, operationStatus])
ADDGROUP{3} (g_expr1, g_expr2, edgeColor, materialId, materialColor [, operationStatus])
```

SUBGROUP

```
SUBGROUP (g_expr1, g_expr2)
SUBGROUP{2} (g_expr1, g_expr2, edgeColor, materialId, materialColor [, operationStatus])
SUBGROUP{3} (g_expr1, g_expr2, edgeColor, materialId, materialColor [, operationStatus])
```

ISECTGROUP

```
ISECTGROUP (g_expr1, g_expr2)
ISECTGROUP{2} (g_expr1, g_expr2, edgeColor, materialId, materialColor [, operationStatus])
ISECTGROUP{3} (g_expr1, g_expr2, edgeColor, materialId, materialColor [, operationStatus])
```

g_expr1: identifier of the base group.

g_expr2: identifier of the tool group.

edgeColor: the color of the new edge when it differs from 0.

materialId: the material of the new face when it differs from 0.

materialColor: the color of the new face when the materialId is 0 and it differs from 0.

operationStatus: status control of the operation.

$operationStatus = j_1 + 2*j_2$, where each j can be 0 or 1.

j_1 : generated new edges will be invisible.

j_2 : cut polygons of the result inherit material and texture projection from the corresponding polygons of the tool group.

ISECTLINES

ISECTLINES (g_expr1, g_expr2)

Group operations: addition, subtraction, intersection, intersection lines. The return value is a new group, which can be placed using the PLACEGROUP command, stored in a variable or used as a parameter in another group operation. Group operations can be performed between previously defined groups or groups result from any other group operation. g_expr1, g_expr2 are group type expressions. Group type expressions are either group names (string expressions) or group type variables or any combination of these in operations which result in groups. Note that the operations ADDGROUP, ISECTGROUP and ISECTLINES are symmetric in their parameterization while the order of parameter matters for SUBGROUP.

PLACEGROUP

PLACEGROUP g_expr

Placing a group is the operation in which bodies are actually generated. Cutplanes and transformations are effective, the group expression is evaluated and the resulting bodies are stored in the 3D data structure.

KILLGROUP

KILLGROUP g_expr

Clears the bodies of the specified group from the memory. After a KILLGROUP operation the group becomes empty. The names of killed groups cannot be reused in the same script. Clearing is executed automatically at the end of the interpretation or when returning from macro calls. For performance reasons this command should be used when a group is no longer needed.

Example:

```

GROUP "box"
  BRICK 1, 1, 1
ENDGROUP
GROUP "sphere"
  ADDZ 1
  SPHERE 0.45
  DEL 1
ENDGROUP
GROUP "semisphere"
  ELLIPS 0.45, 0.45
ENDGROUP
GROUP "brick"
  ADD -0.35, -0.35, 0
  BRICK 0.70, 0.70, 0.35
  DEL 1
ENDGROUP
! Subtracting the "sphere" from the "box"
result_1=SUBGROUP("box", "sphere")
! Intersecting the "semisphere" and the "brick"
result_2=ISECTGROUP("semisphere", "brick")
! Adding the generated bodies
result_3=ADDGROUP(result_1, result_2)
PLACEGROUP result_3
KILLGROUP "box"
KILLGROUP "sphere"
KILLGROUP "semisphere"
KILLGROUP "brick"

```

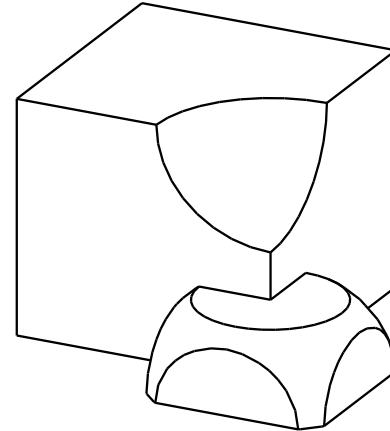

SWEEPGROUP

SWEEPGROUP (*g_expr*, *x*, *y*, *z*)

Returns a group that is created by sweeping the group parameter along the given direction. The command works for solid models only.

SWEEPGROUP{2} (*g_expr*, *x*, *y*, *z*)

The difference between SWEEPGROUP and SWEEPGROUP{2} is that in the former case the actual transformation matrix is applied again to the direction vector of the sweeping operation with respect to the current coordinate system. (In the case of SWEEPGROUP, the current transformation is applied to the direction vector twice with respect to the global coordinate system.)

SWEEPGROUP{3} (*g_expr*, *x*, *y*, *z*, *edgeColor*, *materialId*, *materialColor*, *method*)

This version adds a new method selection to SWEEPGROUP{2} and works for surface models also.

edgeColor: the color of the new edge when it differs from 0.

materialId: the material of the new face when it differs from 0.

materialColor: the color of the new face when the materialId is 0 and it differs from 0.

method: controls the ending shape of the resulting body.

0: same as SWEEPGROUP{2}, both ends come from the originating body,

1: the start comes from the originating body, the sweep end is flat

SWEEPGROUP{4} (*g_expr*, *x*, *y*, *z*, *edgeColor*, *materialId*, *materialColor*, *method*, *status*)

This version adds a new status parameter to SWEEPGROUP{3}.

status: Controls attributes of the result.

$status = 2 * j_2$, where each j can be 0 or 1.

j_2 : Keep per-polygon texture mapping parameters on the swept result (see the PGON command for details).

SWEEPGROUP{5} (*g_expr*, *x*, *y*, *z*, *edgeColor*, *materialId*, *materialColor*, *method*, *status*)

SWEEPGROUP{5} is an extension of the SWEEPGROUP{4} command with the possibility of using inline material definition, that means materials defined in GDL script locally also can be used next to materials defined in global material definitions.

Compatibility: introduced in ARCHICAD 22.

Example:

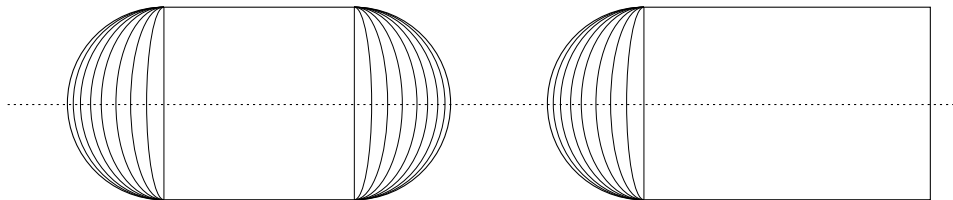

```
GROUP "the_sphere"
  SPHERE 1
ENDGROUP
PLACEGROUP SWEEPGROUP{2} ("the_sphere", 2, 0, 0)
ADDX 5
PLACEGROUP SWEEPGROUP{3} ("the_sphere", 2, 0, 0, 4, 0, 4, 1)
del 1
```

CREATEGROUPWITHMATERIAL

CREATEGROUPWITHMATERIAL (*g_expr*, *repl_directive*, *pen*, *material*)

Returns a group that is created by replacing all pens and/or materials in group *g_expr*.

g_expr: group expression identifying the base group.

repl_directive:

$\text{repl_directive} = j_1 + 2*j_2 + 4*j_3 + 8*j_4$, where each *j* can be 0 or 1.

*j*₁: replace pen,

*j*₂: replace material,

*j*₄: make edges invisible.

pen: replacement pen index.

material: replacement material index.

BINARY 3D

BINARY

BINARY *mode* [*,* *section*, *elementID*]

Special command to include inline binary objects into a GDL macro. A set of vertices, vectors, edges, polygons, bodies and materials is read from a special section of the library part file. These are transformed according to the current transformations and merged into the 3D model.

The data contained in the binary section is not editable by the user.

mode: defines pencolor and material attribute definition usage.

0: the current PEN and MATERIAL settings are in effect,

1: the current PEN and MATERIAL settings have no effect. The library part will be shown with the stored colors and material definitions. Surface appearance is constant,

2: the stored PEN and MATERIAL settings are used, non-defined materials are replaced by current settings,

3: the stored PEN and MATERIAL settings are used, non-defined materials are replaced by the stored default attributes.

section: index of the binary part, from 1 to 16.

0: you can refer simultaneously to all the existing binary parts,

1: Only these sections can be saved from within GDL, BINARY commands without the section argument will also refer to this,

2-16: can be used by third party tools.

elementID: ID of an element of this binary part. This parameter is generated during the import process.

If you open files with a different data structure (e.g., DXF or ZOOM) their 3D description will be converted into binary format.

You can save a library part in binary format from the main Library Part editing window through the Save as... command. If the Save in binary format checkbox is marked in the Save as... dialog box, the GDL text of the current library part will be replaced with a binary description.

Hint: Saving the 3D model after a 3D cutaway operation in binary format will save the truncated model. This way, you can create cut shapes.

You can only save your library part in binary format if you have already generated its 3D model.

By replacing the GDL description of your library part with a binary description you can considerably reduce the 3D conversion time of the item. On the other hand, the binary 3D description is not parametric and takes more disk space than an algorithmic GDL script.

2D SHAPES

This chapter presents the commands used for generating shapes in 2D from simple forms such as lines and arcs to complex polygons and splines, and the definition of text elements in 2D. It also covers the way binary data is handled in 2D and the projection of the shape created by a 3D script into the 2D view, thereby ensuring coherence between the 3D and 2D appearance of objects. Further commands allow users to place graphic elements into element lists created for calculations.

DRAWING ELEMENTS

HOTSPOT2

HOTSPOT2 x, y [, unID [, paramReference [, flags [, displayParam [, "customDescription"]]]]]

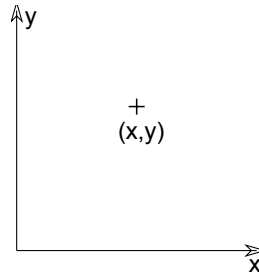

unID: the unique identifier of the hotspot in the 2D Script. Useful if you have a variable number of hotspots.

paramReference: parameter that can be edited by this hotspot using the graphical hotspot based parameter editing method.

displayParam: parameter to display in the information palette when editing the paramReference parameter. Members of arrays can be passed as well.

customDescription: custom description string of the displayed parameter in the information palette. When using this option, displayParam must be set as well (use paramReference for default).

See *Graphical Editing Using Hotspots* for information on using HOTSPOT2.

HOTLINE2

HOTLINE2 $x1, y1, x2, y2, unID$

Status line definition between two points. Status line is a line which is recognized by the intelligent cursor but it is not visible in itself. Can have a unique ID for associative dimensioning purpose.

HOTARC2

HOTARC2 $x, y, r, \text{startangle}, \text{endangle}, \text{unID}$

Status arc definition with its centerpoint at (x, y) from the angle startangle to endangle , with a radius of r . Status arc is an arc which is recognized by the intelligent cursor but it is not visible in itself. Can have a unique ID for associative dimensioning purpose.

LINE2

LINE2 $x1, y1, x2, y2$

Line definition between two points.

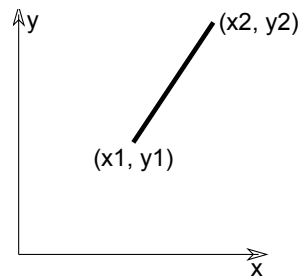

RECT2

RECT2 $x1, y1, x2, y2$

Rectangle definition by two nodes. The two points are on the diagonal of the rectangle, the sides are parallel to current X and Y axes.

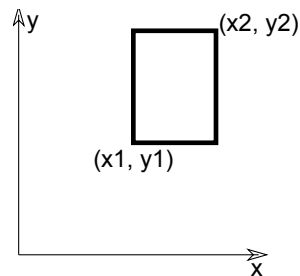

POLY2

POLY2 $n, \text{frame_fill}, x1, y1, \dots, xn, yn$

An open or closed polygon with n nodes.

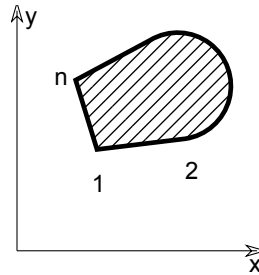

Restriction of parameters:

$$n \geq 2$$

n: number of nodes.

x1, y1, ..., xn, yn: coordinates of each nodes.

frame_fill:

frame_fill = $j_1 + 2*j_2 + 4*j_3$, where each j can be 0 or 1.

j_1 : draw contour

j_2 : draw fill

j_3 : close an open polygon

POLY2_

POLY2_ n, frame_fill, x1, y1, s1, ..., xn, yn, sn

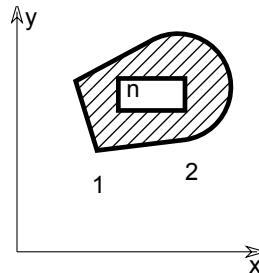

Similar to the POLY2 command, but any of the edges can be omitted. If $s_i = 0$, the edge starting from the (x_i, y_i) apex will be omitted. If $s_i = 1$, the vertex should be shown. $s_i = -1$ is used to define holes directly. You can also define arcs and segments in the polyline using additional status code values.

Restriction of parameters:

$$n \geq 2$$

n: number of nodes.

x1, y1, ..., xn, yn: coordinates of each nodes.

frame_fill:

$\text{frame_fill} = j_1 + 2*j_2 + 4*j_3 + 8*j_4 + 32*j_6 + 64*j_7$, where each j can be 0 or 1.

j_1 : draw contour,

j_2 : draw fill,

j_3 : close an open polygon,

j_4 : local fill orientation,

j_6 : fill is cut fill (default is drafting fill),

j_7 : fill is cover fill (only if $j_6 = 0$, default is drafting fill).

si: Status values:

$s_i = j_1 + 16*j_5 + 32*j_6$, where each j can be 0 or 1.

j_1 : next segment is visible,

j_5 : next segment is inner line (if 0, generic line),

j_6 : next segment is contour line (effective only if j_5 is not set),

-1: end of a contour.

Default line property for POLY2_ lines is 0 (generic line), the LINE_PROPERTY command has no effect on POLY2_ edges. Additional status codes allow you to create segments and arcs in the planar polyline using special constraints.

See the section called "Additional Status Codes" for details.

POLY2_A

POLY2_A $n, \text{frame_fill}, \text{fill_pen},$
 $x1, y1, s1, \dots, xn, yn, sn$

POLY2_B

```
POLY2_B n, frame_fill,
        fill_pen, fill_background_pen,
        x1, y1, s1, ..., xn, yn, sn
```

Advanced versions of the POLY2_ command, with additional parameters: the fill pen and the fill background pen. All other parameters are similar to those described at the POLY2_ command.

fill_pen: fill pencolor number.

fill_background_pen: fill background pencolor number.

Additional status codes allow you to create segments and arcs in the planar polyline using special constraints.

See the section called “Additional Status Codes” for details.

POLY2_B{2}

```
POLY2_B{2} n, frame_fill,
        fill_pen, fill_background_pen,
        fillOrigoX, fillOrigoY, fillAngle,
        x1, y1, s1, ..., xn, yn, sn
```

Advanced version of the POLY2_B command where the hatching origin and direction can be defined.

frame_fill:

$\text{frame_fill} = j_1 + 2*j_2 + 4*j_3 + 8*j_4 + 16*j_5 + 32*j_6 + 64*j_7$, where each j can be 0 or 1.

j_1 : draw contour

j_2 : draw fill

j_3 : close an open polygon

j_4 : local fill orientation

j_5 : global fill origin (effective only if j_4 is set)

j_6 : fill in cut category (distinctive with j_7 , drafting category if none is set)

j_7 : fill in cover category (distinctive with j_6 , drafting category if none is set).

fillOrigoX: X coordinate of the fill origin.

fillOrigoY: Y coordinate of the fill origin.

fillAngle: direction angle of fill.

Additional status codes allow you to create segments and arcs in the planar polyline using special constraints.

See the section called “Additional Status Codes” for details.

POLY2_B{3}

```
POLY2_B{3} n, frame_fill,
            fill_pen, fill_background_pen,
            fillOrigoX, fillOrigoY,
            mxx, mxy, myx, myy, x1, y1, s1, ..., xn, yn, sn
```

Advanced version of the POLY2_B command, where the orientation of the fill can be defined using a matrix.

frame_fill:

frame_fill = $j_1 + 2*j_2 + 4*j_3 + 8*j_4 + 16*j_5 + 32*j_6 + 64*j_7 + 128*j_8$, where each j can be 0 or 1.

j_1 - j_7 : similar as for previous POLY2_ commands,

j_8 : use sloped fill.

mxx, mxy, myx, myy: if j_8 is set, this matrix defines the orientation of the fill.

Additional status codes allow you to create segments and arcs in the planar polyline using special constraints.

See the section called “Additional Status Codes” for details.

POLY2_B{4}

```
POLY2_B{4} n, frame_fill,
            fill_pen, fill_background_pen,
            fillOrigoX, fillOrigoY,
            mxx, mxy, myx, myy,
            gradientInnerRadius,
            x1, y1, s1, ..., xn, yn, sn
```

Advanced version of POLY2_B{3}, where the inner radius of radial gradient fill can be set.

gradientInnerRadius: inner radius of the gradient in case radial gradient fill is selected for the polygon.

POLY2_B{5}

```
POLY2_B{5} n, frame_fill, fillcategory, distortion_flags,
            fill_pen, fill_background_pen,
            fillOrigoX, fillOrigoY,
            mxx, mxy, myx, myy,
            gradientInnerRadius,
            x1, y1, s1, ..., xn, yn, sn
```

Advanced version of POLY2_B{4}, where fill distortion can be controlled in an enhanced way.

frame_fill:

$frame_fill = j_1 + 2*j_2 + 4*j_3$, where each j can be 0 or 1.

j_1 : draw contour
 j_2 : draw fill
 j_3 : close an open polygon.

fillcategory:

0: Draft,
 1: Cut,
 2: Cover.

distortion_flags:

$distortion_flags = j_1 + 2*j_2 + 4*j_3 + 8*j_4 + 16*j_5 + 32*j_6 + 64*j_7$, where each j can be 0 or 1.

The valid value for `distortion_flags` is between 0 and 127. Don't use value out of this range.

j_1 : the fill origin's X coordinate is the global origin's X coordinate, meaningful only when j_4 is set. The fillOrigo is the origin (0,0) projected on the line of the (mxx, mxy) vector,
 j_2 : the fill origin's Y coordinate is the global origin's Y coordinate, meaningful only when j_4 is set,
 j_3 : create circular distortion using the innerRadius parameter,
 j_4 : use local orientation, use the distortion matrix (mij parameters),
 j_5 : (effective for symbol fills only) reset the pattern's X size to the defined X vector's length (mxx, mxy),
 j_6 : (effective for symbol fills only) reset the pattern's Y size to the defined Y vector's length (myx, myy),
 j_7 : (effective for symbol fills only) keep proportion of symbol fill pattern; effective only if one of j_5 and j_6 is set.

innerRadius: radius for circular fill distortion; the origin of the base circle will be placed on the Y fill axis in the (0, -innerRadius) position.

POLY2_B{6}

POLY2_B{6} n, frame_fill, fillcategory, distortion_flags,
 fill_pen, fill_background_pen,
 fillOrigoX, fillOrigoY,
 mxx, mxy, myx, myy,
 gradientInnerRadius,
 x1, y1, s1, pen1, linetype1, ..., xn, yn, sn, penn, linetypen

Advanced version of POLY2_B{5}, where contour attributes (pen and linetype) can be controlled individually for each contour segment.

peni: pen index of the contour line starting from control point i.

linetypei: line type index of the contour line starting from control point i.

Compatibility: introduced in ARCHICAD 21.

ARC2

ARC2 x , y , r , α , β

An arc with its centerpoint at (x, y) from the angle α to β , with a radius of r .

Alpha and beta are in degrees.

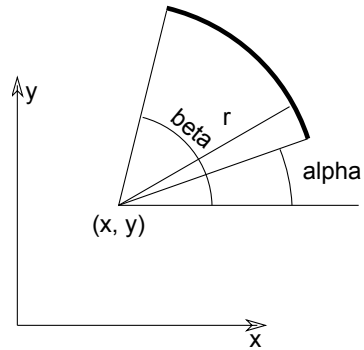

CIRCLE2

CIRCLE2 x , y , r

A circle with its center at (x, y) , with a radius of r .

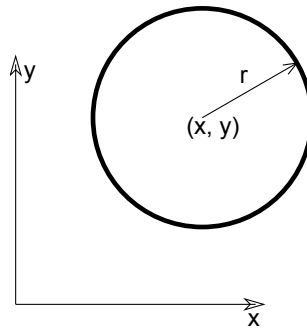

SPLINE2

SPLINE2 *n*, *status*, *x1*, *y1*,
angle1, ..., *xn*, *yn*, *anglen*

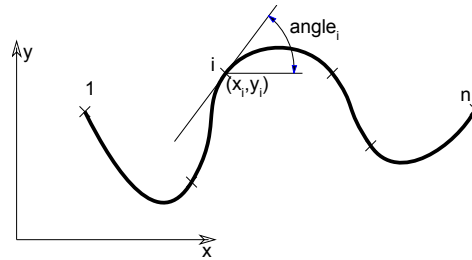

Spline, with *n* control points. The tangent of the spline in the control point (*x_i*, *y_i*) is defined by *angle_i*, the angle with the x axis in degrees.

Restriction of parameters:

n >= 2

si: Status values:

0: default,

1: closed spline; the last and first nodes of the spline will become connected, thus closing the spline,

2: automatically smoothed spline; the angle parameter value of the nodes between the first and the last node is not used when generating the spline. An internal autosmoothing algorithm is used.

Example 1:

```
SPLINE2 5, 2,
0, 0, 60,
1, 2, 30,
1.5, 1.5, -30,
3, 4, 45,
4, 3, -45
```

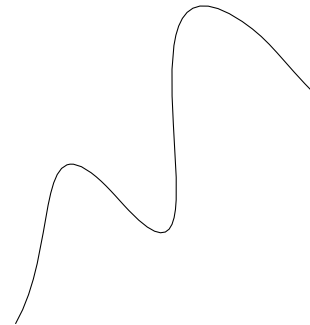

Example 2:

```

n = 5
FOR i = 1 TO n
  SPLINE2 4, 0,
    0.0, 2.0, 135.0,
    -1.0, 1.8, 240.0,
    -1.0, 1.0, 290.0,
    0.0, 0.0, 45.0
  MUL2 -1.0, 1.0
  SPLINE2 4, 0,
    0.0, 2.0, 135.0,
    -1.0, 1.8, 240.0,
    -1.0, 1.0, 290.0,
    0.0, 0.0, 45.0
  DEL 1
  SPLINE2 4, 0,
    0.0, 2.0, 100.0,
    0.0, 2.5, 0.0,
    0.0, 2.4, 270.0,
    0.0, 2.0, 270.0
  ADD2 2.5, 0
NEXT i

```

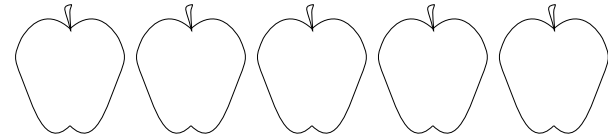

SPLINE2A

```

SPLINE2A n, status, x1, y1, angle1, length_previous1, length_next1,
  ...
  xn, yn, anglen, length_previousn,
  length_nextn

```

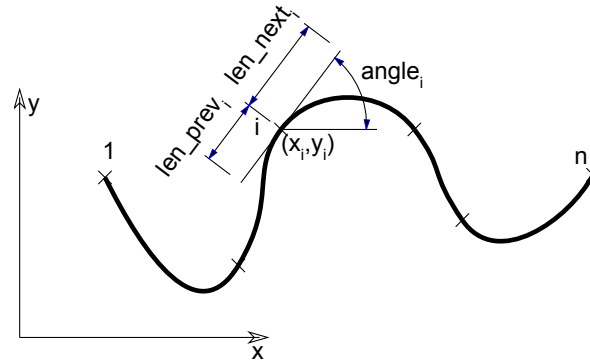

Extension of the SPLINE2 command (Bézier spline), used mainly in automatic 2D script generation because of its complexity. For more details, see “Lines / Drawing Splines” in the Documentation chapter of the ARCHICAD Help.

si: Status values:

- 0: default,
- 1: closed spline; the last and first nodes of the spline will become connected, thus closing the spline,
- 2: automatically smoothed spline; the angle, length_previous_i and length_next_i parameter values of the nodes between the first and the last node are not used when generating the spline. An internal autosmoothing algorithm is used.

xi, yi: control point coordinates.

length_previous_i, length_next_i: tangent lengths for the previous and the next control points.

angle_i: tangent direction angle.

Example:

```
SPLINE2A 9, 2,
    0.0, 0.0, 0.0, 0.0, 0.0,
    0.7, 1.5, 15, 0.9, 1.0,
    1.9, 0.8, 72, 0.8, 0.3,
    1.9, 1.8, 100, 0.3, 0.4,
    1.8, 3.1, 85, 0.4, 0.5,
    2.4, 4.1, 352, 0.4, 0.4,
    3.5, 3.3, 338, 0.4, 0.4,
    4.7, 3.7, 36, 0.4, 0.8,
    6.0, 4.6, 0, 0.0, 0.0
```

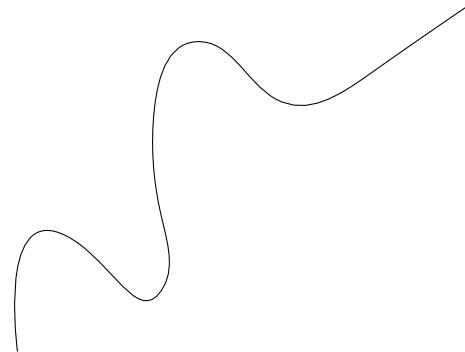

PICTURE2

PICTURE2 expression, a, b, mask

PICTURE2{2}

PICTURE2{2} expression, a, b, mask

Can be used in 2D similarly to the PICTURE command in 3D. Unlike in 3D, the mask values have no effect on 2D pictures.

A string type expression means a file name, a numerical expression means an index of a picture stored in the library part. A 0 index is a special value, it refers to the preview picture of the library part. For PICTURE2{2} mask = 1 means that exact white colored pixels are transparent.

Other pictures can only be stored in library parts when saving the project or selected elements containing pictures as GDL objects.

TEXT ELEMENT

TEXT2

TEXT2 x, y, expression

The value of the calculated numerical or string type expression is written in the set style at the x, y coordinates.

See also the [SET] STYLE command and the DEFINE STYLE command.

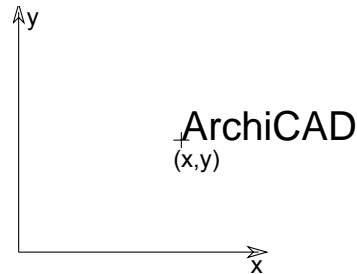

RICHTEXT2

RICHTEXT2 *x*, *y*, *textblock_name*

Place a previously defined TEXTBLOCK.

For more details, *see the TEXTBLOCK command.*

x, **y**: X-Y coordinates of the richtext location.

textblock_name: the name of a previously defined TEXTBLOCK

BINARY 2D

FRAGMENT2

FRAGMENT2 *fragment_index*, *use_current_attributes_flag*

FRAGMENT2 ALL, *use_current_attributes_flag*

The fragment with the given index is inserted into the 2D Full View with the current transformations. If ALL is specified, all fragments are inserted.

use_current_attributes_flag: defines whether or not the current attributes will be used.

0: the fragment appears with the color, line type and fill type defined for it,

1: the current settings of the script are used instead of the color, line type and fill type of the fragment.

3D PROJECTIONS IN 2D

PROJECT2

PROJECT2 *projection_code*, *angle*, *method*

PROJECT2{2}

PROJECT2{2} projection_code, angle, method [, backgroundColor, fillOrigoX, fillOrigoY, filldirection]

Creates a projection of the 3D script in the same library part and adds the generated lines to the 2D parametric symbol. The 2nd version PROJECT2{2}, together with a previous [SET] FILL command, allows the user to control the fill background, origin and direction of the resulting drawing from the 2D script. The SET FILL 0 shortcut to get an empty fill does not work in this case, you need to reference an actual empty fill.

projection_code: the type of projection.

- 3: Top view,
- 4: Side view,
- 5: Side view 2,
- 6: Frontal axonometry,
- 7: Isometric axonometry,
- 8: Monometric axonometry,
- 9: Dimetric axonometry,
- 3: Bottom view,
- 6: Frontal bottom view,
- 7: Isometric bottom view,
- 8: Monometric bottom view,
- 9: Dimetric bottom view.

angle: the azimuth angle set in the 3D Projection Settings dialog box.

method: the chosen imaging method. If invalid or none is set, the default is hidden lines (2).

- 1: wireframe,
- 2: hidden lines (analytic),
- 3: shading,
- 16: addition modifier: draws vectorial hatches (effective only in hidden line and shaded mode),
- 32: addition modifier: use current attributes instead of attributes from 3D (effective only in shading mode),
- 64: addition modifier: local fill orientation (effective only in shading mode),
- 128: addition modifier: lines are all inner lines (effective only together with 32). Default is generic,
- 256: addition modifier: lines are all contour lines (effective only together with 32, if 128 is not set). Default is generic,
- 512: addition modifier: fills are all cut (effective only together with 32). Default is drafting fills,
- 1024: addition modifier: fills are all cover (effective only together with 32, if 512 is not set). Default is drafting fills.

BackgroundColor: background color of the fill.

fillOrigoX: X coordinate of the fill origin.

fillOrigoY: Y coordinate of the fill origin.

filldirection: direction angle of fill.

Note: the [SET] FILL command is effective for PROJECT2{2}

Example:

2D

```
PROJECT2 3, 270, 2
```

```
LINE_TYPE "DASHED"  
ARC2 0, 0, A-B/3, 0, E
```

```
E = 270  
A = 1  
B = 0.2
```

```
ROT2 E  
ADD2 A-B/3, 0  
LINE2 0, 0, -0.05, -0.1  
LINE2 0, 0, 0.05, -0.1
```

```
DEL 2
```

3D

```
n = 12  
E = 270  
D = 0.2  
A = 1  
B = 0.2
```

```
FOR i=1 TO n  
  prism 4, D,  
    -B/3, -B/2,  
    -B/3, B/2,  
    A-B/3, B/8,  
    A-B/3, -B/8  
  ADDZ D  
  ROTz E/(n-1)  
NEXT i
```

```
DEL n*2
```

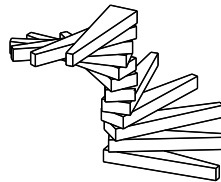
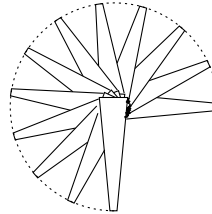

PROJECT2{3}

PROJECT2{3} projection_code, angle, method, parts [, backgroundColor, fillOrigoX, fillOrigoY, filldirection][[,] PARAMETERS name1=value1, ..., namen=valuen]

Creates a projection of the 3D script in the same library part and adds the generated lines to the 2D parametric symbol. The third version, PROJECT2{3}, adds the possibility to define which parts of the projected model are required and to control separately the attributes of the cut and view part, including the line type. You can also generate the projection with actual parameters set in the command.

method: the chosen imaging method. If invalid or none is set, the default is hidden lines (2).

- 1: wireframe,
- 2: hidden lines (analytic),
- 3: shading,
- 16: addition modifier: draws vectorial hatches (effective only in hidden line and shaded mode),
- 32: addition modifier: use current attributes instead of attributes from 3D (effective only in shading mode),
- 64: addition modifier: local fill orientation (effective only in shading mode),
- 128: addition modifier: lines are all inner lines (effective only together with 32). Default is generic.
- 256: addition modifier: lines are all contour lines (effective only together with 32, if 128 is not set). Default is generic.
- 512: addition modifier: fills are all cut (effective only together with 32). Default is drafting fills.
- 1024: addition modifier: fills are all cover (effective only together with 32, if 512 is not set). Default is drafting fills.
- 2048: addition modifier: modifiers 16, 32, 64, 128, 256, 512, 1024 and fill attribute parameters are effective only for the view part of the projection. By default they are effective for all parts.
- 4096: addition modifier: modifiers 16, 32, 64, 128, 256, 512, 1024 and fill attribute parameters are effective only for the cut part of the projection. By default they are effective for all parts.
- 8192: addition modifier: cut fills are slanted.
- 16384: addition modifier: enables transparency for transparent surfaces. Note that transparency in this case means full transparency for surfaces with transmittance greater than 50, everything else is non-transparent.

Known limitation: lines of the cut part cannot be treated separately, only all lines together can be set to be inner or contour.

Compatibility note: up to ARCHICAD 19, cut polygons were generated with attributes defined by the SECT_FILL command or the SECT_ATTRS command in the 3D script. From ARCHICAD 20 the attributes of the cut polygons are defined by the cover fill of the outer surfaces (in case the addition modifier 32 is not set).

parts: defines the parts to generate. The 1+2+4+8+16+32 value means all parts.

parts = $j_1 + 2*j_2 + 4*j_3 + 8*j_4 + 16*j_5 + 32*j_6$, where each j can be 0 or 1.

The $j_1, j_2, j_3, j_4, j_5, j_6$ numbers represent whether the corresponding parts of the projected model are present (1) or omitted (0):

- j₁: cut polygons (effective only in shading mode),
- j₂: cut polygon edges,
- j₃: view polygons,
- j₄: view polygon edges,
- j₅: project 3D hotspots as static 2D hotspots,
- j₆: project 3D hotlines and hotarcs (including related 3D hotspots converted to static 2D hotspots).

PROJECT2{4}

```

PROJECT2{4} projection_code, angle,
  useTransparency, statusParts,
  numCutplanes,
  cutplaneHeight1, ..., cutplaneHeightn,

  method1, parts1,
  cutFillIndex1,
  cutFillFgPen1, cutFillBgPen1,
  cutFillOrigoX1, cutFillOrigoY1, cutFillDirection1,
  cutLinePen1, cutLineType1,
  projectedFillIndex1,
  projectedFillFgPen1, projectedFillBgPen1,
  projectedFillOrigoX1, projectedFillOrigoY1,
  projectedFillDirection1,
  projectedLinePen1, projectedLineType1,
  ...
  method(numCutplanes+1), parts(numCutplanes+1),
  cutFillIndex(numCutplanes+1),
  cutFillFgPen(numCutplanes+1), cutFillBgPen(numCutplanes+1),
  cutFillOrigoX(numCutplanes+1), cutFillOrigoY(numCutplanes+1),
  cutFillDirection(numCutplanes+1),
  cutLinePen(numCutplanes+1), cutLineType(numCutplanes+1),
  projectedFillIndex(numCutplanes+1),
  projectedFillFgPen(numCutplanes+1), projectedFillBgPen(numCutplanes+1),
  projectedFillOrigoX(numCutplanes+1), projectedFillOrigoY(numCutplanes+1),
  projectedFillDirection(numCutplanes+1),
  projectedLinePen(numCutplanes+1), projectedLineType(numCutplanes+1)

```

Compatibility: introduced in ARCHICAD 20.

Creates a projection of the 3D script in the same library part and adds the generated lines to the 2D parametric symbol. The fourth version, PROJECT2{4}, adds the possibility to define multiple cutting planes parallel to the X-Y plane, and to control the attributes of the cut and projected parts of the slices, including the line type, pens and fills. The number of cutplanes can be zero, creating exactly one uncut slice ($\text{numCutplanes}+1$).

useTransparency: can be 0 (no transparency) or positive integer (1: transparency enabled).

statusParts: defines the status parts to generate (hotlines, hotspots, hotarcs). The 1+2 value means all parts. Setting is applied for all slices.

$\text{statusParts} = j_1 + 2*j_2$, where each j can be 0 or 1.

The j_1, j_2 numbers represent whether the corresponding status parts of the projected model are present (1) or omitted (0):

j_1 : project 3D hotspots as static 2D hotspots,

j_2 : project 3D hotlines and hotarcs (including related 3D hotspots converted to static 2D hotspots).

numCutplanes: the number of defined cutplanes. Can be zero, but preferably more.

cutplaneHeighti: the position of each individually defined cutplane. Measured as length perpendicularly from the X-Y plane of the object.

method: the chosen imaging method. If invalid or none is set, the default is hidden lines (2).

0: the current slice is not part of the projection,

1: wireframe,

2: hidden lines (analytic),

3: shading,

4: hidden lines with polygon: the polygon does not eliminate any polygon or line belonging to parts created with shading method, but will cover/eliminate polygons and lines belonging to other wireframe/hidden line parts. Set it to Air Space for best result. Such exploded polygons will behave in 2D according to slice order (will cover, but not eliminate shaded parts).

16: addition modifier: draws vectorial hatches (effective only in hidden line modes and shaded mode),

32: addition modifier: use current attributes instead of attributes from 3D (effective only in shading mode and hidden line with polygon mode),

64: addition modifier: local fill orientation (effective only in shading mode and hidden line with polygon mode),

128: addition modifier: lines are all inner lines (effective only together with 32). Default is generic.

256: addition modifier: lines are all contour lines (effective only together with 32, if 128 is not set). Default is generic.

512: addition modifier: fills are all cut (effective only together with 32). Default is drafting fills.

1024: addition modifier: fills are all cover (effective only together with 32, if 512 is not set). Default is drafting fills.

2048: addition modifier: modifiers 16, 32, 64, 128, 256, 512, 1024 and fill attribute parameters are effective only for the view part of the projection. By default they are effective for all parts.

4096: addition modifier: modifiers 16, 32, 64, 128, 256, 512, 1024 and fill attribute parameters are effective only for the cut part of the projection. By default they are effective for all parts.

8192: addition modifier: cut fills are slanted.

partsi: defines the parts to generate. The 1+2+4+8+64 value means all parts.

$\text{partsi} = j_1 + 2*j_2 + 4*j_3 + 8*j_4 + 64*j_7$, where each j can be 0 or 1.

The j_1, j_2, j_3, j_4, j_7 numbers represent whether the corresponding parts of the projected model are present (1) or omitted (0):

j_1 : cut polygons (effective only in shading mode),

j_2 : cut polygon edges,

j_3 : view polygons,

j_4 : view polygon edges,

j_7 : project pointclouds.

cutFillIndexi: fill type index of the cut part of the current slice.

cutFillFgPeni: fill pen of the cut part of the current slice.

cutFillBgPeni: fill background pen of the cut part of the current slice.

cutFillOrigoXi: X coordinate of the cut fill origin of the current slice.

cutFillOrigoYi: Y coordinate of the cut fill origin of the current slice.

cutFillDirectioni: direction angle of the cut fill of the current slice.

cutLinePeni: pen index of cut lines of the current slice.

cutLineTypei: line type of cut lines of the current slice.

projectedFillIndexi: fill type index of the projected part of the current slice.

projectedFillFgPeni: fill pen of the projected part of the current slice.

projectedFillBgPeni: fill background pen of the projected part of the current slice.

projectedFillOrigoXi: X coordinate of the projected fill origin of the current slice.

projectedFillOrigoYi: Y coordinate of the projected fill origin of the current slice.

projectedFillDirectioni: direction angle of the projected fill of the current slice.

projectedLinePeni: pen index of projected lines of the current slice.

projectedLineTypei: line type of projected lines of the current slice.

DRAWINGS IN THE LIST

These commands only take effect when a list of elements is created.

When the library part is a special property type library part and is in some way associated to a library part (Object, Door, Window or Light) placed on the floor plan, including the following commands in its 2D script will refer to the 2D and 3D part of that library part. This is a virtual reference that is resolved during the listing process, using the 2D or 3D script of the currently listed element.

DRAWING2

DRAWING2 [expression]

Depending on the value of the expression, creates a drawing of the library part (expression = 0, default) or the label of the element (expression = 1) associated with the Property Object containing this command.

DRAWING3

DRAWING3 projection_code, angle, method

DRAWING3{2}

DRAWING3{2} projection_code, angle, method [, backgroundColor, fillOrigoX, fillOrigoY, filldirection]

Similarly to PROJECT2, creates a projection of the 3D script of the library part associated with the property library part containing this command. All parameters are similar to those of PROJECT2 and PROJECT2{2}.

method: New method flags in DRAWING3{2}

- 3: shading,
- 32: use current attributes instead of attributes from 3D,
- 64: local fill orientation.

DRAWING3{3}

DRAWING3{3} projection_code, angle, method, parts [, backgroundColor, fillOrigoX, fillOrigoY, filldirection][[,] PARAMETERS name1=value1, ..., namen=valuen]

Similarly to PROJECT2, creates a projection of the 3D script of the library part associated with the property library part containing this command. All parameters are similar to those of PROJECT2, PROJECT2{2} and PROJECT2{3}.

method: New method flags in DRAWING3{3}

- 2048: addition modifier: modifiers 16, 32, 64, 128, 256, 512, 1024 and fill attribute parameters are effective only for the view part of the projection. By default they are effective for all parts,

4096: addition modifier: modifiers 16, 32, 64, 128, 256, 512, 1024 and fill attribute parameters are effective only for the cut part of the projection. By default they are effective for all parts,

8192: addition modifier: cut fills are slanted.

16384: addition modifier: enables transparency for transparent surfaces. Note that transparency in this case means full transparency for surfaces with transmittance greater than 50, everything else is non-transparent.

GRAPHICAL EDITING USING HOTSPOTS

Hotspot-based interactive graphical editing of length and angle type GDL parameters.

```
HOTSPOT x, y, z [, unID [, paramReference [, flags [, displayParam [, "customDescription"]]]]]]
HOTSPOT2 x, y [, unID [, paramReference [, flags [, displayParam [, "customDescription"]]]]]]
```

unID: unique identifier, which must be unique among the hotspots defined in the library part.

paramReference: parameter that can be edited by this hotspot using the graphical hotspot based parameter editing method.

displayParam: parameter to display in the information palette when editing the paramReference parameter. Members of arrays can be passed as well.

customDescription: custom description string for the displayed parameter in the information palette. When using this option, displayParam must be set as well (use paramReference for default). The value set for the moving type hotspot will be displayed only. It is recommended to set the same description for all moving hotspots having the same base hotspot.

Examples of valid arguments:

D, Arr[5], Arr[2*I+3][D+1], etc.

flags: hotspot's type + hotspot's attribute:

type:

- 1: length type editing, base hotspot,
- 2: length type editing, moving hotspot,
- 3: length type editing, reference hotspot (always hidden),
- 4: angle type editing, base hotspot,
- 5: angle type editing, moving hotspot,
- 6: angle type editing, center of angle (always hidden),
- 7: angle type editing, reference hotspot (always hidden).

attribute: Can be zero or:

attribute = $128*j_8 + 256*j_9 + 512*j_{10} + 1024*j_{11}$, where each j can be 0 or 1.

j_8 : hide hotspot (meaningful for types: 1,2,4,5),

j_9 : editable base hotspot (for types: 1,4),

j_{10} : reverse the angle in 2D (for type 6),

j_{11} : use paramReference value as meters in paper space.

To edit a length type parameter, three hotspots must be defined with types 1, 2 and 3. The positive direction of the editing line is given by the vector from the reference hotspot to the base hotspot. The moving hotspot must be placed along this line at a distance determined by the associated parameter's value, measured from the base hotspot.

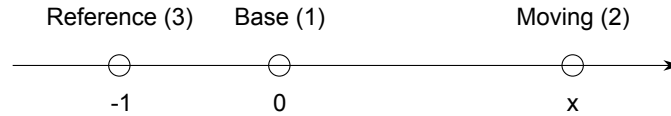

To edit an angle type parameter, in 3D four hotspots must be defined with types 4, 5, 6 and 7. The plane of the angle is perpendicular to the vector that goes from the center hotspot to the reference hotspot. The positive direction in measuring the angle is counter-clockwise if we look at the plane from the reference hotspot. In 2D the plane is already given, so the reference hotspot is ignored, and the positive direction of measuring the angle is by default counter-clockwise. This can be changed to clockwise by setting the 512 attribute flag for the center hotspot (type 6). To be consistent, the vectors from the center hotspot to the moving and the base hotspots must be perpendicular to the vector from the center to the reference hotspot. The moving hotspot must be placed at an angle determined by the associated parameter measured from the base hotspot around the center hotspot.

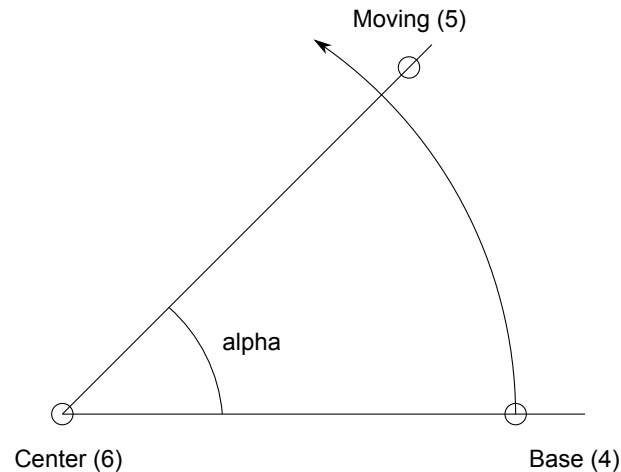

If several sets of hotspots are defined to edit the same parameter, hotspots are grouped together in the order of the execution of the hotspot commands. If the editable attribute is set for a base hotspot, the user can also edit the parameter by dragging the base hotspot. Since the base hotspot is supposed to be fixed in the object's coordinate frame (i.e. its location must be independent of the parameter that is attached to it), the whole object is dragged or rotated along with the base point. (As the parameter's value is changing, the moving hotspot will not change its location.)

Two length type sets of hotspots can be combined to allow editing of two parameters with only one dragging. If two are combined, the motion of the hotspot is no longer constrained to a line but to the plane determined by the two lines of each set of length editing hotspots. In 3D, the combination of three sets of length editing hotspots allows the hotspot to be placed anywhere in space. The two lines must not be parallel to each other, and the three lines must not be on the same plane. A combined parameter editing operation is started if, at the location of the picked point, there are two editable hotspots (moving or editable base) with different associated parameters. If parameters are designed for combined editing, the base and reference hotspots are not fixed in the object's coordinate frame, but must move as the other parameter's value changes. See illustration and example 2.

```
! sideX, sideY parameters
RECT2 0, 0, A, B
RECT2 0, 0, sideX, sideY
HOTSPOT2 sideX, 0, 1, sideY, 1
HOTSPOT2 sideX, -0.1, 2, sideY, 3
HOTSPOT2 sideX, sideY, 3, sideY, 2
HOTSPOT2 0, sideY, 4, sideX, 1
HOTSPOT2 -0.1, sideY, 5, sideX, 3
HOTSPOT2 sideX, sideY, 6, sideX, 2
```

Example 3: Simple length type editing with 1 parameter

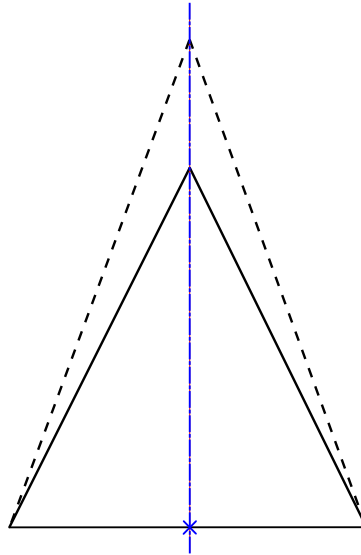

```
!2D SCRIPT:
HOTSPOT2 -1, 0, 1
HOTSPOT2 1, 0, 2
HOTSPOT2 0, 0, 3, corner_y, 1+128
HOTSPOT2 0, -1, 4, corner_y, 3
HOTSPOT2 0, corner_y, 5, corner_y, 2
LINE2 -1, 0, 1, 0
LINE2 -1, 0, 0, corner_y
LINE2 1, 0, 0, corner_y
!3D SCRIPT:
HOTSPOT -1, 0, 0, 1
HOTSPOT -1, 0, 0.5, 2
HOTSPOT 1, 0, 0, 3
HOTSPOT 1, 0, 0.5, 4
HOTSPOT 0, 0, 0, 5, corner_y, 1+128
HOTSPOT 0, -1, 0, 6, corner_y, 3
HOTSPOT 0, corner_y, 0, 7, corner_y, 2
HOTSPOT 0, 0, 0.5, 8, corner_y, 1+128
HOTSPOT 0, -1, 0.5, 9, corner_y, 3
HOTSPOT 0, corner_y, 0.5, 10, corner_y, 2

PRISM_ 4, 0.5,
    -1, 0, 15,
    1, 0, 15,
    0, corner_y, 15,
    -1, 0, -1
```

Example 4: Combined length type editing with 2 parameters:

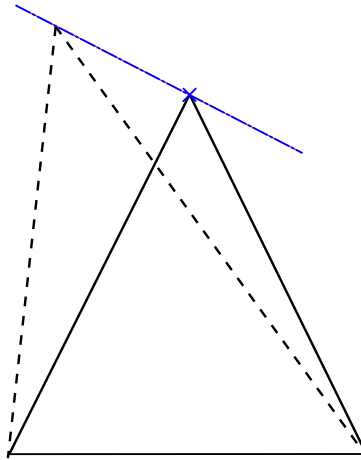

```
!2D SCRIPT:
HOTSPOT2 -1, 0, 1
HOTSPOT2 1, 0, 2
HOTSPOT2 corner_x, 0, 3, corner_y, 1+128
HOTSPOT2 corner_x, -1, 4, corner_y, 3
HOTSPOT2 corner_x, corner_y, 5, corner_y, 2
HOTSPOT2 0, corner_y, 6, corner_x, 1+128
HOTSPOT2 -1, corner_y, 7, corner_x, 3
HOTSPOT2 corner_x, corner_y, 8, corner_x, 2
LINE2 -1, 0, 1, 0
LINE2 -1, 0, corner_x, corner_y
LINE2 1, 0, corner_x, corner_y
```

```
!3D SCRIPT:
HOTSPOT -1, 0, 0, 1
HOTSPOT -1, 0, 0.5, 2
HOTSPOT 1, 0, 0, 3
HOTSPOT 1, 0, 0.5, 4
HOTSPOT corner_x, 0, 0, 5, corner_y, 1+128
HOTSPOT corner_x, -1, 0, 6, corner_y, 3
HOTSPOT corner_x, corner_y, 0, 7, corner_y, 2
HOTSPOT 0, corner_y, 0, 8, corner_x, 1+128
HOTSPOT -1, corner_y, 0, 9, corner_x, 3
HOTSPOT corner_x, corner_y, 0, 10, corner_x, 2
HOTSPOT corner_x, 0, 0.5, 11, corner_y, 1+128
HOTSPOT corner_x, -1, 0.5, 12, corner_y, 3
HOTSPOT corner_x, corner_y, 0.5, 13, corner_y, 2
HOTSPOT 0, corner_y, 0.5, 14, corner_x, 1+128
HOTSPOT -1, corner_y, 0.5, 15, corner_x, 3
HOTSPOT corner_x, corner_y, 0.5, 16, corner_x, 2
PRISM 4, 0.5,
    -1, 0, 15,
    1, 0, 15,
    corner_x, corner_y, 15,
    -1, 0, -1
```

STATUS CODES

Status codes introduced in the following pages allow users to create segments and arcs in planar polylines using special constraints.

Planar polylines with status codes at nodes are the basis of many GDL elements: POLY2_, POLY2_A, POLY2_B, POLY2_B{2}, POLY2_B{3}, POLY2_B{4}, POLY2_B{5}, POLY_, PLANE_, PRISM_, CPRISM_, BPRISM_, FPRISM_, HPRISM_, SPRISM_, SLAB_, CSLAB_, CROOF_, EXTRUDE, PYRAMID, REVOLVE, SWEEP, TUBE, TUBEA

Status codes allow you:

- to control the visibility of planar polyline edges
- to define holes in the polyline
- to control the visibility of side edges and surfaces
- to create segments and arcs in the polyline

STATUS CODE SYNTAX

si: The si number is a binary integer (between 0 and 127) or -1.

$si = j_1 + 2*j_2 + 4*j_3 + 8*j_4 + 64*j_7$ [+ a_code] , where each j can be 0 or 1.

The j1, j2, j3, j4 numbers represent whether the vertices and the sides are present (1) or omitted (0):

j1: lower horizontal edge,

j2: vertical edge,

j3: upper horizontal edge,

j4: side face,

j7: special additional status value effective only when j2=1 and controls the viewpoint dependent visibility of the current vertical edge,















a_code: additional status code (optional), which allows you to create segments and arcs in the polyline,

j2=0: the vertical edge is always invisible

j2=1 and j7=1: the vertical edge is only visible when it is a contour observed from the current direction of view

j2=1 and j7=0: the vertical edge is always visible

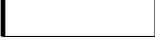
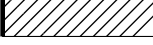
Possible status values (the heavy lines denote visible edges):

	invisible surface		visible surface
0		8	
1		9	
2		10	
3		11	
4		12	
5		13	
6		14	
7		15	

$si=-1$ is used to define holes directly into the prism. It marks the end of the contour and the beginning of a hole inside of the contour. It is also used to indicate the end of one hole's contour and the beginning of another. Coordinates before that value must be identical to the coordinates of the first point of the contour/hole. If you have used the -1 mask value, the last mask value in the parameter list must be -1, marking the end of the last hole.

The holes must be disjoint and internal intersections are forbidden in the polygon for a correct shading/rendering result.

ADDITIONAL STATUS CODES

The following additional status codes allow you to create segments and arcs in the polyline using special constraints. They refer to the next segment or arc. Original status code(s) are only effective where they are specified (a "+" is included after the additional code).

Note

Resolution of arcs is controlled by directives described in the section called “Directives for 3D and 2D Scripts”. In case of the POLY2_ command, if the resolution is greater than 8, it generates real arcs; otherwise all generated arcs will be segmented.

Previous part of the polyline: current position and tangent is defined

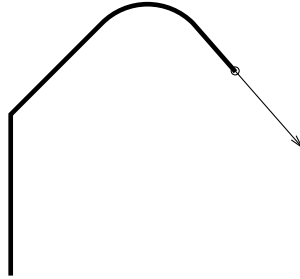

Segment by absolute endpoint

x, y, s

where $0 < s < 100$

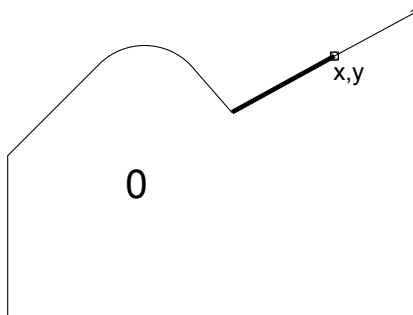

Segment by relative endpoint

$dx, dy, 100+s,$

where $0 < s < 100$

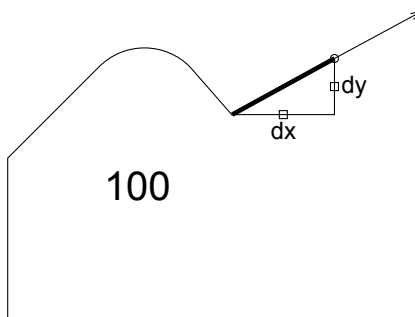

Segment by length and direction

$l, a, 200+s,$

where $0 < s < 100$

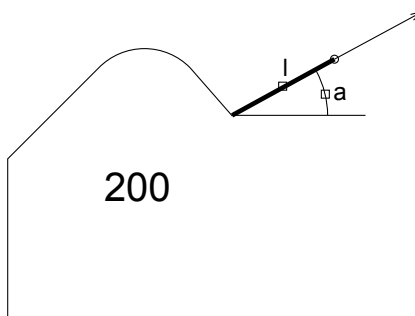

Tangential segment by length

$l, 0, 300+s,$

where $0 < s < 100$

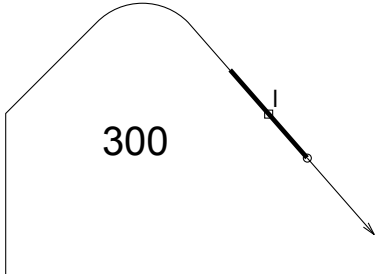

Set start point

$x1, y1, 600,$

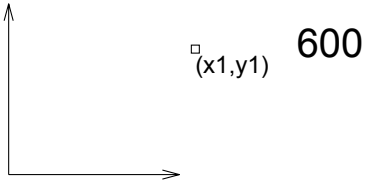

Close polyline

$0, 0, 700,$

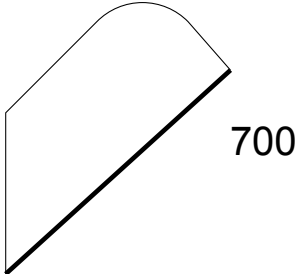

Set tangent

$ex, ey, 800,$

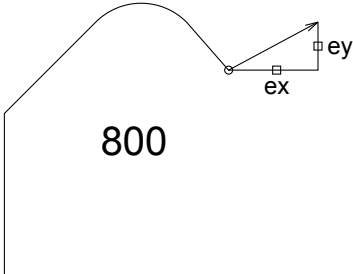

Set centerpoint

$x_0, y_0, 900,$

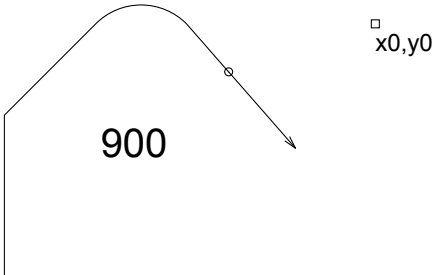

Tangential arc to endpoint

$x, y, 1000+s,$

where $0 < s < 100$

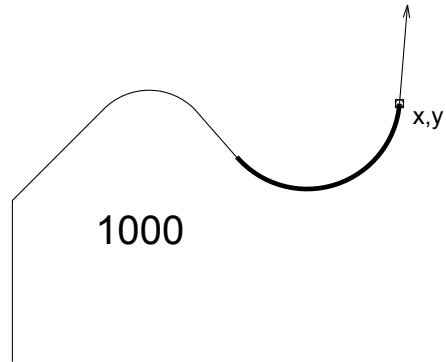

Tangential arc by radius and angle

$r, a, 2000+s,$

where $0 < s < 100$

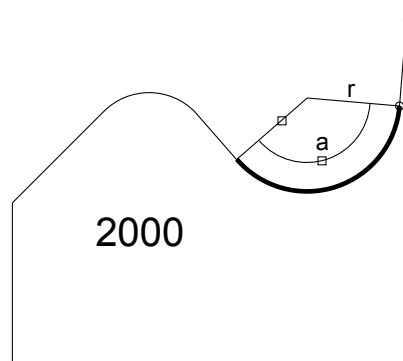

Arc using centerpoint and point on the final radius

$x, y, 3000+s,$

where $0 < s < 100$

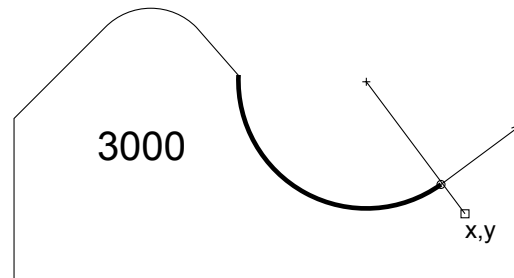

Arc using centerpoint and angle

$0, a, 4000+s,$
where $0 < s < 100$

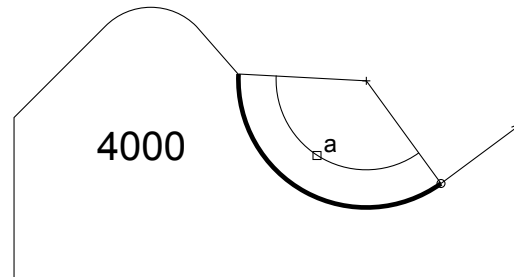

Full circle using centerpoint and radius

$r, 360, 4000+s,$
where $0 < s < 100$

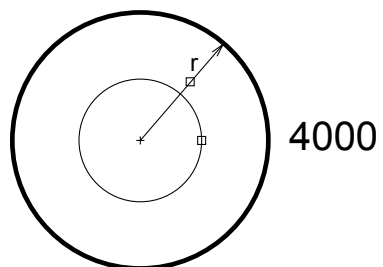

In this case the s status refers to the whole circle.

All angle values are in degrees. Omitted coordinates marked by 0 (for codes 300, 700, 4000) can have any value.

Example 1:

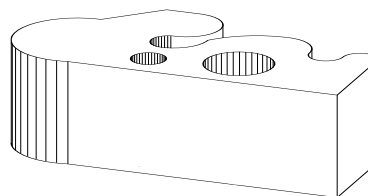
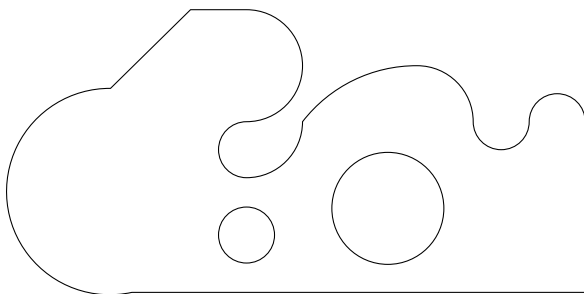

```
EXTRUDE 21, 0, 0, 3, 1+2+4+16+32,
0, 0, 0,
7, 0, 0,
7, 3, 1,
6, 3, 1000, ! tangential arc to endpoint
5, 3, 1001, ! tangential arc to endpoint
1, 90, 2000, ! tangential arc by radius and angle
2, 3, 1001, ! tangential arc to endpoint
1, 3, 900, ! set centerpoint
1, 2, 3000, ! arc using startpoint, centerpoint and point on final radius
1, 2.5, 900, ! set centerpoint
0, -180, 4001, ! arc using start point, centerpoint and angle
1, 5, 1000, ! tangential arc to endpoint
-1, 0, 100, ! segment by (dx, dy)
2, 225, 200, ! segment by (len, angle)
-1, 0, 800, ! set tangent
-1, 0, 1000, ! tangential arc to endpoint
0, 0, -1, ! end of contour
1, 1, 900, ! set centerpoint
0.5, 360, 4000, ! full circle by centerpoint and radius
3.5, 1.5, 900, ! set centerpoint
1, 360, 4001 ! full circle by centerpoint and radius
```

Example 2:

```

EXTRUDE 2+5+10+10+2, 0, 0, 3, 1+2+4+16+32,
0, 0, 900,
3, 360, 4001,
2.5, -1, 0,
2.5, 1, 0,
1.5, 1, 1,
1.5, -1, 1001,
2.5, -1, -1,
0, 2.5, 600,
0, -1, 800,
1, 1.5, 1001,
-1, 0, 800,
0, 0.5, 1001,
0, 1, 800,
-1, 1.5, 1001,
1, 0, 800,
0, 2.5, 1001,
0, 2.5, 700,
-1.5, 0, 900,
-2.5, 0, 600,
-2.5, 1, 3000,
-2.5, 1, 0,
-1.5, 1, 0,
-1.5, -1, 1001,
-2.5, -1, 0,
SQRT(2)-1, 45, 200,
-2.5, 0, 3000,
-2.5, 0, 700,
0, -1.5, 900,
1, 360, 4000

```

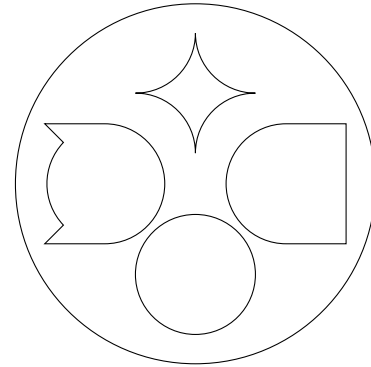

Example 3:

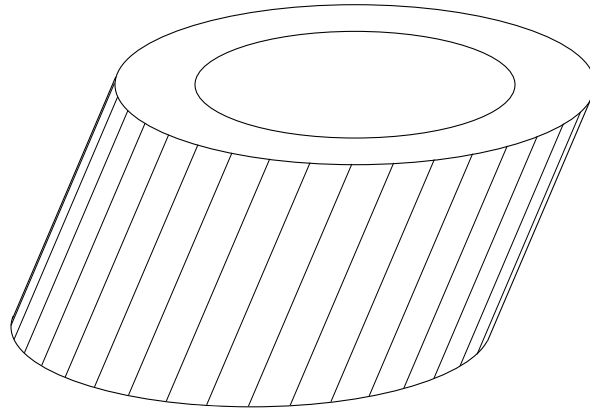

```
EXTRUDE 3, 1, 1, 3, 1+2+4+16+32,  
        0, 0, 900,  
        3, 360, 4001,  
        2, 360, 4000
```

Example 4:

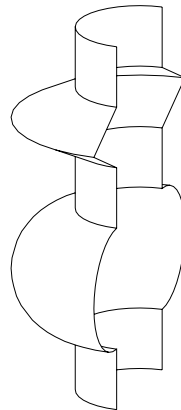

```
ROTY-90
REVOLVE 9, 180, 16+32,
        7, 1, 0,
        6, 1, 0,
        5.5, 2, 0,
        5, 1, 0,
        4, 1, 0,
        3, 1, 900, ! set centerpoint
        0, 180, 4001, ! arc using startpoint, centerpoint and angle
        2, 1, 0,
        1, 1, 0
```

ATTRIBUTES

In the first part of this chapter, directives influencing the interpretation of GDL statements are presented. Directives may define the smoothness used for cylindrical elements, representation mode in the 3D view or the assignment of an attribute (color, material, text style, etc.) for the subsequent shapes. Inline attribute definition is covered in the second part. This feature allows you to assign to your objects customized materials, textures, fill patterns, line types and text styles that are not present in the current attribute set of your project.

DIRECTIVES

The influence of directives on the interpretation of the subsequent GDL statements remains in effect until the next directive or the end of the script. Called scripts inherit the current settings: the changes have local influence. Returning from the script resets the settings as they were before the macro call.

Directives for 3D and 2D Scripts

LET

```
[LET] varnam = n
```

Value assignment. The LET directive is optional. The variable will store the evaluated value of n.

RADIUS

```
RADIUS radius_min, radius_max
```

Sets smoothness for cylindrical elements and arcs in polylines.

A circle with a radius of r is represented:

- if $r < \text{radius_min}$, by a hexagon,
- if $r \geq \text{radius_max}$, by a 36-edged polygon,
- if $\text{radius_min} < r < \text{radius_max}$, by a polygon of $(6+30*(r-\text{radius_min})/(\text{radius_max}-\text{radius_min}))$ edges.

Arc conversion is proportional to this.

After a RADIUS statement, all previous RESOL and TOLER statements lose their effect.

Restriction of parameters:

```
r_min <= r_max
```

Example:

```
RADIUS 1.1, 1.15  
CYLIND 3.0, 1.0
```

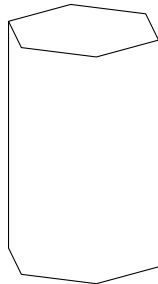

```
RADIUS 0.9, 1.15  
CYLIND 3.0, 1.0
```

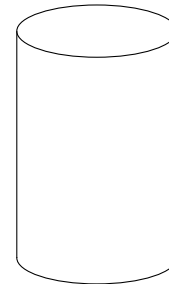

RESOL

RESOL n

Sets smoothness for cylindrical elements and arcs in polylines. Circles are converted to regular polygons having n sides.

Arc conversion is proportional to this.

After a RESOL statement, any previous RADIUS and TOLER statements lose their effect.

Restriction of parameters:

n >= 3

Default:

RESOL 36

Example:

```
RESOL 5  
CYLIND 3.0, 1.0
```



```
RESOL 36  
CYLIND 3.0, 1.0
```

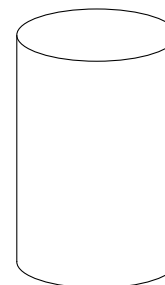

TOLER

TOLER d

Sets smoothness for cylindrical elements and arcs in polylines. The error of the arc approximation (i.e., the greatest distance between the theoretical arc and the generated chord) will be smaller than d.

After a TOLER statement, any previous RADIUS and RESOL statements lose their effect.

Example:

```
TOLER 0.1  
CYLIND 3.0, 1.0
```



```
TOLER 0.01  
CYLIND 3.0, 1.0
```

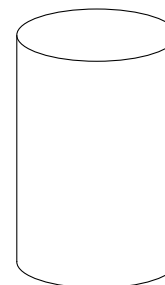

Note

The **RADIUS**, **RESOL** and **TOLER** directives set smoothness for cylindrical 3D elements (**CIRCLE**, **ARC**, **CYLIND**, **SPHERE**, **ELLIPS**, **CONE**, **ARMC**, **ARME**, **ELBOW**, **REVOLVE**) and arcs in 2D polylines using curved edges.

See the section called “Additional Status Codes”.

PEN

PEN n

Sets the color.

Restriction of parameters:

$0 < n \leq 255$

Default:

PEN 1

if there is no PEN statement in the script.

(For library parts, default values come from the library part's settings. If the script refers to a non-existing index, PEN 1 becomes the default setting.)

LINE_PROPERTY

LINE_PROPERTY *expr*

Defines the property for all subsequently generated lines in the 2D script (RECT2, LINE2, ARC2, CIRCLE2, SPLINE2, SPLINE2A, POLY2, FRAGMENT2 commands) until the next LINE_PROPERTY statement. Default value is generic.

expr: possible values:

- 0: all lines are generic lines,
- 1: all lines are inner,
- 2: all lines are contour.

[SET] STYLE

[**SET**] **STYLE** *name_string*

[**SET**] **STYLE** *index*

All the texts generated afterwards will use that style until the next SET STYLE statement.

The index is a constant referring to a style stack in the internal data structure (negative indices mean indices in the data structure of inline materials (previously defined in the GDL script)). This stack is modified during GDL analysis and can also be modified from within the program. The use of the index instead of the style name is only recommended with the prior use of the IND function.

Default:

SET STYLE 0

(application font, size 5 mm, anchor = 1, normal face) if there is no SET STYLE statement in the script.

Directives Used in 3D Scripts Only

MODEL

MODEL WIRE

MODEL SURFACE

MODEL SOLID

Sets the representation mode in the current script.

MODEL WIRE: only wireframe, no surfaces or volumes. Objects are transparent.

MODEL SURFACE, MODEL SOLID: The generation of the section surfaces is based on the relation of the boundary surfaces, so that both methods generate the same 3D internal data structure. Objects are opaque.

The only distinction can be seen after cutting away a part of the body:

MODEL SURFACE: the inside of bodies will be visible,

MODEL SOLID: new surfaces may appear.

Default:

MODEL SOLID

Example: To illustrate the three modeling methods, consider the following three blocks:

```
MODEL WIRE
BLOCK 3, 2, 1
ADDY 4
MODEL SURFACE
BLOCK 3, 2, 1
ADDY 4
MODEL SOLID
BLOCK 3, 2, 1
```

After cutting them with a plane:

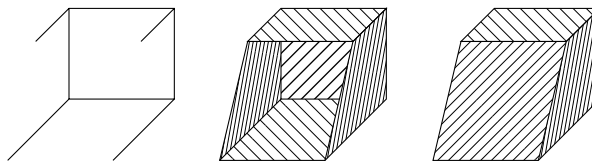

[SET] MATERIAL

[SET] MATERIAL name_or_index

All the surfaces generated afterwards will represent that material until the next MATERIAL statement. Surfaces in the BPRISM_, CPRISM_, FPRISM_, HPRISM_, SPRISM_, CSLAB_, CWALL_, BWALL_, XWALL_, CROOF_, MASS, bodies are exceptions to this rule.

The index is a constant referring to a material stack in the internal data structure (negative indices mean indices in the data structure of inline materials (previously defined in the GDL script)). This stack is modified during GDL analysis and can also be modified from within the program. The use of the index instead of the material name is only recommended with the prior use of the IND function.

index 0 has a special meaning: surfaces use the color of the current pen and they have a matte appearance.

Default:

MATERIAL 0

if there is no MATERIAL statement in the script.

(For Library parts, default values are read from the Library part's settings. If the script refers to a non-existing index, MATERIAL 0 becomes the default setting.)

[SET] BUILDING_MATERIAL

```
[SET] BUILDING_MATERIAL name_or_index
      [, cut_fill_pen [, cut_fill_bkgd_pen, [iOverrideFlag]]]
```

Compatibility: introduced in ARCHICAD 21.

All the shapes generated afterwards will represent the surface, cut fill type (in Section/Elevation), foreground and background pens of the set building material.

cut_fill_pen: custom cut fill foreground pen index to override the index of the active building material attribute

cut_fill_bkgd_pen: custom cut fill background pen index to override the index of the active building material attribute

iOverrideFlag: enable "cut_fill_pen" and/or "cut_fill_bkgd_pen" to take effect

iOverrideFlag = j1 + 2*j2: , where each j can be 0 or 1.

j1: Override cut fill foreground pen with cut_fill_pen

j2: Override cut fill background pen with cut_fill_bkgd_pen

Override parameters are optional: if the "iOverrideFlag" is not set, or the DEFAULT keyword is used in any of the override pen index parameters, the building material attributes will take effect.

Example: Overriding the cut fill background pen

```
BUILDING_MATERIAL buildingMatIndex, DEFAULT, cut_fill_bkgd_pen
```

All the surfaces generated afterwards will represent the surface of the building material until the next BUILDING_MATERIAL, MATERIAL, SECT_FILL or SECT_ATTRS statement. Surfaces in the BPRISM_, CPRISM_, FPRISM_, HPRISM_, SPRISM_, CSLAB_, CWALL_, BWALL_, XWALL_, CROOF_, MASS, bodies are exceptions to this rule.

In Section/Elevation, the displayed cut fill foreground and background pens will match the same attributes of the building material (or the override parameters set in the command itself), until the next BUILDING_MATERIAL, MATERIAL, SECT_FILL or SECT_ATTRS statement.

A previous BUILDING_MATERIAL statement has no further control of shapes generated after using SECT_FILL or SECT_ATTRS statements. Shapes generated after using the following statements keep their BUILDING_MATERIAL settings: the MATERIAL statement overrides only the surfaces of the generated shape, the SECT_ATTRS{2} statement controls the representation of the contour pen and line type in section view only, while the rest of the attributes are still controlled the building material itself.

The index is a constant referring to a building material stack in the internal data structure. The use of the index instead of the building material name is only recommended with the prior use of the IND function.

index 0 has a special meaning: the generated section eliminates the lines based on the fills.

Default:

BUILDING_MATERIAL 0

if there is no BUILDING_MATERIAL statement in the script.

(For Library parts, default values are read from the Library part's settings. If the script refers to a non-existing index, BUILDING_MATERIAL 0 becomes the default setting.)

SECT_FILL

SECT_FILL fill, fill_background_pen,
fill_pen, contour_pen

or

SECT_ATTRS

SECT_ATTRS fill, fill_background_pen,
fill_pen, contour_pen [, line_type]

Defines the attributes used for the cut part of the 3D elements in the Section/Elevation window. *Compatibility: up to ARCHICAD 19 the PROJECT2{3} command is affected too.* Inline fill and line_type attributes (defined in master script or 3d script) are not accepted.

fill: fill name or index number.

fill_background_pen: fill background pencolor number.

fill_pen: fill pencolor number.

contour_pen: fill contour pencolor number.

line_type: line type of polygon edges.

SECT_ATTRS{2}

SECT_ATTRS{2} contour_pen [, line_type]

Compatibility: introduced in ARCHICAD 21.

Defines the contour pen and line type used for the cut part of the 3D elements in Section/Elevation. Can be combined with BUILDING_MATERIAL statement for handling all of the Section/Elevation attributes. Inline line_type attribute (defined in master script or 3d script) is not accepted.

contour_pen: fill contour pencolor number.

line_type: line type of polygon edges.

SHADOW

SHADOW casting [, catching]

Controls the shadow casting of the elements in PhotoRendering and in vectorial shadow casting.

casting: ON, AUTO or OFF

ON: all the subsequent elements will cast shadows in all circumstances,

OFF: none of the subsequent elements will cast shadows in any circumstance,

AUTO: shadow casting will be determined automatically

Setting SHADOW OFF for hidden parts will spare memory space and processing time.

Setting SHADOW ON ensures that even tiny details will cast shadows.

catching: ON or OFF

This optional parameter controls the appearance of shadows (from other bodies) on surfaces.

If shadow casting isn't specified, the default will be AUTO.

Example:

```
SHADOW OFF
! horizontal surface
PRISM 4, 0.2,
    0, 0,
    6, 0,
    6, 6,
    0, 6

ADDX 0.5
ADDY 2.5

BRICK 1, 1, 1
ADDX 2
SHADOW ON
BRICK 1, 1, 2
ADDX 2
SHADOW OFF
BRICK 1, 1, 3

DEL 4
```

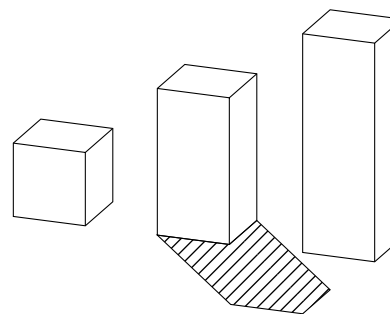

Directives Used in 2D Scripts Only

DRAWINDEX

DRAWINDEX number

Defines the drawing order of 2D Script elements. Elements with a smaller drawindex will be drawn first.

Restriction of parameters:

0 < number <= 50

(In the current version of GDL only the 10, 20, 30, 40 and 50 DRAWINDEX values are valid. Other values will be rounded to these.)

If no DRAWINDEX directive is present, the default drawing order is the following:

- 1 Figures
- 2 Fills
- 3 Lines
- 4 Text elements

[SET] FILL

[SET] **FILL** name_string

[SET] **FILL** index

All the 2D polygons generated afterwards will represent that fill until the next SET FILL statement.

The index is a constant referring to a fill stack in the internal data structure. This stack is modified during GDL analysis and can also be modified from within the program. The use of the index instead of the fill name is only recommended with the prior use of the IND function.

Default:

SET FILL 0

i.e., empty fill, if there is no SET FILL statement in the script.

[SET] LINE_TYPE

[SET] **LINE_TYPE** name_string

[SET] **LINE_TYPE** index

All the 2D lines generated afterwards will represent that line type (in lines, arcs, polylines) until the next SET LINE_TYPE statement. The index is a constant that refers to a line type stack in the internal data structure. This stack is modified during GDL analysis and can also be modified from the program. The use of the index instead of the line type name is only recommended with the prior use of the IND function.

Default:

SET LINE_TYPE 1

i.e., solid line, if there is no SET LINE_TYPE statement in the script.

INLINE ATTRIBUTE DEFINITION

Attributes in can be created using the material, fill and line type dialog boxes. These floor plan attributes can be referenced from any GDL script. Attributes can also be defined in GDL scripts. There are two different cases:

- Attribute definition in the MASTER_GDL script. The MASTER_GDL script is interpreted when the library that contains it is loaded in the memory. The MASTER_GDL attributes are merged into the floor plan attributes; attributes with the same names are not replaced. Once the MASTER_GDL is loaded, the attributes defined in it can be referenced from any script.
- Attribute definition in library parts. The materials and textures defined this way can be used in the script and its second generation scripts. Fills and line types defined and used in the master or 2D script have the same behavior as if they were defined in the MASTER_GDL script, but only if used by name or index (not through a parameter). Fills and line types defined in the master or 3D script can't be accessed in the 3D script.

The Check GDL Script command in the script window helps to verify whether the material, fill, line type or style parameters are correct.

When a material, fill, line type or style is different in the 3D interpretation of the library part from the intended one, but there is no error message, this probably means that one or more of the parameter values are incorrect. The Check GDL Scripts command will help you with detailed messages to find these parameters.

Materials

DEFINE MATERIAL

```
DEFINE MATERIAL name type,
    surface_red, surface_green, surface_blue
    [, ambient_ce, diffuse_ce, specular_ce, transparent_ce,
    shining, transparency_attenuation
    [, specular_red, specular_green, specular_blue,
    emission_red, emission_green, emission_blue, emission_att]]
    [, fill_index [, fillcolor_index, texture_index]]
```

Note: This command can contain additional data definition.

See the section called “Additional Data” for details.

Any GDL script can include material definitions prior to the first reference to that material name. This material can only be used for 3D elements in its own script and its second generation scripts.

name: name of the material.

type: type of the material. The actual number (n) of parameters that define the material is different, depending on the type. The meaning of the parameters and their limits are explained in the examples' comments.

0: general definition, n=16,

1: simple definition, n=9 (extra parameters are constants or calculated from given values),

2-7: predefined material types, n=3. The three values are the RGB components of the surface color. Other parameters are constants or calculated from the color.

2: matte,

3: metal,

4: plastic,

5: glass,

6: glowing,

7: constant,

10: general definition with fill parameter, n=17,

11: simple definition with fill parameter, n=10,

12-17: predefined material types with fill parameter, n=4,

20: general definition with fill, color index of fill and index of texture parameters, n=19,

21: simple definition with fill, color index of fill and index of texture parameters, n=12,

22-27: predefined material types with fill, color index of fill and index of texture parameters, n=6.

20-27: Special meanings for types 20-27: If the pen number is zero, vectorial hatches will be generated with the active pen. Zero value for a texture or fill index allows you to define materials without a vectorial hatch or texture.

Example 1: Materials with solid colors

```
DEFINE MATERIAL "water" 0,
    0.5284, 0.5989, 0.6167, ! surface RGB [0.0..1.0]
    1.0, ! ambient coefficient [0.0..1.0]
    0.5, ! diffuse coefficient [0.0..1.0]
    0.5, ! specular coeff. [0.0..1.0]
    0.9, ! transparent coeff. [0.0..1.0]
    2.0, ! shining [0.0..100.0]
    1, ! transparency atten. [0.0..4.0]
    0.5284, 0.5989, 0.6167, ! specular RGB [0.0..1.0]
    0, 0, 0, ! emission RGB [0.0..1.0]
    0.0 ! emission atten. [0.0..65.5]
```



```

DEFINE MATERIAL "asphalt" 1,
  0.1995, 0.2023, 0.2418, ! surface RGB [0.0..1.0]
  1.0, 1.0, 0.0, 0.0,
  ! ambient, diffuse, specular, transparent
  ! coefficients [0.0..1.0]
  0, ! shining [0..100]
  0 ! transparency attenuation [0..4]
DEFINE MATERIAL "matte red" 2,
  1.0, 0.0, 0.0 ! surface RGB [0.0..1.0]

```

Example 2: Material with fill

```

DEFINE MATERIAL "Brick-Red" 10,
  0.878294, 0.398199, 0.109468,
  0.58, 0.85, 0.0, 0.0,
  0,
  0.0,
  0.878401, 0.513481, 0.412253,
  0.0, 0.0, 0.0,
  0,
  IND(FILL, "common brick") ! fill index

```

Example 3: Material with fill and texture

```

DEFINE MATERIAL "Yellow Brick+*" 20,
  1, 1, 0, ! surface RGB [0.0 .. 1.0]
  0.58, 0.85, 0, 0,
  ! ambient, diffuse, specular, transparent
  ! coefficients [0.0 .. 1.0]
  0, ! shining [0.0 .. 100.0]
  0, ! transparency attenuation [0.0 .. 4.0]
  0.878401, 0.513481, 0.412253, ! specular RGB [0.0 .. 1.0]
  0, 0, 0, ! emission RGB [0.0 .. 1.0]
  0, ! emission attenuation [0.0 .. 65.5]
  IND(FILL, "common brick"), 61,
  IND(TEXTURE, "Brick")
  ! Fill index, color index, texture index

```

DEFINE MATERIAL BASED_ON

```

DEFINE MATERIAL name [,] BASED_ON orig_name [,] PARAMETERS name1 = expr1 [, ...]
  [[,] ADDITIONAL_DATA name1 = expr1 [, ...]]

```

Material definition based on an existing material. Specified parameters of the original material will be overwritten by the new values, other parameters remain untouched. Using the command without actual parameters results in a material exactly the same as the original, but with a different name. Parameter values of a material can be obtained using the REQUEST{2} ("Material_info", ...) function.

orig_name: name of the original material (name of an existing, previously defined GDL or floor plan material).

namei: material parameter name to be overwritten by a new value. Names corresponding to parameters of material definition:

gs_mat_surface_r, gs_mat_surface_g, gs_mat_surface_b: (surface RGB [0.0..1.0])
 gs_mat_ambient: (ambient coefficient [0.0..1.0])
 gs_mat_diffuse: (diffuse coefficient [0.0..1.0])
 gs_mat_specular: (specular coefficient [0.0..1.0])
 gs_mat_transparent: (transparent coefficient [0.0..1.0])
 gs_mat_shining: (shininess [0.0..100.0])
 gs_mat_transp_att: (transparency attenuation [0.0..4.0])
 gs_mat_specular_r, gs_mat_specular_g, gs_mat_specular_b: (specular color RGB [0.0..1.0])
 gs_mat_emission_r, gs_mat_emission_g, gs_mat_emission_b: (emission color RGB [0.0..1.0])
 gs_mat_emission_att: (emission attenuation [0.0..65.5])
 gs_mat_fill_ind: (fill index)
 gs_mat_fillcolor_ind: (fill color index)
 gs_mat_texture_ind: (texture index)

expri: new value to overwrite the specified parameter of the material. Value ranges are the same as at the material definition.

Example:

```
n = REQUEST{2} ("Material_info", "Brick-Face", "gs_mat_emission_rgb",
  em_r, em_g, em_b)
em_r = em_r + (1 - em_r) / 3
em_g = em_g + (1 - em_g) / 3
em_b = em_b + (1 - em_b) / 3
DEFINE MATERIAL "Brick-Face light" [,] BASED_ON "Brick-Face" \
  PARAMETERS gs_mat_emission_r = em_r,
  gs_mat_emission_g = em_g, gs_mat_emission_b = em_b
SET MATERIAL "Brick-Face"
BRICK a, b, zzyzx
ADDX a
SET MATERIAL "Brick-Face light"
BRICK a, b, zzyzx
```

DEFINE TEXTURE

DEFINE TEXTURE name expression, x, y, mask, angle

Any GDL script can include texture definition prior to the first reference to that texture name. The texture can be used only in the script in which it was defined and its subsequent second generation scripts.

name: name of the texture.

expression: picture associated with the texture. A string expression means a file name, a numerical expression an index of a picture stored in the library part. A 0 index is a special value which refers to the preview picture of the library part.

x: logical width of the texture.

y: logical height of the texture.

mask:

$\text{mask} = j_1 + 2*j_2 + 4*j_3 + 8*j_4 + 16*j_5 + 32*j_6 + 64*j_7 + 128*j_8 + 256*j_9$, where each j can be 0 or 1.

Alpha channel controls ($j_1 \dots j_6$):

j_1 : alpha channel changes the transparency of texture,

j_2 : Bump mapping or surface normal perturbation. Bump mapping uses the alpha channel to determine the amplitude of the surface normal,

j_3 : alpha channel changes the diffuse color of texture,

j_4 : alpha channel changes the specular color of texture,

j_5 : alpha channel changes the ambient color of texture,

j_6 : alpha channel changes the surface color of texture,

Connection controls ($j_7 \dots j_9$): (If the value is zero, normal mode is selected.)

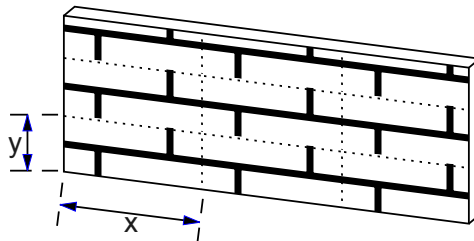

j_7 : the texture will be shifted randomly,

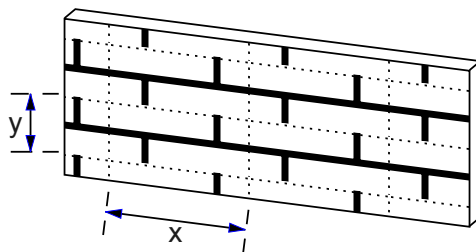

j_8 : mirroring in x direction,

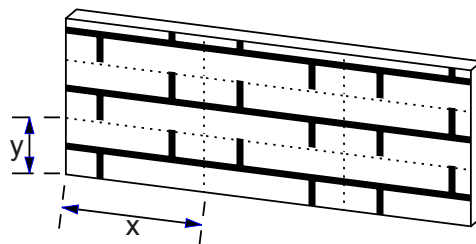

j_9 : mirroring in y direction.

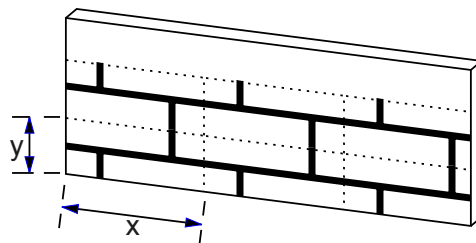

angle: angle of the rotation.

Example:

```
DEFINE TEXTURE "Brick" "Brick.PICT", 1.35, 0.3, 256+128, 35.0
```

Fills

DEFINE FILL

```

DEFINE FILL name [[,] FILLTYPES_MASK fill_types,]
    pattern1, pattern2, pattern3, pattern4,
    pattern5, pattern6, pattern7, pattern8,
    spacing, angle, n,
    frequency1, direction1, offset_x1, offset_y1, m1,
    length11, ..., length1m,
    ...
    frequencyn, directionn, offset_xn,
    lengthn1, ..., lengthnm
  
```

Note 1: This command can contain additional data definition.

See the section called “Additional Data” for details.

Any GDL script may include fill definitions prior to the first reference to that fill name. The fill defined this way can be used only for 2D elements in the script in which it was defined and its subsequent second generation-scripts.

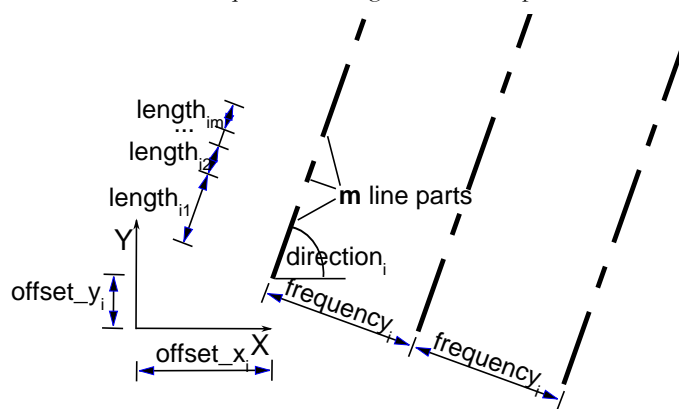

name: name of the fill.

fill_types:

$fill_types = j_1 + 2*j_2 + 4*j_3$, where each j can be 0 or 1.

j_1 : cut fills,

j_2 : cover fills,
 j_3 : drafting fills.

If the j bit is set, the defined fill can be used corresponding to its specified type. Default is all fills (0).

pattern definition: **pattern1**, **pattern2**, **pattern3**, **pattern4**, **pattern5**, **pattern6**, **pattern7**, **pattern8**: 8 numbers between 0 and 255 representing binary values. Defines the bitmap pattern of the fill.

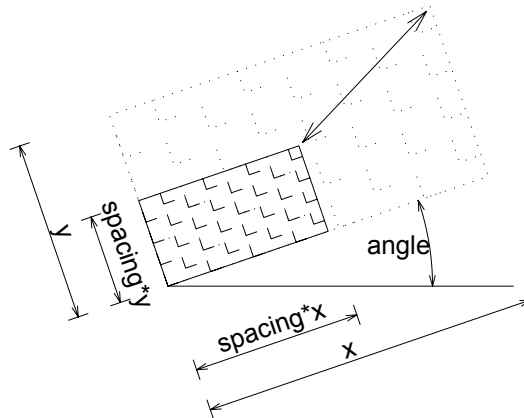

spacing: hatch spacing - defines a global scaling factor for the whole fill. All values will be multiplied by this number in both the x and y direction.

angle: global rotation angle in degrees.

n: number of hatch lines.

frequencyi: frequency of the line (the distance between two lines is $\text{spacing} * \text{frequencyi}$).

diriri: direction angle of the line in degrees.

offset_xi, **offset_yi**: offset of the line from the origin.

mi: number of line parts.

lengthij: length of the line parts (the real length is $\text{spacing} * \text{lengthij}$). Line parts are segments and spaces following each other. First line part is a segment, zero length means a dot.

The bitmap pattern is only defined by the pattern1... pattern8 parameters and is used when the display options for Polygon Fills are set to "Bitmap Pattern". To define it, choose the smallest unit of the fill, and represent it as dots and empty spaces using a rectangular grid with 8x8 locations. The 8 pattern parameters are decimal representations of the binary values in the lines of the grid (a dot is 1, an empty space is 0).

The vectorial hatch is defined by the second part of the fill definition as a collection of dashed lines repeated with a given frequency (frequencyi). Each line of the collection is described by its direction (directioni), its offset from the origin (offset_xi, offset_yi) and the dashed line definition which contains segments and spaces with the given length (lengthij) following each other.

Note 2: Only simple fills can be defined with the DEFINE FILL command. There is no possibility to define symbol fills with this command.

Example:

```
DEFINE FILL "brick" 85, 255, 136, 255,
  34, 255, 136, 255,
  0.08333, 0.0, 4,
  1.0, 0.0, 0.0, 0.0, 0,
  3.0, 90.0, 0.0, 0.0, 2,
  1.0, 1.0,
  3.0, 90.0, 1.5, 1.0, 4,
  1.0, 3.0, 1.0, 1.0,
  1.5, 90.0, 0.75, 3.0, 2,
  1.0, 5.0
```

Bitmap pattern:

Pattern:	Binary value:
pattern1 = 85	01010101
pattern2 = 255	11111111
pattern3 = 136	10001000 . .
pattern4 = 255	11111111
pattern5 = 34	00100010 . .
pattern6 = 255	11111111
pattern7 = 136	10001000 . .
pattern8 = 255	11111111

View:

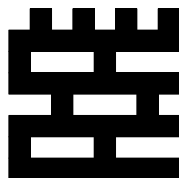

Vectorial hatch:

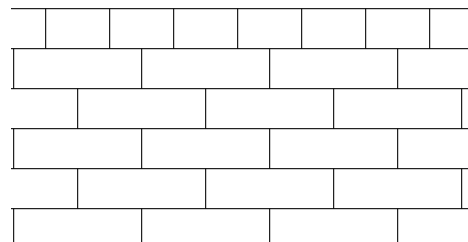

DEFINE FILLA

```

DEFINE FILLA name [,] [FILLTYPES_MASK fill_types,]
  pattern1, pattern2, pattern3, pattern4,
  pattern5, pattern6, pattern7, pattern8,
  spacing_x, spacing_y, angle, n,
  frequency1, directional_offset1, direction1,
  offset_x1, offset_y1, m1,
  length1, ..., lengthm,
  ...
  frequencyn, directional_offsetn, directionn,
  offset_xn, offset_yn, mn,
  lengthn1, ..., lengthnm

```

Note: This command can contain additional data definition.

See the section called “Additional Data” for details.

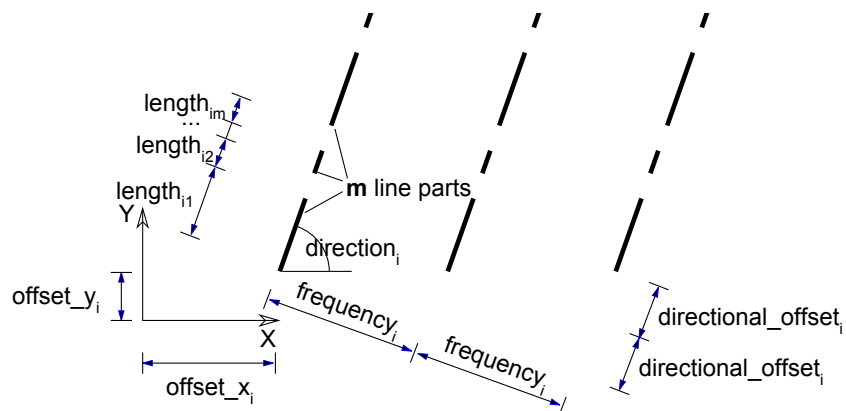

An extended DEFINE FILL statement.

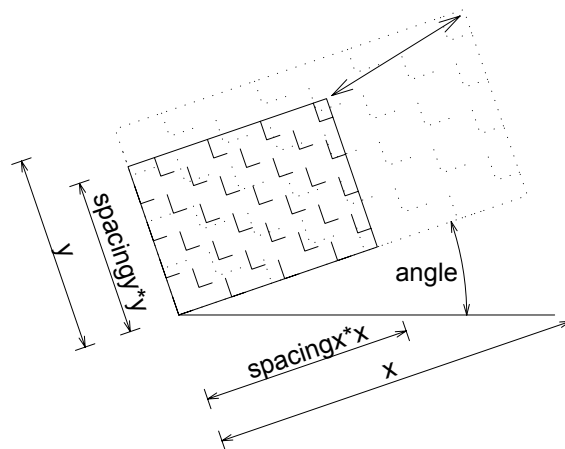

spacing_x, spacing_y: spacing factor in the x and y direction, respectively. These two parameters define a global scaling factor for the whole fill. All values in the x direction will be multiplied by spacing_x and all values in the y direction will be multiplied by spacing_y.

directional_offseti: the offset of the beginning of the next similar hatch line, measured along the line's direction. Each line of the series will be drawn at a distance defined by frequency_i with an offset defined by directional_offset_i. The real length of the offset will be modulated by the defined spacing.

Example:

```
DEFINE FILLA "TEST" 8, 142, 128, 232,
    8, 142, 128, 232,
    0.5, 0.5, 0, 2,
    2, 1, 90, 0,
    0, 2, 1, 1,
    1, 2, 0, 0, 0,
    2, 1, 3
FILL "TEST"
POLY2 4, 6,
    -0.5, -0.5, 12, -0.5,
    12, 6, -0.5, 6
```

Bitmap pattern:

Pattern:	Binary value:
pat1 = 8	00001000 •
pat2 = 142	10001110 • ...
pat3 = 128	10000000 •
pat4 = 232	11101000 ... •
pat5 = 8	00001000 •
pat6 = 142	10001110 • ...
pat7 = 128	10000000 •
pat8 = 232	11101000 ... •

View:



Vectorial hatch:

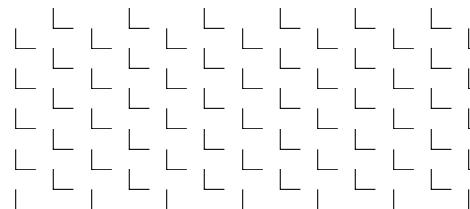

DEFINE SYMBOL_FILL

```

DEFINE SYMBOL_FILL name [,][FILLTYPES_MASK fill_types,]
    pat1, pat2, pat3, pat4, pat5, pat6, pat7, pat8,
    spacingx1, spacingy1, spacingx2, spacingy2,
    angle, scaling1, scaling2, macro_name [,] PARAMETERS [name1
    = value1, ..., namen = valuen]
  
```

Note: This command can contain additional data definition.

See the section called “Additional Data” for details.

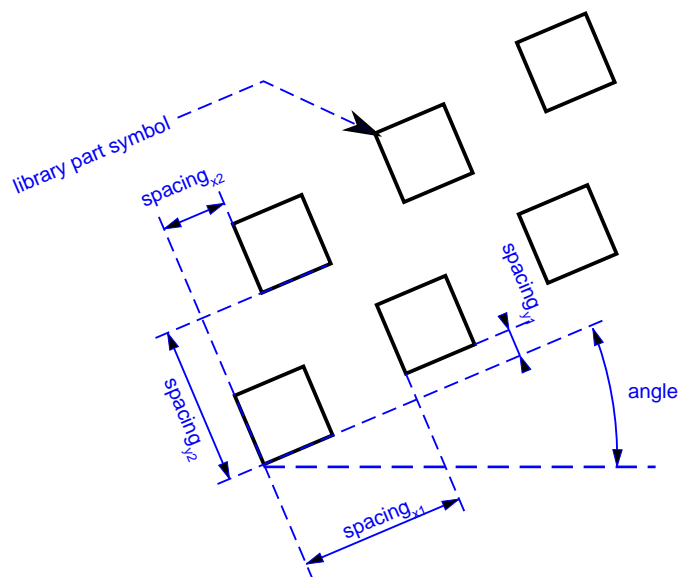

An extended DEFINE FILL statement, which allows you to include a library part drawing in a fill definition. The usage of macro_name and the parameters are the same as for the CALL command.

spacingx1, spacingx2: horizontal spacings.

spacingy1, spacingy2: vertical spacings.

scaling1: horizontal scale.

scaling2: vertical scale.

macro_name: the name of the library part.

DEFINE SOLID_FILL

DEFINE SOLID_FILL name [[,] **FILLTYPES_MASK** fill_types]

Defines a solid fill.

Note: This command can contain additional data definition.

See the section called “Additional Data” for details.

DEFINE EMPTY_FILL

DEFINE EMPTY_FILL name [[,] **FILLTYPES_MASK** fill_types]

Defines an empty fill.

Note: This command can contain additional data definition.

See the section called “Additional Data” for details.

DEFINE LINEAR_GRADIENT_FILL

DEFINE LINEAR_GRADIENT_FILL name [[,] **FILLTYPES_MASK** fill_types]

Define linear gradient fill.

DEFINE RADIAL_GRADIENT_FILL

DEFINE RADIAL_GRADIENT_FILL name [[,] **FILLTYPES_MASK** fill_types]

Define radial gradient fill.

DEFINE TRANSLUCENT_FILL

DEFINE TRANSLUCENT_FILL name [[,] **FILLTYPES_MASK** fill_types]
pat1, pat2, pat3, pat4, pat5, pat6, pat7, pat8,
percentage

Define a fill, which shows the background and foreground colors in mixture defined by the given percentage value.

percentage: percentage of foreground color opacity; 0 displays background color only (like empty fill), 100 displays the foreground color only (like solid fill).

DEFINE IMAGE_FILL

```
DEFINE IMAGE_FILL name image_name [[,] FILLTYPES_MASK fill_types]
    part1, part2, part3, part4, part5, part6, part7, part8,
    image_vert_size, image_hor_size, image_mask, image_rotangle
```

Define a fill based on an image pattern.

image_name: name of the pattern image loaded in the current library.

image_vert_size, image_hor_size: model size of the pattern.

image_mask: tiling directive

$image_mask = 1024*j_{11} + 2048*j_{12}$, where each j can be 0 or 1.

For more information about laying out images on a surface see the DEFINE TEXTURE command.

j_{11} : mirroring in x direction

j_{12} : mirroring in y direction

image_rotangle: rotation angle of the pattern from the normal coordinate system.

Line Types

DEFINE LINE_TYPE

```
DEFINE LINE_TYPE name spacing, n,
    length1, ..., lengthn
```

Note 1: This command can contain additional data definition.

See the section called "Additional Data" for details.

Any GDL script may include line type definitions prior to the first reference to that line-type name. The line type defined this way can be used only for 2D elements in the script in which it was defined and its subsequent second generation scripts.

name: name of the line type.

spacing: spacing factor.

n: number of the line parts.

lengthi: length of the line parts (the real length is $spacing * length_i$). Line parts consist of segments and spaces. First line part is a segment, zero length means a dot.

Note 2: Only simple line types - i.e. consisting only of segments and spaces - can be defined with this command, defining symbol line types can be done with the DEFINE SYMBOL_LINE command.

Example:

```
DEFINE LINE TYPE "line - - ." 1,
    6, 0.005, 0.002, 0.001, 0.002, 0.0, 0.002
```

DEFINE SYMBOL_LINE

```
DEFINE SYMBOL_LINE name dash, gap, macro_name PARAMETERS [name1 = value1,
    ...
    namen = valuen]
```

Note: This command can contain additional data definition.

See the section called “Additional Data” for details.

An extended DEFINE LINE statement, which allows you to include a library part drawing in a line definition. The usage of macro_name and the parameters are the same as for the CALL command.

dash: scale of both line components.

gap: gap between each component.

Text Styles and Text Blocks

DEFINE STYLE

```
DEFINE STYLE name font_family, size, anchor, face_code
```

Recommended to be used with the TEXT2 and TEXT commands.

GDL scripts may include style definitions prior to the first reference to that style name. The style defined this way can be used only in the script in which it was defined and its subsequent second generation scripts.

name: name of the style.

font_family: name of the used font family (e.g., Garamond).

size: height of the "I" character in millimeters in paper space or meters in model space.

If the defined style is used with the TEXT2 and TEXT commands, size means character heights in millimeters.

If used with PARAGRAPH strings in the RICHTEXT2 and RICHTEXT commands, size meaning millimeters or meters depends on the fixed_height parameter of the TEXTBLOCK definition, while the outline and shadow face_code values and the anchor values are not effective.

anchor: code of the position point in the text.

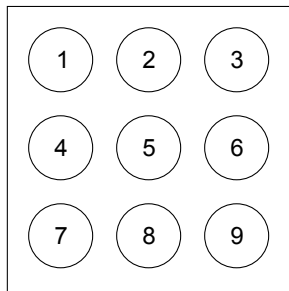

face_code: a combination of the following values:

$\text{face_code} = j_1 + 2*j_2 + 4*j_3$, where each j can be 0 or 1.

j_1 : bold,

j_2 : italic,

j_3 : underline,

If $\text{face_code} = 0$, then style is normal.

DEFINE STYLE{2}

DEFINE STYLE{2} name font_family, size, face_code

New version of style definition, recommended to be used with PARAGRAPH definitions.

name: name of the style.

font_family: name of the used font family (e.g., Garamond).

size: height of the characters in mm or m in model space.

face_code: a combination of the following values:

$\text{face_code} = j_1 + 2*j_2 + 4*j_3 + 32*j_6 + 64*j_7 + 128*j_8$, where each j can be 0 or 1.

j_1 : bold,

j_2 : italic,

j_3 : underline,

j_6 : superscript,

j_7 : subscript,

j_8 : strikethrough.

If $\text{face_code} = 0$, then style is normal.

If the defined style is used with the TEXT2 command, size means character heights in millimeters, while the superscript, subscript and strikethrough face_code values are not effective. If used with PARAGRAPH strings in the RICHTEXT2 and RICHTEXT commands, size meaning millimeters or meters depends on the fixed_height parameter of the TEXTBLOCK definition.

PARAGRAPH

```

PARAGRAPH name alignment, firstline_indent,
            left_indent, right_indent, line_spacing [,
            tab_position1, ...]
[PEN index]
[[SET] STYLE style1]
[[SET] MATERIAL index]
'string1'
'string2'
...
'string n'
[PEN index]
[[SET] STYLE style2]
[[SET] MATERIAL index]
'string1'
'string2'
...
'string n'
...

```

ENDPARAGRAPH

GDL scripts may include paragraph definitions prior to the first reference to that paragraph name. The paragraph defined this way can be used only in the script in which it was defined and its subsequent second generation scripts. A paragraph is defined to be a sequence of an arbitrary number of strings (max 256 characters long each) with different attributes: style, pen and material (3D). If no attributes are specified inside the paragraph definition, actual (or default) attributes are used. The new lines included in a paragraph string (using the special character '\n') will automatically split the string into identical paragraphs, each containing one line. Paragraph definitions can be referenced by name in the TEXTBLOCK command. All length type parameters (firstline_indent, left_indent, right_indent, tab_position) meaning millimeters or meters depends on the fixed_height parameter of the TEXTBLOCK definition.

name: name of the paragraph. Can be either string or integer. Integer identifiers works only with the TEXTBLOCK_ command

alignment: alignment of the paragraph strings. Possible values:

- 1: left aligned,
- 2: center aligned,

- 3: right aligned,
- 4: full justified.

firstline_indent: first line indentation, in mm or m in model space.

left_indent: left indentation, in mm or m in model space.

right_indent: right indentation, in mm or m in model space.

line_spacing: line spacing factor. The default distance between the lines (character size + distance to the next line) defined by the actual style will be multiplied by this number.

tab_positioni: consecutive tabulator positions (each relative to the beginning of the paragraph), in mm or m in model space. Tabulators in the paragraph strings will snap to these positions. If no tabulator positions are specified, default values are used (12.7 mm). Works only with '\t' special character.

stringi: part of the text. Can be either constant string or string type parameter.

TEXTBLOCK

TEXTBLOCK name width, anchor, angle, width_factor, charspace_factor, fixed_height, 'string_expr1' [, 'string_expr2', ...]

Textblock definition. GDL scripts may include textblock definitions prior to the first reference to that textblock name. The textblock defined this way can be used only in the script in which it was defined and its subsequent second generation scripts. A textblock is defined to be a sequence of an arbitrary number of strings or paragraphs which can be placed using the RICHTEXT2 command and the RICHTEXT command. Use the REQUEST ("TEXTBLOCK_INFO", ...) function to obtain information on the calculated width and height of a textblock.

name: name of the textblock, string type value.

width: textblock width in mm or m in model space, if 0 it is calculated automatically.

anchor: code of the position point in the text.

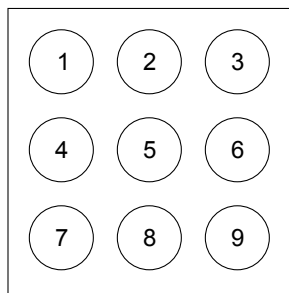

angle: rotation angle of the textblock in degrees.

width_factor: Character widths defined by the actual style will be multiplied by this number.

charspace_factor: The horizontal distance between two characters will be multiplied by this number.

fixed_height: Possible values:

1: the placed TEXTBLOCK will be scale-independent and all specified length type parameters will mean millimeters,

0: the placed TEXTBLOCK will be scale-dependent and all specified length type parameters will mean meters in model space.

string_expr*i*: means paragraph name if it was previously defined, simple string otherwise (with default paragraph parameters).

TEXTBLOCK

TEXTBLOCK *name* width, anchor, angle, width_factor, charspace_factor, fixed_height, n, 'expr_1' [, 'expr_2', ..., 'expr_n']

Similar to the TEXTBLOCK command. The meaning of all the parameters are the same, with the following additions:

expr_i: paragraph names can be either string or integer types within one textblock.

n: number of listed expr_i names

Additional Data

Attribute definitions can contain optional additional data definitions after the ADDITIONAL_DATA keyword. The additional data must be entered after the previously defined parameters of the attribute command. An additional data has a name (*name_i*) and a value (*value_i*), which can be an expression of any type, even an array. If a string parameter name ends with the substring "_file", its value is considered to be a file name and will be included in the archive project. Different meanings of additional data can be defined and used by the executing application.

Additional data definition is available in the following commands:

```

DEFINE MATERIAL parameters [[,] ADDITIONAL_DATA name1 = value1, name2 = value2, ...]
DEFINE MATERIAL name [,] BASED_ON orig_name [,] PARAMETERS name1 = expr1 [, ...]
    [[,] ADDITIONAL_DATA name1 = expr1 [, ...]]
DEFINE FILL parameters [[,] ADDITIONAL_DATA name1 = value1, name2 = value2, ...]
DEFINE FILLA parameters [[,] ADDITIONAL_DATA name1 = value1, name2 = value2, ...]
DEFINE SYMBOL_FILL parameters
    [[,] ADDITIONAL_DATA name1 = value1, name2 = value2, ...]
DEFINE SOLID_FILL name [[,] FILLTYPES_MASK fill_types]
    [[,] ADDITIONAL_DATA name1 = value1, name2 = value2, ...]
DEFINE EMPTY_FILL name [[,] FILLTYPES_MASK fill_types]
    [[,] ADDITIONAL_DATA name1 = value1, name2 = value2, ...]
DEFINE LINEAR_GRADIENT_FILL name [[,] FILLTYPES_MASK fill_types]
    [[,] ADDITIONAL_DATA name1 = value1, name2 = value2, ...]
DEFINE RADIAL_GRADIENT_FILL name [[,] FILLTYPES_MASK fill_types]
    [[,] ADDITIONAL_DATA name1 = value1, name2 = value2, ...]
DEFINE TRANSLUCENT_FILL name [[,] FILLTYPES_MASK fill_types]
    pat1, pat2, pat3, pat4, pat5, pat6, pat7, pat8,
    percentage [[,] ADDITIONAL_DATA name1 = value1, name2 = value2, ...]
DEFINE IMAGE_FILL name image_name [[,] FILLTYPES_MASK fill_types]
    part1, part2, part3, part4, part5, part6, part7, part8,
    image_vert_size, image_hor_size, image_mask, image_rotangle
    [[,] ADDITIONAL_DATA name1 = value1, name2 = value2, ...]
DEFINE LINE_TYPE parameters [[,] ADDITIONAL_DATA name1 = value1, name2 = value2, ...]
DEFINE SYMBOL_LINE parameters
    [[,] ADDITIONAL_DATA name1 = value1, name2 = value2, ...]

```

EXTERNAL FILE DEPENDENCE

FILE_DEPENDENCE

```
FILE_DEPENDENCE "name1" [, "name2", ...]
```

You can give a list of external files on which your GDL script depends on. File names should be constant strings.

All files specified here will be included in the archive project (like constant macro names used in CALL statements and constant picture names used in various GDL commands). The command works on this level only: if the specified files are library parts, their called macro files will not be included.

The command can be useful in cases when external files are referenced at custom places in the GDL script, for example: ADDITIONAL_DATA file parameters, data files in file operations.

NON-GEOMETRIC SCRIPTS

In addition to the 3D and 2D script windows that define the appearance of the GDL Object, further scripts are available for adding complementary information to it. These are the Properties Script used for quantity calculations, the Parameter Script that includes the list of possible values for different parameters, and the User Interface Script for creating a custom interface for parameter entry, Forward Migration Script and Backward Migration Scripts to define how to migrate an old instance forward to the actual element or how to migrate the element backward to an older one. The commands available for all these script types are detailed on the following pages.

THE PROPERTIES SCRIPT

Library parts have a GDL window reserved for the Properties script. This script allows you to make library part properties dependent on parameters, and, through a directive, define their place in the final component list. By using a few commands, it is possible to define in the script local descriptors and components. Descriptors and components from external databases can also be referenced. Code lengths cannot exceed 32 characters.

In the Properties script, you can use any GDL command that does not generate a shape.

DATABASE_SET

```
DATABASE_SET set_name [, descriptor_name, component_name, unit_name, key_name,
                        criteria_name, list_set_name]
```

Database set definition or Database set selection. If this command is placed in a MASTER_GDL script, it will define a Database set containing Descriptor, Component, Unit, Key, Criteria and List Scheme files.

This Database set name can then be referenced from Properties Scripts using the same command with only the set_name parameter as a directive, by selecting the actual Database set that REF COMPONENTs and REF DESCRIPTORs refer to. The default Database set name is "Default Set", and will be used if no other set has been selected. The default Database set file names are: DESCDATA, COMPDATA, COMPUNIT, LISTKEY, LISTCRIT, LISTSET. All these names get translated in localized ARCHICAD versions.

Scripts can include any number of DATABASE_SET selections.

set_name: database set name.

descriptor_name: descriptor data file name.

component_name: component data file name.

unit_name: unit data file name.

key_name: key data file name.

criteria_name: criteria file name.

list_set_name: list Scheme file name.

DESCRIPTOR

DESCRIPTOR name [, code, keycode]

Local descriptor definition. Scripts can include any number of DESCRIPTORS.

name: can extend to more than one line. New lines can be defined by the character '\n' and tabulators by '\t'. Adding '\' to the end of a line allows you to continue the string in the next line without adding a new line. Inside the string, if the '\' character is doubled (\\), it will lose its control function and simply mean '\'. The length of the string (including the new line characters) cannot exceed 255 characters: additional characters will be simply cut by the compiler. If you need a longer text, use several DESCRIPTORS.

code: string, defines a code for the descriptor.

keycode: string, reference to a key in an external database.

The key will be assigned to the descriptor.

REF DESCRIPTOR

REF DESCRIPTOR code [, keycode]

Reference by code and keycode string to a descriptor in an external database.

COMPONENT

COMPONENT name, quantity, unit [, proportional_with, code, keycode, unitcode]

Local component definition. Scripts can include any number of COMPONENTS.

name: the name of the component (max. 128 characters).

quantity: a numeric expression.

unit: the string used for unit description.

proportional_with: a code between 1 and 6. When listing, the component quantity defined above will be automatically multiplied by a value calculated for the current listed element:

- 1: item,
- 2: length,
- 3: surface A,
- 4: surface B,
- 5: surface,

6: volume.

code: string, defines a code for the component.

keycode: string, reference to a key in an external database. The key will be assigned to the component.

unitcode: string, reference to a unit in an external database that controls the output format of the component quantity. This will replace the locally defined unit string.

REF COMPONENT

REF COMPONENT code [, keycode [, numeric_expression]]

Reference by code and keycode string to a component in an external database. The value to multiply by in the component database can be overwritten by the optional numeric expression specified here.

BINARYPROP

BINARYPROP

Binaryprop is a reference to the binary properties data (components and descriptors) defined in the library part in the Components and Descriptors sections.

DATABASE_SET directives have no effect on the binary data.

SURFACE3D

SURFACE3D ()

The Surface 3D () function gives you the surface of the 3D shape of the library part.

Warning: If you place two or more shapes in the same location with the same parameters, this function will give you the total sum of all shapes' surfaces.

VOLUME3D

VOLUME3D ()

The Volume 3D () function gives you the volume of the 3D shape of the library part.

Warning: If you place two or more shapes in the same location with the same parameters, this function will give you the total sum of all shapes' volumes.

POSITION

POSITION position_keyword

Effective only in the Component List.

Changes only the type of the element the following descriptors and components are associated to. If there are no such directives in the Properties script, descriptors and components will be listed with their default element types.

position_keyword: keywords are the following:

```

WALLS
COLUMNS
BEAMS
DOORS
WINDOWS
OBJECTS
CEILS
PITCHED_ROOFS
LIGHTS
HATCHES
ROOMS
MESHES

```

A directive remains valid for all succeeding DESCRIPTORS and COMPONENTs until the next directive is ascribed. A script can include any number of directives.

Example:

```

DESCRIPTOR "\tPainted box.\n\t Properties:\n\
\t\t - swinging doors\n\
\t\t - adjustable height\n\
\t\t - scratchproof"
REF DESCRIPTOR "0001"
s = SURFACE3D () !wardrobe surface
COMPONENT "glue", 1.5, "kg"
COMPONENT "handle", 2*c, "nb" !c number of doors
COMPONENT "paint", 0.5*s, "kg"
POSITION WALLS
REF COMPONENT "0002"

```

DRAWING

DRAWING

DRAWING: Refers to the drawing described in the 2D script of the same library part. Use it to place drawings in your bill of materials.

THE PARAMETER SCRIPT

Parameter lists are sets of possible numerical or string values. They can be applied to the parameters as defined in the Parameter Script of the Library Part, in the ARCHICAD_LibraryMaster object or the MASTER_GDL script. Type compatibility is verified by the GDL compiler.

The Parameter Script will be interpreted each time a value list type parameter value is to be changed, and the possible values defined in the script will appear in a pop-up menu. For numerical parameters pop-up menu item values can be defined as strings using the VALUES{2} command.

VALUES

```
VALUES "parameter_name" [,]value_definition1 [, value_definition2, ...]
VALUES "fill_parameter_name" [[,] FILLTYPES_MASK fill_types], value_definition1
    [, value_definition2, ...]
VALUES "profile_parameter_name" [[,] PROFILETYPES_MASK profile_types], value_definition1
    [, value_definition2, ...]
```

Defines a value restriction for a parameter (except dictionary types). The command has a special syntax for fill type and profile type parameters. If used on an array parameter, the restriction will be applied to all items individually.

parameter_name: name of an existing parameter

fill_parameter_name: name of an existing fillpattern type parameter

fill_types:

fill_types = $j_1 + 2*j_2 + 4*j_3$, where each j can be 0 or 1.

j_1 : cut fills,

j_2 : cover fills,

j_3 : drafting fills.

Can be used for fill-pattern type parameters only. The fill popup for this parameter will contain only those types of fills which are specified by the bits set to 1. Default is all fills (0).

profile_parameter_name: name of an existing profile type parameter

profile_types:

profile_types = $j_1 + 2*j_2 + 4*j_3 + 8*j_4 + 16*j_5$, where each j can be 0 or 1.

j_1 : wall,

j_2 : beam,

j_3 : column,

j_4 : handrail,

j_5 : other.

Can be set for profile type parameters only. The value list for any profile type parameter includes all existing profiles of the planfile automatically, no individual VALUES definition is needed. Using VALUES without masking (0) has the exact same result. Using VALUES with masking can filter the value list, leaving only the corresponding profiles of the bits set to 1. Individual profile indexes can be listed as regular value definitions as well.

value_definition_i: value definition, can be:

expression: numerical or string expression, or

CUSTOM: keyword, meaning that any custom value can be entered, or

RANGE: range definition, with optional step

RANGE left_delimiter[lower_limit], [upper_limit]right_delimiter [STEP step_start_value, step_value]

left_delimiter: [, meaning >=, or (, meaning >; lower_limit: lower limit expression; upper_limit: upper limit expression; right_delimiter:], meaning <=, or), meaning <; step_start_value: starting value; step_value: step value.

VALUES{2}

VALUES{2} "parameter_name" [,]num_expression1, description1,
[, num_expression2, description2, ...]

VALUES{2} "parameter_name" [,]num_values_array1, descriptions_array1
[, num_values_array2, descriptions_array2, ...]

parameter_name: name of an existing angle, length, real, or integer type parameter

num_expression_i, num_values_array_i: simple value definition for a numerical parameter, or array expression containing multiple numerical values. Available only for VALUES{2}

description_i, descriptions_array_i: description string of the numerical value *i*, or array expression containing multiple description strings of the values defined by num_values_array_i (array dimensions must match). Available only for VALUES{2}

Example 1: Simple value lists

```
VALUES "par1" 1, 2, 3
```

```
VALUES "par2" "a", "b"
```

```
VALUES "par3" 1, CUSTOM, SIN (30)
```

```
VALUES "par4" 4, RANGE(5, 10], 12, RANGE(,20] STEP 14.5, 0.5, CUSTOM
```

Example 2: Read all string values from a file for use in a value list

```

DIM sarray[]
! file in the library, containing parameter data
filename = "ProjectNotes.txt"
ch1 = OPEN ("text", filename, "MODE=RO, LIBRARY")
i = 1
j = 1
sarray[1] = ""
! collect all strings
DO
    n = INPUT (ch1, i, 1, var)
    IF n > 0 AND VARTYPE (var) = 2 THEN
        sarray[j] = var
        j = j + 1
    ENDIF
    i = i + 1
WHILE n > 0
CLOSE ch1
! parameter popup with strings read from the file
VALUES "RefNote" sarray

```

PARAMETERS

```

PARAMETERS name1 = expression1 [,
                name2 = expression2, ...,
                namen = expressionn]

```

name_i: the name of the parameter.

expression_i: the new value of the parameter.

Using this command, the parameter values of a Library Part can be modified by the Parameter Script.

The modification will only be effective for the next interpretation. Commands in macros refer to the caller's parameters. If the parameter is a value list, the value chosen will be either an existing value, the custom value, or the first value from the value list.

In addition, the global string variable GLOB_MODPAR_NAME contains the name of the last user-modified parameter.

LOCK

```

LOCK "name1" [, "name2", ..., "namen"]

```

Locks the named parameter(s) in the settings dialog box. A locked parameter will appear grayed in the dialog box and its value cannot be modified by the user.

namen: string expression, name of the parameter to be locked.

Compatibility: starting from ARCHICAD 22, the locking/hiding of selected ARCHICAD interface controls is extended.

The extended feature can be activated with "Enable hide/lock of specific fix named optional parameters" setting (see "Details/Compatibility Options" dialog of the object in the Library Part Editor). The extended selection contains fix named optional parameters corresponding to:

- standard text handling controls of "Text Style" settings dialog panel - see the section called "Parameters for Text Handling",
- extended label styling controls of "Text Style" settings dialog panel in Label tool - see the section called "Parameters for Labels",
- and selected label pointer controls of "Pointer" settings dialog panel - see the section called "Parameters for Labels".

LOCK ALL ["name1" [, "name2", ..., "namen"]]

Locks all parameters in the settings dialog box, except those listed after the ALL keyword.

HIDEPARAMETER

HIDEPARAMETER "name1" [, "name2", ..., "namen"]

Hides the named parameter(s) and its child parameters in the settings dialog box. A parameter hidden using this command in the parameter script will automatically disappear from the parameter list.

namen: string expression, name of the parameter to be hidden.

Compatibility: starting from ARCHICAD 22, the locking/hiding of selected ARCHICAD interface controls is extended. For details, see the LOCK command.

HIDEPARAMETER ALL ["name1" [, "name2", ..., "namen"]]

Hides all parameters and its child parameters in the settings dialog box, except those (and their children) listed after the ALL keyword.

THE USER INTERFACE SCRIPT

Using the following GDL commands, you can define a custom interface for a Library Part's Custom Settings panel in the settings dialog box. If you click the *Set as default* button in the Library Part editor, the custom interface will be used by default in the Object's (Door's, Window's, etc.) settings dialog box. Parameters with custom control are not hidden automatically on the original parameter list, but they can be hidden manually in the library part editor.

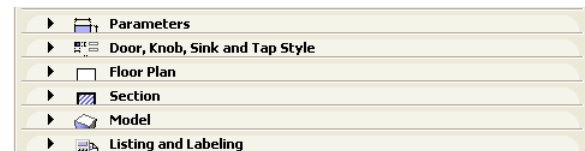
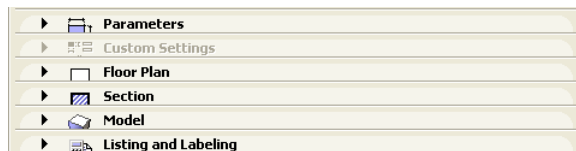

The origin of the coordinate system is in the top-left corner. Sizes and coordinate values are measured in pixels.

UI_DIALOG

UI_DIALOG title [, size_x, size_y]

Defines the title of the dialog box. The default title is 'Custom Settings'. Currently, the size of the available area is fixed at 444 x 296 pixels, and the size_x and size_y parameters are not used.

Restriction: The Interface Script should contain only one UI_DIALOG command.

UI_PAGE

UI_PAGE page_number [, parent_id, page_title [, image]]

Page directive, defines the page that the interface elements are placed on. Default page numbering starts at 1, but any starting number is usable. If there is no UI_PAGE command in the Interface Script, each element will be displayed on the first page by default. Moving between pages can be defined in different ways:

- The easiest way is to let ARCHICAD do it: in the object editor, press the "Hierarchical Pages" button in the User Interface Script window, and fill in the optional parameters of the UI_PAGE command. In this case the page_number of the page selected from the tree is passed to the library part through the "gs_ui_current_page" parameter. No need to set a value list for the paging parameter: ARCHICAD collects and sorts all valid page ID-s from the UI_PAGE command's parameters by pre-reading the object's ui script.
- Another method is to use two buttons created with the UI_NEXT and UI_PREV commands, placing them on every page to manipulate the value of the "gs_ui_current_page" parameter. See the UI_BUTTON command for more information.
- In case the new hierarchical page setup is not required, to create dynamic page handling, use the the UI_INFIELD {3} command. Set a value list for "gs_ui_current_page" parameter, and place a popup using its values on every page.

page_number: the page number, a positive integer. Following interface elements are placed on this page.

parent_id: positive integer, the parent id of the page. The special value -1 value means root parent. Only evaluated if "Hierarchical Pages" is set.

page_title: title string of the page, appears on the top of the page and the tree view popup of the pages. Only evaluated if "Hierarchical Pages" is set.

image: file name or index number of a picture stored in the library part. If specified and not empty or 0, this icon associated to the page is displayed on the top of the page and in tree view popup of the pages, next to the title. Only evaluated if "Hierarchical Pages" is set.

Warning: In the simple way of paging, any break of continuity in the page numbering forces the insertion of a new page without buttons, and therefore there will be no possibility to go to any other page from there. This restriction can be circumvented using the UI_CURRENT_PAGE command.

UI_CURRENT_PAGE

UI_CURRENT_PAGE index

Definition of the current tabpage to display.

Warning: Jumping to a non-existent page forces the insertion of a new page without buttons and controls, and therefore there is no possibility to go to any other page from there.

index: valid index of the UI_PAGE to display.

UI_BUTTON

UI_BUTTON type, text, x, y [, width, height, id [, url]]

Button definition on current page. Buttons can be used for various purposes: moving from page to page, opening a web page or performing some parameter-script defined action. Buttons can contain text.

type: type of the button as follows:

UI_PREV: if pressed, the previous page is displayed,

UI_NEXT: if pressed, the next page is displayed,

UI_FUNCTION: if pressed, the GLOB_UI_BUTTON_ID global variable is set to the button id specified in expression,

UI_LINK: if pressed, the URL in expression is opened in the default web browser,

text: the text that should appear on the button.

x, y: the position of the button.

width, height: width and height of the button in pixels. If not specified (for compatibility reasons) the default values are 60 pixels for width and 20 pixels for height.

id: an integer unique identifier.

url: a string containing a URL.

UI_PREV and UI_NEXT buttons are disabled if the previous/next page is not present. If these buttons are pushed, the gs_ui_current_page parameter of the library part is set to the index of the page to show - if there's a parameter with this name.

Example:

```
! UI script
UI_CURRENT_PAGE gs_ui_current_page
UI_BUTTON UI_FUNCTION, "Go to page 9", 200,150, 70,20, 3
UI_BUTTON UI_LINK, "Visit Website", 200,180, 100,20, 0,
    "https://www.graphisoft.com"
! parameter script
if GLOB_UI_BUTTON_ID = 3 then
    parameters gs_ui_current_page = 9, ...
endif
```

UI_PICT_BUTTON

UI_PICT_BUTTON *type*, *text*, *picture_reference*,
x, *y*, *width*, *height* [, *id* [, *url*]]

Similar to the UI_BUTTON command. But this type of buttons can contain pictures.

picture_reference: file name or index number of the picture stored in the library part. The index 0 refers to the preview picture of the library part. Pixel transparency is allowed in the picture.

text: has no effect for picture buttons.

UI_SEPARATOR

UI_SEPARATOR *x1*, *y1*, *x2*, *y2*

Generates a separator rectangle. The rectangle becomes a single (vertical or horizontal) separator line if $x1 = x2$ or $y1 = y2$

x1, **y1:** upper left node coordinates (starting point coordinates of the line).

x2, **y2:** lower right node coordinates (endpoint coordinates of the line).

UI_GROUPBOX

UI_GROUPBOX *text*, *x*, *y*, *width*, *height*

A groupbox is a rectangular separator with caption text. It can be used to visually group logically related parameters.

text: the title of the groupbox.

x, **y:** the position of upper left corner.

width, **height:** width and height in pixels.

UI_PICT

UI_PICT *picture_reference*, *x*, *y* [, *width*, *height* [, *mask*]]

Picture element in the dialog box. The picture file must be located in one of the loaded libraries.

picture_reference: file name or index number of the picture stored in the library part. The index 0 refers to the preview picture of the library part.

x, y: position of the top left corner of the picture.

width, height: optional width and height in pixels; by default, the picture's original width and height values will be used.

mask: alpha + distortion.

See the PICTURE command for full explanation.

UI_STYLE

UI_STYLE *fontsize*, *face_code*

All the UI_OUTFIELDS and UI_INFIELDS generated after this keyword will represent this style until the next UI_STYLE statement.

fontsize: one of the following font size values:

- 0: small,
- 1: extra small,
- 2: large.

face_code: similar to the DEFINE STYLE command, but the values cannot be used in combination.

- 0: normal,
- 1: bold,
- 2: italic,
- 4: underline.

UI_OUTFIELD

UI_OUTFIELD *expression*, *x*, *y* [, *width*, *height* [, *flags*]]

Generates a static text.

expression: numerical or string expression.

x, y: position of the text block's top left corner.

width, height: width and height of the text box. If omitted, the text box will wrap around the text as tight as possible for the given font.

flags:

flags = $j_1 + 2*j_2 + 4*j_3$, where each j can be 0 or 1.

j_1 : horizontal alignment (with j_2),

j_2 : horizontal alignment (with j_1):

$j_1 = 0, j_2 = 0$: Aligns to the left edge (default),

$j_1 = 1, j_2 = 0$: Aligns to the right edge,

$j_1 = 0, j_2 = 1$: Aligns to the center,

$j_1 = 1, j_2 = 1$: Not used,

j_3 : grayed text.

UI_INFIELD

```
UI_INFIELD "name", x, y, width, height [,
    method, picture_name,
    images_number,
    rows_number, cell_x, cell_y,
    image_x, image_y,
    expression_image1, text1,
    ...
    expression_imagen, textn]
```

UI_INFIELD{2}

```
UI_INFIELD{2} name, x, y, width, height [,
    method, picture_name,
    images_number,
    rows_number, cell_x, cell_y,
    image_x, image_y,
    expression_image1, text1,
    ...
    expression_imagen, textn]
```

UI_INFIELD{3}

```
UI_INFIELD{3} name, x, y, width, height [,
    method, picture_name,
    images_number,
    rows_number, cell_x, cell_y,
    image_x, image_y,
    expression_image1, text1, value_definition1,
    ...
    [picIdxArray, textArray, valuesArray,
    ...]
    expression_imagen, textn, value_definitionn]
```

UI_INFIELD{4}

```
UI_INFIELD{4} "name", x, y, width, height [,
    method, picture_name,
    images_number,
    rows_number, cell_x, cell_y,
    image_x, image_y,
    expression_image1, text1, value_definition1,
    ...
    [picIdxArray, textArray, valuesArray,
    ...]
    expression_imagen, textn, value_definitionn]
```

Generates an edit text or a pop-up menu for the parameter input. A pop-up is generated if the parameter type is value list, material, fill, line type or pencolor.

If the optional parameters of the command are present, value lists can be alternatively displayed as thumbnail view fields. Different thumbnail control types are available. They display the specified images and associated texts and allow the selection of one single item at a time, just like in a pop-up menu.

In the version 1 and 2 infield, the thumbnail items and the value list items are associated by indices.

The version 3 and version 4 infield defines value association which binds the thumbnail items to value list items of the associated parameter. If a value defined in a thumbnail item isn't present in the parameter's value list, it won't be displayed in the control. Identical sized arrays can be used for lines of definition as well.

The Interface Script is rebuilt with the new value after any parameter is modified.

name: parameter name as string expression (all 4 command versions), with parameter name option for UI_INFIELD{2} and UI_INFIELD{3}, and parameter name as text array value option for UI_INFIELD{4}.

x, y: the position of the edit text, pop-up or control.

width, height: width and height in pixels.

method: the type of the control.

1: List view control.



2: Popup menu control.

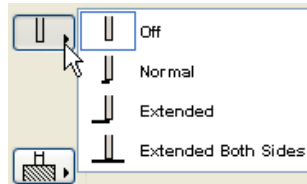

3: Popup icon radio control (arrow on picture).



4: Push icon radio control.



5: Pushbutton with text.

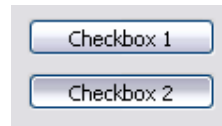

6: Pushbutton with picture.

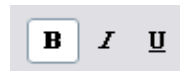

7: Checkbox with text.



8: Popup list with text.

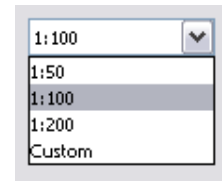

9: Popup icon radio control (arrow next to picture).



picture_name: name of the common image file containing a matrix of concatenated images, or empty string.

images_number: number of images in the matrix, for boolean parameters it can be 0 or 2.

rows_number: number of rows of the matrix.

cell_x, cell_y: width and height of a cell within the thumbnail view field, including image and text.

image_x, image_y: width and height of the image in the cell.

expression_image*i*: index of image number *i* in the matrix, or individual file name. If a common image file name was specified, indices must be used here. Combination of indices and individual file names does not work.

text*i*: text in cell number *i*.

value_definition*i*: value definition which matches the cell with a value list item by value:

expression: numerical or string expression, or

CUSTOM: keyword, meaning that any custom value can be entered.

picIdxArray: Dynamic array of picture names (strings) or indexes (integers) in cells. Do not use mixed types in array

textArray: Dynamic array of texts in cells

valueArray: Dynamic array of parameter values in cells

Example 1:

```

IF c THEN
  UI_DIALOG "Hole definition parameters"
  UI_OUTFIELD "Type of hole:",15,40,180,20
  UI_INFIELD "D",190,40,105,20
  IF d="Rectangular" THEN
    UI_PICT "rect.pict",110,33,60,30
    UI_OUTFIELD "Width of hole",15,70,180,20
    UI_INFIELD "E", 190,70,105,20
    UI_OUTFIELD "Height of hole",15,100,180,20
    UI_INFIELD "F", 190,100,105,20
    UI_OUTFIELD "Distance between holes",15,130,180,20
    UI_INFIELD "G", 190,130,105,20
  ELSE
    UI_PICT "circle.pict",110,33,60,30
    UI_OUTFIELD "Diameter of hole circle",15,70,180,20
    UI_INFIELD "J", 190,70,105,20
    UI_OUTFIELD "Distance of hole centers", 15,100,180,20
    UI_INFIELD "K", 190,100,105,20
    UI_OUTFIELD "Resolution of hole circle", 15,130,180,20
    UI_INFIELD "M", 190,130,105,20
  ENDIF
  UI_OUTFIELD "Number of holes",15,160,180,20
  UI_INFIELD "I", 190,160,105,20
ENDIF
UI_SEPARATOR 50,195,250,195
UI_OUTFIELD "Material of beam", 15,210,180,20
UI_INFIELD "MAT", 190,210,105,20
UI_OUTFIELD "Pen of beam", 15,240,180,20
UI_INFIELD "P", 190,240,105,20

```

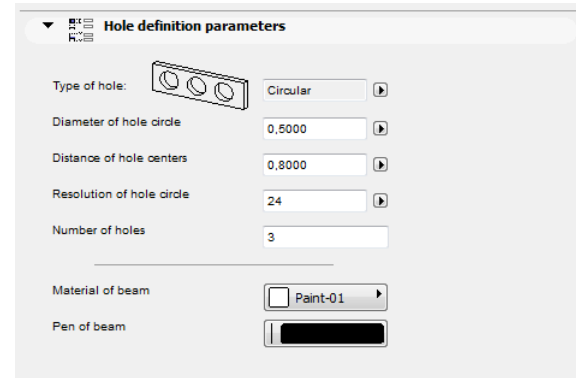
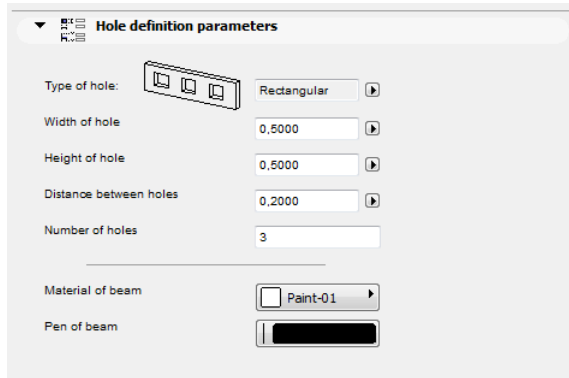

Example 2:

```
! Parameter Script:
VALUES "myParameter" "Two", "Three", "Five", CUSTOM
```

```
! Interface Script:
```

```
px = 80
py = 60
cx = px + 3
cy = py + 25
```

```
UI_INFIELD{3} "myParameter", 10, 10, 4 * cx + 21, cy + 5,
  1, "myPicture", 6,
  1, cx, cy, px, py,
  1, "1 - one", "One",
  2, "2 - two", "Two",
  3, "3 - three", "Three",
  4, "4 - four", "Four",
  5, "5 - five", "Five",
  6, "custom value", CUSTOM
```

Example 3:

```
! Parameter Script:
VALUES "myParameter" "Two", "Three", "Five", CUSTOM

! Interface Script:
px = 80
py = 60
cx = px + 3
cy = py + 25

paramNameVar = "myParameter"
UI_INFIELD{4} paramNameVar, 10, 10, 4 * cx + 21, cy + 5,
    1, "myPicture", 6,
    1, cx, cy, px, py,
    1, "1 - one", "One",
    2, "2 - two", "Two",
    3, "3 - three", "Three",
    4, "4 - four", "Four",
    5, "5 - five", "Five",
    6, "custom value", CUSTOM
```

Example 4:

```
! Master Script
dim picIdxValuesUI[]
dim textValuesUI[]
dim parameterValues[]

if myTypeParameter = 1 then
    picIdxValuesUI[1] = 6
    picIdxValuesUI[2] = 7
    picIdxValuesUI[3] = 8

    textValuesUI[1] = "6 - six"
    textValuesUI[2] = "7 - seven"
    textValuesUI[3] = "8 - eight"

    parameterValues[1] = "Six"
    parameterValues[2] = "Seven"
    parameterValues[3] = "Eight"
else
    picIdxValuesUI[1] = 6
    picIdxValuesUI[2] = 7

    textValuesUI[1] = "6 - six"
    textValuesUI[2] = "7 - seven"

    parameterValues[1] = "Six"
    parameterValues[2] = "Seven"
endif
```



```

! Parameter Script:
VALUES "myTypeParameter" 1, 2
VALUES "myStringParameter" "Two", "Three", "Five", parameterValues, CUSTOM

! Interface Script:
px = 80
py = 60
cx = px + 3
cy = py + 25

paramNameVar = "myStringParameter"
UI_INFIELD{4} paramNameVar, 10, 10, 4 * cx + 21, cy + 5,
    1, "myPicture", 6,
    1, cx, cy, px, py,
    1, "1 - one", "One",
    2, "2 - two", "Two",
    3, "3 - three", "Three",
    4, "4 - four", "Four",
    5, "5 - five", "Five",
    picIdxValuesUI, textValuesUI, parameterValues,
    9, "custom value", CUSTOM

```

UI_CUSTOM_POPUP_INFIELD

```

UI_CUSTOM_POPUP_INFIELD "name", x, y, width, height,
    storeHiddenId, treeDepth,
    groupingMethod, selectedValDescription,
    value1, value2, valuesArray1, .... valuen, valuesArrayn

```

UI_CUSTOM_POPUP_INFIELD{2}

```

UI_CUSTOM_POPUP_INFIELD{2} name, x, y, width, height,
    storeHiddenId, treeDepth,
    groupingMethod, selectedValDescription,
    value1, value2, valuesArray1, .... valuen, valuesArrayn

```

Compatibility: introduced in ARCHICAD 20.

Generates a popup for a value list of a parameter defined in the User Interface script to avoid using the Parameter script.

Suitable for lists which can not be requested in Parameter script. *For the parameter script restrictions see the section called "REQUEST Options".*

name: parameter name as string expression for UI_CUSTOM_POPUP_INFIELD or parameter name with optional actual index values if array for UI_CUSTOM_POPUP_INFIELD{2}.

x, y: the position of the edit text, pop-up.

width, height: width and height in pixels.

storeHiddenId, treeDepth: to set up automatic or manual trees.

storeHiddenId = 0, treeDepth = 0: works only with array parameters.

The "treeDepth" parameter is set automatically by the second dimension (number of columns) of the array.

storeHiddenId = 1, treeDepth > 0: works only with single parameters.

There must be $n * (1 + \text{treeDepth})$ values defined (first one for the stored ID and the rest for defining the custom tree).

groupingMethod: grouping method for sorting the tree.

1: does not sort the groups and values under the same parent.

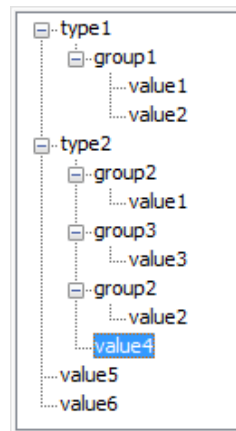

2: sorts the groups and values under the same parent.

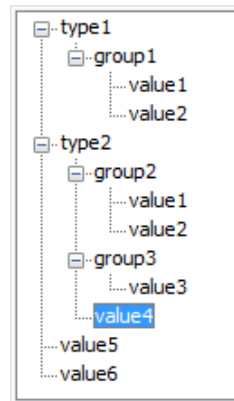

selectedValDescription: the text written in the field, if empty string the text will be the stored ID of the selected item.

valuei, valuesArrayi: define tree values one-by-one and/or with a one dimension array.

Example:

```

UI_CUSTOM_POPUP_INFIELD "stParameterName", x, y, width, height,
  1, 3, 2, "", ! storeHiddenId, treeDepth, groupingMethod, selectedValDescription
  "hiddenID1", "type1", "group1", "value1",
  "hiddenID2", "type1", "group1", "value2",
  "hiddenID3", "type2", "group2", "value1",
  "hiddenID4", "type2", "group2", "value2",
  "hiddenID5", "type2", "", "value3",
  "hiddenID6", "", "", "value4",
  "hiddenID7", "", "", "value5"

```

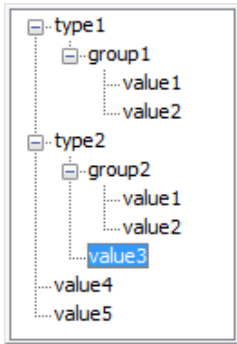

UI_RADIOBUTTON

UI_RADIOBUTTON name, value, text, x, y, width, height

UI_RADIOBUTTON{2}

UI_RADIOBUTTON{2} "name", value, text, x, y, width, height

Version {2} compatibility: introduced in ARCHICAD 20.

Generates a radio button of a radio button group. Radio button groups are defined by the parameter name. Items in the same group are mutually exclusive.

name: parameter name or name as string expression for **UI_RADIOBUTTON** and parameter name as string expression (or text array indexed value) for **UI_RADIOBUTTON{2}**.

value: parameter is set to this value if this radio button is set.

text: this text is displayed beside the radio button.

x, y: the position of the radio control.

width, height: width and height in pixels.

Example:

```

UI_RADIOBUTTON "ceilingPlan", 0, `Floor Plan`, 10, 140, 100, 20
UI_RADIOBUTTON "ceilingPlan", 1, `Ceiling Plan`, 10, 160, 100, 20
  
```

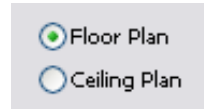

UI_PICT_RADIOBUTTON

UI_PICT_RADIOBUTTON name, value, text,
picture_reference, x, y, width, height [UI_TOOLTIP tooltip]

UI_PICT_RADIOBUTTON{2}

UI_PICT_RADIOBUTTON{2} "name", value, text,
picture_reference, x, y, width, height [UI_TOOLTIP tooltip]

Compatibility: introduced in ARCHICAD 22.

Generates one radio button with icon of a radio button group. Radio button groups are defined by the parameter name. Items in the same group are mutually exclusive.

name: parameter name or name as string expression for UI_PICT_RADIOBUTTON and parameter name as string expression (or text array indexed value) for UI_PICT_RADIOBUTTON{2}.

value: parameter is set to this value if this radio button is set.

text: this text is displayed on the button if no image is declared.

picture_reference: file name or index number of the picture stored in the library part. The index 0 refers to the preview picture of the library part. Pixel transparency is allowed in the picture.

x, y: the position of the radio control (top left anchor).

width, height: width and height of the button in pixels. Image size is not declared individually: it should fit the button, as image is not stretched automatically to fit, and is centered on the button.

UI_PICT_PUSHCHECKBUTTON

UI_PICT_PUSHCHECKBUTTON name, text, picture_reference,
frameFlag, x, y, width, height [UI_TOOLTIP tooltip]

UI_PICT_PUSHCHECKBUTTON{2}

UI_PICT_PUSHCHECKBUTTON{2} "name", text, picture_reference,
frameFlag, x, y, width, height [UI_TOOLTIP tooltip]

Compatibility: introduced in ARCHICAD 22.

Generates one pushcheck button with icon for a boolean parameter. Similar to the `UI_INFIELD{3}` command with method 6, with additional option to control the visibility of the button frame.

name: parameter name or name as string expression for `UI_PICT_PUSHCHECKBUTTON` and parameter name as string expression (or text array indexed value) for `UI_PICT_PUSHCHECKBUTTON{2}`.

text: this text is displayed on the button if no image is declared.

picture_reference: file name or index number of the picture stored in the library part. The index 0 refers to the preview picture of the library part. Pixel transparency is allowed in the picture.

frameFlag: 1 - frame is displayed, 0 - frame is not visible. Use this option to match the control to other User Interface items in style.

x, y: the position of the button (top left anchor).

width, height: width and height of the button in pixels. Image size is not declared individually: it should fit the button, as image is not stretched automatically to fit, and is centered on the button.

UI_TEXTSTYLE_INFIELD

```
UI_TEXTSTYLE_INFIELD name, faceCodeMask, x, y,
    buttonWidth, buttonHeight[, buttonOffsetX]
```

UI_TEXTSTYLE_INFIELD{2}

```
UI_TEXTSTYLE_INFIELD{2} "name", faceCodeMask, x, y,
    buttonWidth, buttonHeight [, buttonOffsetX]
```

Compatibility: introduced in ARCHICAD 22.

Generates a row of pushcheckbuttons specifically used to set font style via an integer parameter, with similar appearance as seen in the general program interface. The format of the set value matches the input parameter of the `DEFINE STYLE{2}` command. Both icons and tooltips are referenced from ARCHICAD itself, according to the localized version. The enabled buttons are displayed in a single-row arrangement.

name: parameter name or name as string expression for `UI_TEXTSTYLE_INFIELD` and parameter name as string expression (or text array indexed value) for `UI_TEXTSTYLE_INFIELD{2}`.

faceCodeMask: used bits add the matching font style option to the control:

$\text{faceCodeMask} = j_1 + 2*j_2 + 4*j_3 + 32*j_6 + 64*j_7 + 128*j_8$, where each j can be 0 or 1.

j_1 : bold,

j_2 : italic,

j_3 : underline,

j_6 : superscript,

`j7`: subscript,
`j8`: strikethrough.

If `faceCodeMask = 0`, then all possible font style buttons are displayed. In case of an invalid `faceCodeMask`, "Check Script" returns with warning ("Invalid mask value used").

x, y: the position of the first button (top left anchor).

buttonWidth, buttonHeight: width and height of one button in pixels. Full width can be calculated by using the `faceCodeMask`, the `buttonWidth` and the `buttonOffsetX` values, if necessary.

buttonOffsetX: distance between neighboring buttons in the row, in pixels. Automatic, if not set.

UI_LISTFIELD

UI_LISTFIELD `fieldID, x, y, width, height [, iconFlag [, description_header [, value_header]]]`

Generates a control for the parameter input as a scrollable list containing an arbitrary number of rows, with the following columns: icon, description and input field for the parameter value. Lines of the list can be defined with the `UI_LISTITEM` command. `UI_LISTFIELD` and `UI_LISTITEM` definitions can be scripted in an arbitrary order. Empty listfields (with no list items) are not displayed.

fieldID: the unique identifier of the listfield. This ID also used in the `UI_LISTITEM` commands specifies the listfield the listitems belong to. Duplicates within a user interface script are not allowed.

x, y: position of the listfield's top left corner.

width, height: width and height in pixels.

iconFlag:

`iconFlag = 0`: icon column is not generated for this listfield.

`iconFlag = 1`: icon column is generated for this listfield (default value if not specified).

If the Custom Settings panel has only one control and this control is a listfield, the `x, y, width, height` parameters have no effect. In this case the width of the listfield equals to the width of the Custom Settings panel.

description_header: the title of the Description column.

value_header: the title of the Value column.

If both `description_header` and `value_header` are empty strings or not specified, the listfield is generated without a header. If the strings contain at least one space, the listfield is generated with an empty header.

UI_LISTITEM

UI_LISTITEM `itemID, fieldID, "name" [, childFlag [, image [, paramDesc]]]`

UI_LISTITEM{2}

UI_LISTITEM{2} itemID, fieldID, name [, childFlag [, image [, paramDesc]]]

Appends a listitem to the listfield defined by the fieldID parameter.

itemID: the unique identifier of the listitem. Listitems can be scripted in an arbitrary order and are sorted by itemID. Duplicate listitem IDs within a listfield are not allowed.

fieldID: the unique identifier of the listfield containing this listitem.

name: parameter name as string expression for UI_LISTITEM or parameter name with optional actual index values if array for UI_LISTITEM{2}.

childFlag:

childFlag = 0: the listitem is a groupitem (default value if not specified).

childFlag = 1: the listitem is a childitem. The parent item is the first groupitem above.

image: file name or index number of the picture stored in the library part. If valid, it is displayed as an icon in the first column of the listfield in the associated listitem's row.

paramDesc: the visible name of the listitem in the Description column. If left empty, the description is automatically filled up from the parameter list description of the Library Part. If there is no description there, the name of the parameter is displayed instead.

If "name" string is empty, the listitem is a group with bold fonttype. If both "name" string and paramDesc are empty, the listitem is a separator. The HIDEPARAMETER command is ineffective for list items, the script should not add the item instead of using it. The LOCK command can be used and it is effective for list items.

For a listfield it is recommended to define different itemIDs for different parameters, groups and separators.

Example:

! List with header without icon column

```
ui_listfield 1, 10, 35, 432, 220, 0, "Description Header Text", "Value Header Text"
```

```
ui_listitem 1, 1, "", 0, "", "Group Title 1" ! Group Line
```

```
ui_listitem 2, 1, "A", 1
```

```
ui_listitem 3, 1, "B", 1
```

```
ui_listitem 4, 1, "ZZYZX", 1
```

```
ui_listitem 5, 1, "" !separator
```

```
ui_listitem 6, 1, "AC_show2DHotspotsIn3D", 0, "", "Group Title 2" ! Group Parameter Line
```

```
ui_listitem 7, 1, "A", 1, "", "Custom Description A"
```

```
ui_listitem 8, 1, "B", 1, "", "Custom Description B"
```

```
ui_listitem 9, 1, "ZZYZX", 1, "", "Custom Description ZZYZX"
```

Description Header Text	Value Header Text
▼ Group Title 1	
Dimension 1	1000
Dimension 2	1000
Height	1000
▼ Group Title 2	☑
Custom Description A	1000
Custom Description B	1000
Custom Description ZZYZX	1000

UI_CUSTOM_POPUP_LISTITEM

```
UI_CUSTOM_POPUP_LISTITEM itemID, fieldID, "name", childFlag, image, paramDesc,
storeHiddenId, treeDepth,
groupingMethod, selectedValDescription,
value1, value2, valuesArray1, .... valuen, valuesArrayn
```

UI_CUSTOM_POPUP_LISTITEM{2}

```
UI_CUSTOM_POPUP_LISTITEM{2} itemID, fieldID, name, childFlag, image, paramDesc,
storeHiddenId, treeDepth,
groupingMethod, selectedValDescription,
value1, value2, valuesArray1, .... valuen, valuesArrayn
```

Compatibility: introduced in ARCHICAD 20.

Similar to the "UI_CUSTOM_POPUP_INFIELD" and the "UI_CUSTOM_POPUP_INFIELD{2}"

Generates a listitem with popup for a value list of a parameter defined in the User Interface script to avoid using the Parameter script.

Suitable for lists which can not be requested in Parameter script. *For the parameter script restrictions see the section called "REQUEST Options".*

itemID: the unique identifier of the listitem. Listitems can be scripted in an arbitrary order and are sorted by itemID. Duplicate listitem IDs within a listfield are not allowed.

fieldID: the unique identifier of the listfield containing this listitem.

name: parameter name as string expression for UI_CUSTOM_POPUP_LISTITEM or parameter name with optional actual index values if array for UI_CUSTOM_POPUP_LISTITEM{2}.

childFlag:

childFlag = 0: the listitem is a groupitem (default value if not specified).

childFlag = 1: the listitem is a childitem. The parent item is the first groupitem above.

image: file name or index number of the picture stored in the library part. If valid, it is displayed as an icon in the first column of the listfield in the associated listitem's row.

paramDesc: the visible name of the listitem in the Description column. If left empty, the description is automatically filled up from the parameter list description of the Library Part. If there is no description there, the name of the parameter is displayed instead.

storeHiddenId, treeDepth: to set up automatic or manual trees.

storeHiddenId = 0, treeDepth = 0: works only with array parameters.

The "treeDepth" parameter is set automatically by the second dimension (number of columns) of the array.

storeHiddenId = 1, treeDepth > 0: works only with single parameters.

There must be $n * (1 + \text{treeDepth})$ values defined (first one for the stored ID and the rest for defining the custom tree).

groupingMethod: grouping method for sorting the tree.

1: does not sort the groups and values under the same parent.

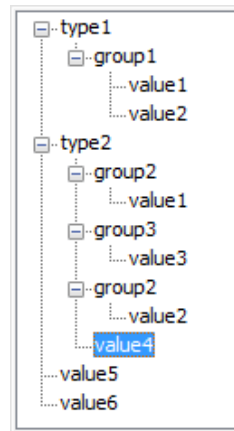

2: sorts the groups and values under the same parent.

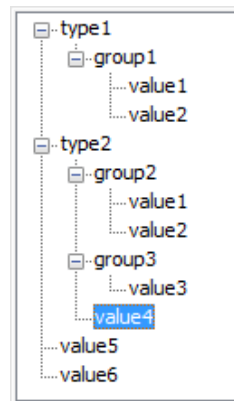

selectedValDescription: the text written in the field, if empty string the text will be the stored ID of the selected item.

value_i, valuesArray_i: define tree values one-by-one and/or with a one dimension array.

Example:

```
UI_CUSTOM_POPUP_LISTITEM itemID, fieldID, "stParameterName", 0, "", "",
1, 3, 2, "", ! storeHiddenId, treeDepth, groupingMethod, selectedValDescription
"hiddenID1", "type1", "group1", "value1",
"hiddenID2", "type1", "group1", "value2",
"hiddenID3", "type2", "group2", "value1",
"hiddenID4", "type2", "group2", "value2",
"hiddenID5", "type2", "", "value3",
"hiddenID6", "", "", "value4",
"hiddenID7", "", "", "value5"
```

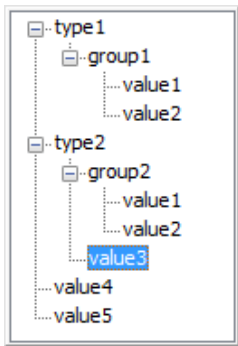

UI_TOOLTIP

```
UI_BUTTON type, text, x, y, width, height [, id [, url]] [ UI_TOOLTIP tooltiptext ]
UI_PICT_BUTTON type, text, picture_reference,
x, y, width, height [, id [, url]] [ UI_TOOLTIP tooltiptext ]
UI_INFIELD "name", x, y, width, height [, extra parameters ... ]
[ UI_TOOLTIP tooltiptext ]
UI_INFIELD{2} name, x, y, width, height [, extra parameters ... ]
[ UI_TOOLTIP tooltiptext ]
UI_INFIELD{3} name, x, y, width, height [, extra parameters ... ]
[ UI_TOOLTIP tooltiptext ]
UI_INFIELD{4} "name", x, y, width, height [, extra parameters ... ]
[ UI_TOOLTIP tooltiptext ]
```

```

UI_CUSTOM_POPUP_INFIELD "name", x, y, width, height , extra parameters ...
    [ UI_TOOLTIP tooltiptext ]
UI_CUSTOM_POPUP_INFIELD{2} name, x, y, width, height , extra parameters ...
    [ UI_TOOLTIP tooltiptext ]
UI_RADIOBUTTON name, value, text, x, y, width, height [ UI_TOOLTIP tooltiptext ]
UI_OUTFIELD expression, x, y, width, height [, flags] [ UI_TOOLTIP tooltiptext ]
UI_PICT expression, x, y [, width, height [, mask]] [ UI_TOOLTIP tooltiptext ]
UI_LISTFIELD fieldID, x, y, width, height [, iconFlag [, description_header [, value_header]]]
    [ UI_TOOLTIP tooltiptext ]
UI_LISTITEM itemID, fieldID, "name" [, childFlag [, image [, paramDesc]]]
    [ UI_TOOLTIP tooltiptext ]
UI_LISTITEM{2} itemID, fieldID, name [, childFlag [, image [, paramDesc]]]
    [ UI_TOOLTIP tooltiptext ]
UI_CUSTOM_POPUP_LISTITEM itemID, fieldID, "name", childFlag , image , paramDesc,
    extra parameters ...
    [ UI_TOOLTIP tooltiptext ]
UI_CUSTOM_POPUP_LISTITEM{2} itemID, fieldID, name, childFlag , image , paramDesc,
    extra parameters ...
    [ UI_TOOLTIP tooltiptext ]

```

Defines the tooltip for the control on the user interface page. Tooltips are available for buttons, infields, outfields, listfields, listitems and pictures if they are not disabled by the user in the running context (e.g, in the Help menu of ARCHICAD).

The listfield's tooltip appears in all included listitems if an item has none declared. The own tooltip of the listitem will take effect over the tooltip of the listfield (if existing) inline.

tooltiptext: the text to display as tooltip for the control.

UI_COLORPICKER

```

UI_COLORPICKER "redParamName", "greenParamName", "blueParamName", x0, y0 [, width [, height]]

```

UI_COLORPICKER{2}

```

UI_COLORPICKER{2} redParamName, greenParamName, blueParamName, x0, y0 [, width [, height]]

```

Color picker dialog to set the r, g, b components of a color and store them into the given parameters. These values can later be used in the LIGHT command.

redParamName, greenParamName, blueParamName: parameter names as string expression for UI_COLORPICKER or parameter names with optional actual index values if array for UI_COLORPICKER{2}

x0, y0: position of the color picker's top left corner.

width, height: width and height in pixels.

UI_SLIDER

UI_SLIDER "name", x0, y0, width, height [, nSegments [, sliderStyle]]

UI_SLIDER{2}

UI_SLIDER{2} name, x0, y0, width, height [, nSegments [, sliderStyle]]

Generates a slider control for an integer parameter defined with a range. For integer parameters with undefined range lower and upper limit values are -32768 (minimum signed short) and 32767 (maximum signed short).

name: parameter name as string expression parameter or name with optional actual index values for UI_SLIDER{2}.

x0, y0: position of the slider.

width, height: slider width and height in pixels. If the width > height the slider is horizontal, in the opposite case it is vertical.

nSegments: optional number of segments on the slider. If 0, no segments are displayed, if omitted or negative, the number of segments are calculated from the range upper and lower limit values and the step defined for the parameter.

sliderStyle: optional slider style (default is 0)

0: slider points to the bottom (horizontal sliders) or to the right (vertical sliders).

1: slider points to the top (horizontal sliders) or to the left (vertical sliders).

THE FORWARD MIGRATION SCRIPT

If an element is changed completely in a newer library, compatibility can be maintained by defining the migration logic. For more detailed information, please take a look at the section called "Forward Migration script".

Example:

```

actualGUID = FROM_GUID

! =====
! Subroutines
! =====

    _startID    = "AAAA-AAAA-...AAA"
    _endID      = "BBBB-BBBB-...BBB"
gosub "migrationstepname_FWM"

! =====
! Set Migration GUID
! =====

setmigrationguid actualGUID

! =====
end ! end ! end ! end ! end ! end ! end ! end ! end ! end ! end ! end ! en
! =====

! =====
! migrationstepname
! =====
"migrationstepname_FWM":
    if actualGuid = _startID then
        newParameter = oldParameter
        parameters newParameter = newParameter
        actualGuid = _endID
    endif
return

```

FROM_GUID is the global variable holding the main ID of the original object which the migration is run on. In case the script succeeds, the instance gets substituted by the new element with the updated parameters.

SETMIGRATIONGUID

SETMIGRATIONGUID guid

The command tells the running environment, which element will be the matching migration element for the current object. If the returned ID belongs to the current element, the migration of the object gets complete.

STORED_PAR_VALUE

STORED_PAR_VALUE ("oldparname", outputvalue)

Retrieves the value of a parameter, which is present in the migrated object, and present or deleted in the new version object. This command form is suggested for those parameters present in the new object as well. To get the value of an old array Parameter, the outputvalue parameter must be initialized as an array (with the dim command).

oldparname: string expression, name of the parameter in the old parameter list.

outputvalue: output variable to store the value of the parameter.

Return value: 1 on success, 0 otherwise (for example, if there is no parameter with that name in the parameter list of the old object). During checking the script the return value is always 0, because the old Parameters section is not known.

DELETED_PAR_VALUE

DELETED_PAR_VALUE ("oldparname", outputvalue)

Retrieves the value of a parameter, which is present in the migrated object, and present or deleted in the new version object. This command form is suggested for those parameters deleted from the new object. To get the value of an old array Parameter, the outputvalue parameter must be initialized as an array (with the dim command).

oldparname: string expression, name of the parameter in the old parameter list.

outputvalue: output variable to store the value of the parameter.

Return value: 1 on success, 0 otherwise (for example, if there is no parameter with that name in the parameter list of the old object). During checking the script the return value is always 0, because the old Parameters section is not known.

THE BACKWARD MIGRATION SCRIPT

Via the Backward Migration script you can define the backward conversion logic converting new object instances to older ones. For more and detailed information, please take a look at the section called "Backward Migration script".

Example:

```
targetGUID = TO_GUID

! =====
! Subroutines
! =====

gosub "migrationstepname_BWM"

! =====
! Set Migration GUID
! =====

setmigrationguid targetGUID

! =====
end ! end ! end ! end ! end ! end ! end ! end ! end ! end ! end ! end ! en
! =====

! =====
! migrationstepname
! =====
"migrationstepname_BWM":
  if targetGUID # "" then
    bMigrationSuccess = 1
    if bMigrationSuccess = 1 then
      oldParameter = newParameter
      parameters oldParameter = oldParameter
    else
      targetGuid = ""
    endif
  endif
return
```

TO_GUID is the global variable holding the main ID of the target element in the conversion.
Use the SETMIGRATIONGUID command for setting targetGUID.

NEWPARAMETER

NEWPARAMETER "name", "type" [, dim1 [, dim2]]

Adds a new parameter to the parameters of a library part in the Backward Migration Script. The parameter creation happens only after the full interpretation of the script. If a parameter with the given name already exists in the parameters list, an error occurs.

name: string expression, name of the parameter to be created.

type: string expression, type of the parameter. Possible values are:

- Integer
- Length
- Angle
- RealNum
- LightSwitch
- ColorRGB
- Intensity
- LineType
- Material
- FillPattern
- PenColor
- String
- Boolean
- BuildingMaterial(*Compatibility: introduced in ARCHICAD 22.*)
- Profile(*Compatibility: introduced in ARCHICAD 22.*)

dim1, dim2: dim1 is the first dimension of the parameter, 0 if not set. dim2 is the second dimension of the parameter, 0 if not set.

- dim1 = 0, dim2 = 0: the parameter is a scalar parameter,
- dim1 > 0, dim2 = 0: the parameter is a 1 dimensional array,
- dim1 > 0, dim2 > 0: the parameter is a 2 dimensional array,

Restriction of parameters:

If dim2 > 0, then dim1 > 0.

EXPRESSIONS AND FUNCTIONS

All parameters of GDL shapes can be the result of calculations. For example, you can define that the height of the cylinder is five times the radius of the cylinder, or prior to defining a cube, you can move the coordinate system in each direction by half the size of the cube, in order to have the initial origin in the center of the cube rather than in its lower left corner. To define these calculations, GDL offers a large number of mathematical tools: expressions, operators and functions.

EXPRESSIONS

You can write compound expressions in GDL statements. Expressions can be of numerical and string type. They are constants, variables, parameters or function calls and any combination of these in operators. Round bracket pairs `(())` (precedence 1) are used to override the default precedence of the operators.

Simple type variables can be given numerical and string values, even in the same script, and can be used in numerical and string type expressions respectively. Operations resulting in strings CANNOT be used directly as macro names in macro calls, or as attribute names in material, fill, line type or style definitions. Variables given a string value will be treated as such and can be used wherever string values are required. If later in the script the same variable is given a numerical value, it will be usable in numerical expressions only until it is given a string value again. Where possible, in the precompilation process the type of the expressions is checked.

DICT

DICT `variableName1[, variableName2...]`

Compatibility: introduced in ARCHICAD 23.

GDL supports dictionaries. A variable is declared as a dictionary after the above declaration statement (and cannot be changed to array or simple type or vice versa). Library part parameters can also be dictionaries, by selecting Dictionary type in the parameter list.

After the DICT keyword there can be any number of variable names separated by commas. Each variable will contain hierarchical key and value pairs. A key of the dictionary can be referenced with dot notation. The full path of a key cannot be longer than 255 characters (counting array indices as one character).

Dictionaries and simple type values:

- simple type (string, integer, floating-point) values can be assigned to dictionary keys,
- no declaration is necessary, the value type for the key is set by the current value:

```

DICT myDictionary

```

```

myDictionary.element1 = 1
myDictionary.element1 = "hello"

```

```

print myDictionary

```

Dictionaries and derived type values:

- a dictionary can nest array type (with one dimension only) and dictionary type keys,
- an array inside a dictionary can contain unnamed dictionary or simple types (referenced by the index),
- however, a standalone array type parameter/variable cannot contain dictionary type elements,
- a nested array key can be initialized by referencing it right away, no need to declare with DIM in this case,

```

DICT myDictionary
myDictionary.myArray[1] = 1
myDictionary.myArray[2] = 5

```

```

print myDictionary

```

- unreferenced indexes of a nested array are automatically initialized according to the type of the first referenced element of the array (string keys to "", numerical keys to 0, dictionary keys to {}),

```

DICT myDictionary
DICT dictForNesting
dictForNesting.elem1 = "hello"
dictForNesting.elem2 = "world"

```

```

myDictionary.myArray[2] = dictForNesting

```

```

print myDictionary

```

```

DICT myDictionary2
myDictionary2.myArray[3] = 33
myDictionary2.myArray[4] = 44

```

```

print myDictionary2

```

- the values of a nested array has to be of the same type (all string, all integer, all floating-point or all dictionary types), this is contrary to how arrays work, so extra caution is needed!

```

DICT myDictionary2
myDictionary2.myArray[1] = 1
myDictionary2.myArray[2] = 1.0 ! GDL error

```

- to change the value types of a nested array, it needs to be reset first: create an empty array, and overwrite the nested array with this new empty array. The type of the next referenced value will set the type for the array after the reset automatically:

```

DICT myDictionary
myDictionary.myArray[1] = "hello"
print myDictionary

DIM arrayForReset[]
myDictionary.myArray = arrayForReset
print myDictionary

```

```

myDictionary.myArray[1] = 10000
print myDictionary

```

- changing the type of the first value of a nested array containing that value only, will not change the type of the array!

```

DICT myDictionary
myDictionary.myArray[1] = "hello"
print myDictionary

myDictionary.myArray[1] = 10000 ! GDL error
print myDictionary

```

Initialization and copying:

- the first reference of the dictionary has to be `DICT dictName`, a subroutine containing the name of the dictionary can not precede it (same as with DIM arrays),
- initialization is required before the first use of a key, either explicitly with assignment to the key, or implicitly with assigning a dictionary that contains the key at the right depth.

```

DICT myDictionary

myDictionary.level1.a = 1
myDictionary.level1.b = 2
myDictionary.level2 = myDictionary.level1

print myDictionary.level2.b

```

- writing the dictionary name without actual inner keys references the whole dictionary structure, which is accepted in some cases (`CALL`, `PRINT`, `LET` statements),
- writing part of the structure references the subtree below that key as a dictionary

```

DICT myDictionary
myDictionary.point1.x = 1
myDictionary.point1.y = 1
myDictionary.point1.type = 0
print myDictionary

```

```

DICT myPoint
myPoint = myDictionary.point1
print myPoint

```

```

myDictionary.point2 = myDictionary.point1
print myDictionary

```

- assigning all or part of a dictionary makes a deep copy of the right-hand side on the left-hand side

```

DICT myDictionary, tempPoint
tempPoint.x = 1
tempPoint.y = 1
myDictionary.line.point1 = tempPoint

```

```

tempPoint.x = 2
tempPoint.y = 2
myDictionary.line.point2 = tempPoint

```

```

DICT myLine
myLine = myDictionary.line
myDictionary.line.point2.x = 0
print myLine

```

Macro calls and requests:

- in macro calls, dictionary type values can be sent to the macro if there is a dictionary type parameter on the receiving end,
- RETURNED_PARAMETERS can work with dictionaries: an empty DICT has to be declared on the receiving end (caller object). In the following code myDictionary is a dict type parameter in the macro, _myDictionary is a dict type variable on the caller object side:

```

! caller object Master script
DICT _myDictionary

_myDictionary.element1 = 1
_myDictionary.element2 = 2

DICT _dictForReceivedData

call "macroname" parameters all myDictionary = _myDictionary,
    returned_parameters _dictForReceivedData

print _dictForReceivedData

! in the macro object Master script
myDictionary.element1 = myDictionary.element1 * 2
myDictionary.element2 = myDictionary.element2 * 2

end myDictionary

```

- in REQUEST options currently there is no request supporting dictionaries. However, the possibility is open for the future.
- LIBRARYGLOBAL requests cannot return dictionary type values.

Visualization and functions:

- dictionary type parameters are not visible on "All Parameters" page in the "Settings" dialog,
- dictionary type parameters are not available for Listing display or IFC mappings,
- text-like visualization works only with the PRINT command ("Check Script" warning and printed to Report window in JSON format),
- general text handling commands like TEXT2, RICHTEXT2, etc. are not supporting the complete dictionary,
- however, nested non-dictionary type values can be displayed with them,

```

DICT myDictionary
myDictionary.myArray[1] = "hello"
myDictionary.myArray[2] = "world"

text2 0, 0, myDictionary.myArray[1] + " " + myDictionary.myArray[2]
print myDictionary

```

- values for a dictionary type parameter can only be set via the Parameter script (no direct user input is available through Parameter list or UI controls), the VALUES command is disabled for this type,

- however, using non-dictionary parameters for user input can work. In the following code, `myDictionary` is a dictionary type parameter, `stTextInput` is a string type parameter (which can be used in User Interface, displayed on the "All Parameters" page, and works together with `GLOB_MODPAR_NAME`):

```
! in Parameter Script
myDictionary.text1 = stTextInput
parameters myDictionary = myDictionary

! in Master Script
print myDictionary

! in 2D script
TEXT2 0, 0, myDictionary.text1
```
- value replacement using the `LP_XMLConverter` tool is currently unavailable for dictionary type parameters.

HASKEY

HASKEY (dictionary.key)

Returns as a boolean whether key has been previously defined in dictionary (key can include sub-keys).

Example:

```
DICTIONARY myDictionary
myDictionary.point[1].x = 1
myDictionary.point[1].y = 1

print HASKEY(myDictionary.point)           ! true
print HASKEY(myDictionary.point[2])       ! false
print HASKEY(myDictionary.point[1].z)     ! false
```

REMOVEKEY

REMOVEKEY (dictionary.key)

The function removes the referred key from the dictionary, along with the assigned value(s). If the removal was successful, the return value is 1, otherwise 0 (in case the key is non-existent or already deleted).

Example:

```

DICT myDictionary
myDictionary.myText[1] = "hello"
myDictionary.myOtherText[1] = "world"

print myDictionary

_dummy = REMOVEKEY(myDictionary.myOtherText)
print myDictionary, _dummy

_dummy2 = REMOVEKEY(myDictionary.myNonExistentText)
print myDictionary, _dummy2

```

DIM

```

DIM var1[dim_1], var2[dim_1][dim_2], var3[ ],
    var4[ ][ ], var5[dim_1][ ],
    var5[ ][dim_2]

```

GDL supports one and two dimensional arrays. Variables become arrays after the above declaration statement, in which their dimensions are specified. (Dictionary type variables cannot be redeclared as arrays or vice versa.)

After the DIM keyword there can be any number of variable names separated by commas. var1, var2, ... are the array names, while the numbers between the brackets represent the dimensions of the array (numerical constants). Variable expressions cannot be used as dimensions. If they are missing, the array is declared to be dynamic (one or both dimensions).

Library part parameters can also be arrays. Their actual dimensions are specified in the library part dialog. Parameter arrays do not have to be declared in the script and they are dynamic by default. When referencing the library part using a CALL statement, the actual values of an array parameter can be an array with arbitrary dimensions.

The elements of the arrays can be referenced anywhere in the script but if they are variables, only after the declaration.

```

var1[num_expr] or var1
var2[num_expr1][num_expr2] or var2[num_expr1] or var2

```

Writing the array name without actual indices means referencing the whole array (or a line of a two-dimensional array) which is accepted in some cases (CALL, PRINT, LET, PUT, REQUEST, INPUT, OUTPUT, SPLIT statements). For dynamic arrays there is no limitation for the actual index value. During the interpretation, when a non-existing dynamic array element is given a value, the necessary quantity of memory is allocated and the missing elements are all set to 0 (numerical).

Warning! This may cause an unexpected out of memory error in some cases. Each index - even of a possibly wrong, huge value - is considered valid, since the interpreter is unable to detect the error condition. A non-existing dynamic array element is 0 (numerical).

Arrays having a fixed dimension are checked for the validity of the actual index on the fixed dimension. Array variables with fixed length cannot accept dynamic array values in assignments. However, dynamic arrays that are given whole array values will take on those values. This also applies to some statements where whole array references can be used as return parameters. (REQUEST, INPUT, SPLIT).

Array elements can be used in any numerical or string expression. They can be given string or numerical values.

Indices start with 1, and any numerical expression can be used as an index.

Array elements can be of different simple types (numerical, string, group). The type of the whole array (main type) is the type of its first element ([1] or [1][1]). Parameter and global variable arrays cannot be of mixed type.

VARDIM1

VARDIM1 (expr)

VARDIM2

VARDIM2 (expr)

These functions return as integers the actual dimension values for the (array) expression specified as a parameter. They must be used if you want to handle correctly all actual elements of a dynamic array or an array parameter. If no element of a dynamic array was previously set, the return value is 0. For one-dimensional arrays VARDIM2 returns 0.

Example 1: Examples for numeric expressions:

```
Z
5.5
(+15)
-x
a*(b+c)
SIN(x+y)*z
a+r*cos(i*d)
5' 4"
SQR (x^2 + y^2) / (1 - d)
a + b * sin (alpha)
height * width
```

Example 2: Examples for string expressions:

```
"Constant string"
name + STR ("%m", i) + "." + ext
string_param <> "Mode 1"
```

Example 3: Examples for expressions using array values:

```
DIM tab[5], tab2[3][4] ! declaration
tab[1] + tab[2]
tab2[2][3] + A
PRINT tab
DIM f1 [5], v1[], v2[][]
v1[3] = 3      ! v1[1] = 0, v1[2] = 0, array of 3 elements
v2[2][3] = 23 ! all other elements (2 X 3) = 0
PRINT v1, v2
DIM f1 [5], v1[], v2[][]
FOR i = 1 TO VARDIM1(f1)
    f1[i] = i
NEXT i
v1 = f1
v2 [1] = f1
PRINT v1, v2
```

Example 4: Examples for expressions using dictionary values:

```

DICT _exampleDict

! DICT simple key types

_exampleDict.false = (1 = 2) ! logical false (integer internally)
_exampleDict.true = (1 = 1) ! logical true (integer internally)
_exampleDict.int = 2 ! integer
_exampleDict.float = 1 / 3 ! floating-point
_exampleDict.string = "Custom text" ! string

! DICT array key type

! initialize array on-the-fly
_exampleDict.array[1] = _exampleDict.float
! append to array on-the-fly
_exampleDict.array[2] = _exampleDict.float * 2
! append to array with automatic initialization of elements in between
_exampleDict.array[4] = _exampleDict.float * 3

! DICT array of DICTs

DIM array[]
DICT _element
_element.a = "A"
_element.b = 1

_exampleDict.array = array ! change existing array to empty one
_exampleDict.array[2] = _element ! different vartype than previous

! print DICT array of DICTs
print "\n\t",
"Print DICT array of DICTs",
"\n-----\n\t",
vartype(_exampleDict.array), vardim1(_exampleDict.array), "\n",
_exampleDict.array,
"\n-----"

```

PARVALUE_DESCRIPTION

PARVALUE_DESCRIPTION (parname [, ind1 [, ind2]])

This function returns the parameter value description string of a numerical parameter specified using the VALUES command statement. If no description is specified, the returned value is an empty string.

parname: name of the parameter

ind1, ind2: actual indices if the parameter is an array.

OPERATORS

The operators below are listed in order of decreasing precedence. The evaluation of an expression begins with the highest precedence operator and from left to right.

Arithmetical Operators

^ (or **)	Power of	precedence 2
*	Multiplication	precedence 3
/	Division	precedence 3
MOD (or %)	Modulo (remainder of division) $x \text{ MOD } y = x - y * \text{INT}(x/y)$	precedence 3
+	Addition	precedence 4
-	Subtraction	precedence 4

Note

+ (addition) can also be applied to string expressions: the result is the concatenation of the strings. The result of the '/' (Division) is always a real number, while the result of the other operations depends on the type of the operands: if all operands are integer, the result will be integer, otherwise real.

Relational Operators

=	Equal	precedence 5
<	Less than	precedence 5
>	Greater than	precedence 5
<=	Less than or equal	precedence 5
>=	Greater than or equal	precedence 5
<> (or #)	Not equal	precedence 5

Note

These operators can be used between any two string expressions also (string comparison is case sensitive). The result is an integer, 1 or 0. There is not recommended to use the '=' (Equal), '<=' (Less than or equal), '>=' (Greater than or equal), '<>' (or #) (Not equal) operators with real operands, as these operations can result in precision problems.

Boolean Operators

AND (or &)	Logical and	precedence 6
OR (or)	Logical inclusive or	precedence 7
EXOR (or @)	Logical exclusive or	precedence 8

Note

Boolean operators work with integer numbers. In consequence, 0 means *false*, while any other number means *true*. The value of a logical expression is also integer, i.e., 1 for *true* and 0 for *false*. It is not recommended to use boolean operators with real operands, as these operations can result in precision problems.

FUNCTIONS

Arithmetical Functions

ABS

ABS (x)

Returns the absolute value of x (integer if x integer, real otherwise).

CEIL

CEIL (x)

Returns the smallest integral value that is not smaller than x (always integer). (e.g., CEIL(1.23) = 2; CEIL (-1.9) = -1).

INT

INT (x)

Returns the integral part of x (always integer). (e.g., INT(1.23) = 1, INT(-1.23) = -2).

FRA

FRA (x)

Returns the fractional part of x (integer 0 if x integer, real otherwise). (e.g., FRA(1.23) = 0.23, FRA(-1.23) = 0.77).

ROUND_INT

ROUND_INT (x)

Returns the rounded integer part of x. The 'i = ROUND_INT (x)' expression is equivalent with the following script:

```
IF x < 0.0 THEN i = INT (x - 0.5) ELSE i = INT (x + 0.5)
```

SGN

SGN (x)

Returns +1 integer if x positive, -1 integer if x negative, otherwise 0 integer.

SQR

SQR (x)

Returns the square root of x (always real).

Circular Functions

These functions use degrees for arguments (COS, SIN, TAN) and for return values (ACS, ASN, ATN).

ACS

ACS (x)

Returns the arc cosine of x. ($-1.0 \leq x \leq 1.0$; $0^\circ \leq \text{ACS}(x) \leq 180^\circ$).

ASN

ASN (x)

Returns the arc sine of x. ($-1.0 \leq x \leq 1.0$; $-90^\circ \leq \text{ASN}(x) \leq 90^\circ$).

ATN

ATN (x)

Returns the arc tangent of x. ($-90^\circ \leq \text{ATN}(x) \leq 90^\circ$).

COS

COS (x)

Returns the cosine of x.

SIN

SIN (x)

Returns the sine of x.

TAN

TAN (x)

Returns the tangent of x.

PI

PI

Returns Ludolph's constant. ($p = 3.1415926\dots$).

Note: All return values are real.

Transcendental Functions

EXP

EXP (x)

Returns the xth power of e (e = 2.7182818).

LGT

LGT (x)

Returns the base 10 logarithm of x.

LOG

LOG (x)

Returns the natural logarithm of x.

Note: All returned values are real.

Boolean Functions

NOT

NOT (x)

Returns false (=0 integer) if x is true (<>0), and true (=1 integer) if x is false (=0)(logical negation).

Note: Parameter value should be integer.

Statistical Functions

MIN

MIN (x1, x2, ..., xn)

Returns the smallest of an unlimited number of arguments.

MAX

MAX (x1, x2, ..., xn)

Returns the largest of an unlimited number of arguments.

RND

RND (x)

Returns a random value between 0.0 and x (x > 0.0) always real.

Bit Functions

BITTEST

BITTEST (x, b)

Returns 1 if the b bit of x is set, 0 otherwise.

BITSET

BITSET (x, b [, expr])

expr can be 0 or different, the default value is 1. Sets the b bit of x to 1 or 0 depending on the value of the specified expression, and returns the result. Parameter value should be integer, returned value is integer.

Special Functions

Special functions (besides global variables) can be used in the script to communicate with the executing program. They either ask the current state and different preferences settings of the program, or refer to the current environment of the library part. Request calls can also be used to communicate with GDL extensions.

REQ

REQ (parameter_string)

Asks the current state of the program. Its parameter - the question - is a string. The GDL interpreter answers with a numeric value. If it does not understand the question, the answer is negative.

parameter_string: question string, one of the following:

"GDL_version": version number of the GDL compiler/interpreter. Warning: it is not the same as the ARCHICAD version.

"Program": code of the program (e.g, 1: ARCHICAD),

"Serial_number": the serial number of the keyplug,

"Model_size": size of the current 3D data structure in bytes,

"Red_of_material name"

"Green_of_material name"

"Blue_of_material name": Defines the given material's color components in RGB values between 0 and 1,

"Red_of_pen index"
 "Green_of_pen index"
 "Blue_of_pen index": Defines the given pen's color components in RGB values between 0 and 1,
 "Pen_of_RGB r g b": Defines the index of the pen closest to the given color. The r, g and b constants' values are between 0 and 1.

REQUEST

REQUEST (question_name, name | index, variable1 [, variable2, ...])

The first parameter represents the question string while the second represents the object of the question (if it exists) and can be of either string or numeric type (for example, the question can be "Rgb_of_material" and its object the material's name, or "Rgb_of_pen" and its object the index of the pen). The other parameters are variable names in which the return values (the answers) are stored.

The return value of the requests is always the number of successfully retrieved values (integer), while the type of the retrieved values is defined by each request in part. In the case of a badly formulated question or a nonexistent name, the return value will be 0.

ARCHICAD identifies the order and number of the input parameters by either the version of the command, or the exact name (as string constant) of the request option. Current accepted variations:

- n = REQUEST - default request, with 1 input parameter of string or numeric type
- n = REQUEST{2} - 2 input parameters: string or numeric, string type
- n = REQUEST{3} - 2 input parameters: string, string or numeric array type
- n = REQUEST{4} - 3 input parameters: string or numeric, numeric, string type. *Compatibility: introduced in ARCHICAD 21.*

For the list of available options see the section called "REQUEST Options".

IND

IND (MATERIAL, name_string)
IND (BUILDING_MATERIAL, name_string)
IND (FILL, name_string)
IND (LINE_TYPE, name_string)
IND (STYLE, name_string)
IND (TEXTURE, name_string)
IND (PROFILE_ATTR, name_string, index)

This function returns the current index of the material, building material, fill, line type or style, texture or profile attribute. The main use of the resulting number is to transfer it to a macro that requires the same attribute as the calling macro.

The functions return an attribute index (integer) value. The result is negative for inline definitions (inside the script or from Master_GDL file) and positive for global definitions (from the project attributes).

See also the section called "Inline Attribute Definition".

APPLICATION_QUERY

APPLICATION_QUERY (*extension_name*, *parameter_string*, *variable1*, *variable2*, ...)

GDL allows a way for the individual applications to provide specific request functions in their context. These query options aren't defined in the GDL syntax; consult the GDL developer documentation of the given application for specific options. *See also the section called "Application Query Options"*.

LIBRARYGLOBAL

LIBRARYGLOBAL (*object_name*, *parameter*, *value*)

Fills *value* with the current model view option *parameter* value of the library global object defined by *object_name* if available. A library global setting is available if the global object is currently loaded in the library, or was loaded earlier and its setting was saved in the current model view option combination.

Returns 1 if successful, 0 otherwise.

object_name: name of library global object. Must be a string constant. Warning: If string variables or parameters are used as object names, then the 2d and 3d view of objects querying this library global object will not refresh automatically.

parameter: name of requested parameter.

value: filled with the requested parameter value.

Example:

```
success = LIBRARYGLOBAL ("MyGlobalOptions", "detLevel2D", det)
if success > 0 then
    text2 0, 0, det
else
    text2 0, 0, "Not available"
endif
```

String Functions

STR

STR (*numeric_expression*, *length*, *fractions*)

STR (*format_string*, *numeric_expression*)

The first form of the function creates a string from the current value of the numeric expression. The minimum number for numerical characters in the string is *length*, while *fractions* represents the numbers following the floating point. If the converted value has more than *length* characters, it is expanded as required. If it has fewer characters, it is padded on the left (*length* > 0) or on the right (*length* < 0).

In the second form, the `format_string` can either be a variable or a constant. If the format is empty, it is interpreted as meters, with an accuracy of three decimals (displaying 0s).

Restriction of parameters:

```
length >= -100, length <= 100
fractions <= 20, fractions < length
```

Example:

```
a=4.5
b=2.345
TEXT2 0, 2, STR(a, 8, 2)    ! 4.50
TEXT2 0, 1, STR(b, 8, 2)    ! 2.34
TEXT2 0, 0, STR(a*b, 8, 2) ! 10.55
```

STR{2}

STR{2} (`format_string`, `numeric_expression` [, `extra_accuracy_string`])

Extension of the second form of STR. If the extra accuracy flags are set in the `format_string`, the STR{2} function will return the corresponding extra accuracy string in the 3rd parameter.

format_string: "%[0 or more flags][field_width][.precision] conv_spec"

flags: (for m, mm, cm, dm, e, df, di, sqm, sqcm, sqf, sqi, dd, gr, rad, cum, l, cucm, cumm, cuf, cui, cuy, gal):

- (none) : right justify (default),
- : left justify,
- +: explicit plus sign,
- (space) : in place of a + sign,
- '*0' : extra accuracy Off (default),
- '*1' : extra accuracy .5,
- '*2' : extra accuracy .25,
- '*3' : extra accuracy .1,
- '*4' : extra accuracy .01,
- '*5' : rounding to .5 within displayed decimal range, no returned extra accuracy string, (used for area calculations),
- '*6' : rounding to .25 within displayed decimal range, no returned extra accuracy string, (used for area calculations),
- '*7' : fills the fractional part of `numeric_expression` into the `extra_accuracy_string` in case of `fi` or `ffi`, while the returned expression of the function does not contain the fractional parts,
- '#' : don't display 0s (for m, mm, cm, dm, ffi, fdi, fi, df, di, sqm, sqcm, sqf, sqi, dd, fr, rad, cum, l, cucm, cumm, cuf, cui, cuy, gal),
- '0' : display 0 inches (for ffi, fdi, fi),

'~': hide 0 decimals (effective only if the '#' flag is not specified) (for m, mm, cm, dm, fdi, df, di, sqm, sqcm, sqf, sqi, dd, fr, rad, cum, l, cucm, cumm, cuf, cui, cuy, gal),

'^': do not change decimal separator and digit grouping characters (if not specified, these characters will be replaced as set in the current system).

' [1*j1+2*j2+4*j3] ': display 0 feet and 0 inches before fractions, effective if the '0' flag is not specified (for ffi, fdi, fi)

j1: display 0 inches before fractions (1'-0 3/4")

j2: display 0 inches (1'-0")

j3: display 0 feet before fractions (0 3/4")

field_width: unsigned decimal integer, the minimum number of characters to generate.

precision: unsigned decimal integer, the number of fraction digits to generate.

conv_spec: (conversion specifier):

e: exponential format (meter),

m: meters,

mm: millimeters,

cm: centimeters,

dm: decimeters,

Compatibility: decimeters introduced in ARCHICAD 22.

ffi: feet & fractional inches,

fdi: feet & decimal inches,

df: decimal feet,

fi: fractional inches,

di: decimal inches,

pt: points,

for areas:

sqm: square meters,

sqcm: square centimeters,

sqmm: square millimeters,

sqf: square feet,

sqi: square inches,

for angles:

dd: decimal degrees,

dms: degrees, minutes, seconds,
 gr: grads,
 rad: radians,
 surv: surveyors unit,
 for volumes:
 cum: cubic meters,
 l: liters,
 cucm: cubic centimeters,
 cumm: cubic millimeters,
 cuf: cubic feet,
 cui: cubic inches,
 cuy: cubic yards,
 gal: gallons.

Example:

```

nr = 0.345678
TEXT2 0, 23, STR ("%m", nr)      !0.346
TEXT2 0, 22, STR ("%#10.2m", nr) !35
TEXT2 0, 21, STR ("% .4cm", nr)  !34.5678
TEXT2 0, 20, STR ("%12.4cm", nr) ! 34.5678
TEXT2 0, 19, STR ("% .6mm", nr)  !345.678000
TEXT2 0, 18, STR ("% +15e", nr)  !+3.456780e-01
TEXT2 0, 17, STR ("% ffi", nr)   !1'-2"
TEXT2 0, 16, STR ("%0.16 ffi", nr) !1'-1 5/8"
TEXT2 0, 15, STR ("% .3fdi", nr) ! 1'-1.609"
TEXT2 0, 14, STR ("% -10.4df", nr) ! 1.1341'
TEXT2 0, 13, STR ("%0.64fi", nr) !13 39/64"
TEXT2 0, 12, STR ("% +12.4di", nr) !+13.6094"
TEXT2 0, 11, STR ("%# .3sqm", nr) !346
TEXT2 0, 10, STR ("% +sqcm", nr) !+3,456.78
TEXT2 0, 9, STR ("% .2sqmm", nr) ! 345,678.00
TEXT2 0, 8, STR ("% -12sqf", nr) !3.72
TEXT2 0, 7, STR ("%10sqi", nr)  ! 535.80
TEXT2 0, 6, STR ("% .2pt", nr)   !0.35
  
```

```

alpha = 88.657
TEXT2 0, 5, STR ("%10.3dd", alpha) !+88.657°
TEXT2 0, 4, STR ("%1dms", alpha) !88°39'
TEXT2 0, 3, STR ("%2dms", alpha) !88°39'25"
TEXT2 0, 2, STR ("%10.4gr", alpha) ! 98.5078G
TEXT2 0, 1, STR ("%rad", alpha) !1.55R
TEXT2 0, 0, STR ("%2surv", alpha) !N 1°20'35" E

nr = 1'-0 3/4"
TEXT2 0, -1, STR ("%1].16ffi", nr) !1'-0 3/4"
nr = 1'-0"
TEXT2 0, -2, STR ("%5].16ffi", nr) !1'
nr = 0 3/4"
TEXT2 0, -3, STR ("%#[7].16ffi", nr) !0 3/4"

nr = 0.34278
TEXT2 0, 0, STR ("%*5 .4m", nr) !0.3430

! split to integral and fractional parts
extra_accuracy_string = ""
nr = 1'-0 3/4"

TEXT2 0, -3, STR{2} ("%*7.16ffi", nr, extra_accuracy_string) !1'-
TEXT2 0, -4, extra_accuracy_string !3/4"

```

SPLIT

SPLIT (string, format, variable1 [, variable2, ..., variablen])

Splits the string parameter according to the format in one or more numeric or string parts. The split process stops when the first non-matching part is encountered. Returns the number of successfully read values (integer).

string: the string to be split.

format: any combination of constant strings, %, %n and %ⁿ -s. Parts in the string must fit the constant strings, %s denotes any string value delimited by spaces or tabs, while %n or %ⁿ denotes any numeric value. If the '^' flag is present, current system settings for decimal separator and digit grouping characters are taken into consideration when matching the actual numerical value.

variablei: names of the variables to store the split string parts.

Example:

```
ss = "3 pieces 2x5 beam"
n = SPLIT (ss, "%n pieces %nx%n %s", num, ss1, size1, ss2, size2, name)
IF n = 6 THEN
    PRINT num, ss1, size1, ss2, size2, name ! 3 pieces 2 x 5 beam
ELSE
    PRINT "ERROR"
ENDIF
```

STW

STW (string_expression)

Returns the (real) width of the string in millimeters displayed in the current style. The width in meters, at current scale, is $STW(\text{string_expression}) / 1000 * GLOB_SCALE$.

Example:



```
DEFINE STYLE "own" "Gabriola", 180000 / GLOB_SCALE, 1, 0
SET STYLE "own"
string = "abcd"
width = STW (string) / 1000 * GLOB_SCALE
n = REQUEST ("Height_of_style", "own", height)
height = height / 1000 * GLOB_SCALE
TEXT2 0,0, string
RECT2 0,0, width, -height
```

STRLEN

STRLEN (string_expression)

Returns the (integer) length of the string (the number of characters)

STRSTR

STRSTR (string_expression1, string_expression2[, case_insensitivity])

Returns the (integer) position of the first appearance of the second string in the first string. If the first string doesn't contain the second one, the function returns 0.

Note: In case string_expression2 is an empty string, the function returns 1.

case_insensitivity:

0 or not set: Case sensitive

1: Case insensitive

Example 1:

```
szFormat = ""
n = REQUEST ("Linear_dimension", "", szFormat)
unit = ""
IF STRSTR (szFormat, "m") > 0 THEN unit = "m"
IF STRSTR (szFormat, "mm") > 0 THEN unit = "mm"
IF STRSTR (szFormat, "cm") > 0 THEN unit = "cm"
IF STRSTR (szFormat, "dm") > 0 THEN unit = "dm"
TEXT2 0, 0, STR (szFormat, a) + " " + unit !1.00 m
```

Example 2:

```
STRSTR ("abcdefg", "BCdEf") = 0
STRSTR ("abcdefg", "BCdEf", 0) = 0
STRSTR ("abcdefg", "BCdEf", 1) = 2
```

STRSUB

STRSUB (string_expression, start_position, characters_number)

Returns a substring of the string parameter that begins at the position given by the start_position parameter and its length is characters_number characters.

Example:

```
string = "Flowers.jpeg"
len = STRLEN (string)
iDotPos = STRSTR (string, ".")
TEXT2 0, -1, STRSUB (string, 1, iDotPos - 1) !Flowers
TEXT2 0, -2, STRSUB (string, len - 4, 5) !.jpeg
```

STRTOUPPER

STRTOUPPER (string_expression)

Returns a string converted to uppercase.

Example:

```
_oldString = "flower"  
_newString = STRTOUPPER (_oldString)    ! _newString will be "FLOWER"
```

STRTOLOWER

STRTOLOWER (string_expression)

Returns a string converted to lowercase.

Example:

```
_oldString = "FLOWER"  
_newString = STRTOLOWER (_oldString)    ! _newString will be "flower"
```

CONTROL STATEMENTS

This chapter reviews the GDL commands available for controlling loops and subroutines in scripts and introduces the concept of buffer manipulation designed to store parameter values for further use. It also explains how to use objects as macro calls and how to display calculated expressions on screen.

FLOW CONTROL STATEMENTS

FOR - TO - NEXT

FOR variable_name = initial_value **TO** end_value [**STEP** step_value] **NEXT** variable_name

FOR is the first statement of a FOR loop.

NEXT is the last statement of a FOR loop.

The loop variable varies from the initial_value to the end_value by the step_value increment (or decrement) in each execution of the body of the loop (statements between the FOR and NEXT statements). If the loop variable exceeds the value of the end_value, the program executes the statement following the NEXT statement.

If the STEP keyword and the step_value are missing, the step is assumed to be 1.

Note: Changing the step_value during the execution of the loop has no effect.

A global variable is not allowed as a loop control variable.

Example 1:

```
FOR i=1 TO 10 STEP 2
    PRINT i
NEXT i
```

Example 2:

! The two program fragments below are equivalent:

```
! 1st
a = b
1:
IF c > 0 AND a > d OR c < 0 AND a < d THEN 2
PRINT a
a = a + c
GOTO 1
```

```
! 2nd
2:
FOR a = b TO d STEP c
    PRINT a
NEXT a
```

The above example shows that `step_value = 0` causes an infinite loop.

Only one `NEXT` statement is allowed after a `FOR` statement. You can exit the loop with the `GOTO` command and to return after leaving, but you cannot enter a loop skipping the `FOR` statement.

DO - WHILE

```
DO [statement1
    statement2
    ...
    statementn]
WHILE condition
```

The statements between the keywords are executed as long as the condition is true.

The condition is checked after each execution of the statements.

WHILE - ENDWHILE

```
WHILE condition DO
    [statement1
    statement2
    ...
    statementn]
ENDWHILE
```

The statements between the keywords are executed as long as the condition is true.

The condition is checked before each execution of the statements.

REPEAT - UNTIL

```
REPEAT [statement1  
        statement2  
        ...  
        statementn]  
UNTIL condition
```

The statements between the keywords are executed until the condition becomes true.

The condition is checked after each execution of the statements.

Example: The following four sequences of GDL commands are equivalent

```
! 1st
FOR i = 1 TO 5 STEP 1
    BRICK 0.5, 0.5, 0.1
    ADDZ 0.3
NEXT i
```

```
! 2nd
i = 1
DO
    BRICK 0.5, 0.5, 0.1
    ADDZ 0.3
    i = i + 1
WHILE i <= 5
```

```
! 3rd
i = 1
WHILE i <= 5 DO
    BRICK 0.5, 0.5, 0.1
    ADDZ 0.3
    i = i + 1
ENDWHILE
```

```
! 4th
i = 1
REPEAT
    BRICK 0.5, 0.5, 0.1
    ADDZ 0.3
    i = i + 1
UNTIL i > 5
```

IF - GOTO

```
IF condition THEN label
IF condition GOTO label
IF condition GOSUB label
```

Conditional jump statement. If the value of the condition expression is 0 (logical 'false'), the command has no effect, otherwise execution continues at the label. THEN, GOTO or THEN GOTO are equivalent in this context.

Example:

```
IF a THEN 28
IF i > j GOTO 200+i*j
IF i > 0 GOSUB 9000
```

IF - THEN - ELSE - ENDIF

```
IF condition THEN statement [ELSE statement]
IF condition THEN
    [statement1
    statement2
    ...
    statementn]
[ELSE
    statementn+1
    statementn+2
    ...
    statementn+m]
ENDIF
```

If you write only one command after keywords THEN and/or ELSE in the same row, there is no need for ENDIF. A command after THEN or ELSE in the same row means a definite ENDIF.

If there is a new row after THEN, the successive commands (all of them until the keyword ELSE or ENDIF) will only be executed if the expression in the condition is true (other than zero). Otherwise, the commands following ELSE will be carried out. If the ELSE keyword is absent, the commands after ENDIF will be carried out.

Example:

```
IF a = b THEN height = 5 ELSE height = 7
IF needDoors THEN
    CALL "door_macro" PARAMETERS
    ADDX a
ENDIF
IF simple THEN
    HOTSPOT2 0, 0
    RECT2 a, 0, 0, b
ELSE PROJECT2 3, 270, 1
IF name = "Sphere" THEN
    ADDY b
    SPHERE 1
ELSE
    ROTX 90
    TEXT 0.002, 0, name
ENDIF
```

GOTO

GOTO label

Unconditional jump statement. The program executes a branch to the statement denoted by the value of the label (numerical or string). Variable label expressions can slow down interpretation due to runtime jumping address determination.

Example:

```
GOTO K+2
```

GOSUB

GOSUB label

Internal subroutine call where the label is the entry point of the subroutine. Label value can be any numerical or string expression. Variable label expressions can slow down interpretation due to runtime jumping address determination.

RETURN

RETURN

Return from an internal subroutine.

END / EXIT

```
END [v1, v2, ..., vn]
EXIT [v1, v2, ..., vn]
```

End of the current GDL script. The program terminates or returns to the level above. It is possible to use several ENDS or EXITS in a GDL file. If the optional list of values is specified, the current script will pass these return values to its caller.

*Note: the number of possible returned elements is limited at 32767 items.
See the description of receiving returned parameters at the CALL command.*

BREAKPOINT

```
BREAKPOINT expression
```

With this command, you can specify a breakpoint in the GDL script. The GDL debugger will stop at this command if the value of the parameter (a numeric expression) is true (1) and the Enable Breakpoints option of the debugger is checked. In normal execution mode, the GDL interpreter simply steps over this command.

PARAMETER BUFFER MANIPULATION

The parameter buffer is a built-in data structure that may be used if some values (coordinates, for example) change after a definite rule that can be described using a mathematical expression. This is useful if, for instance, you want to store the current values of your variables.

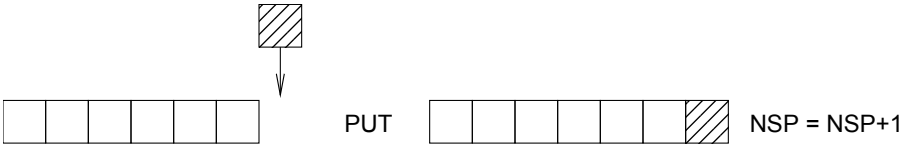

The parameter buffer is an infinitely long array in which you can store numeric values using the PUT command. PUT stores the given values at the end of the buffer. These values can later be used (by the GET and USE commands) in the order in which they were entered (i.e., the first stored value will be the first one used). A GET(n) or USE(n) command is equivalent with n values separated by commas. This way, they can be used in any GDL parameter list where n values are needed.

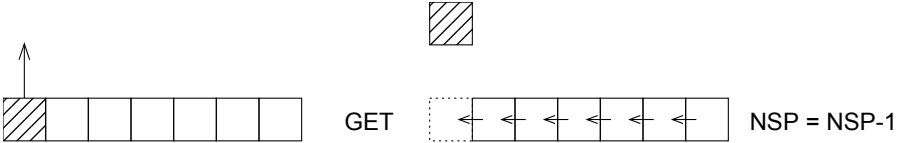

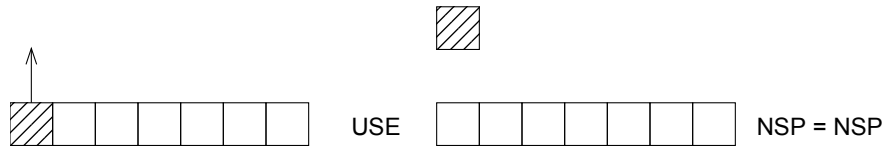
**PUT****PUT** expression [, expression, ...]

Store the given values in the given order in the internal parameter buffer.

GET**GET** (n)

Use the next n values from the internal parameter buffer and then disregard them.

USE**USE** (n)

Use the next n values from the internal parameter buffer without deleting them. Following USE and GET functions can use the same parameter sequence.

NSP**NSP**

Returns the number of stored parameters in the internal buffer.

Example: Using the parameter buffer:

```

r=2: b=6: c=4: d=10
n=12

s=180/n
FOR t=0 TO 180 STEP s
  PUT r+r*COS(T), c-r*SIN(t), 1
NEXT t
FOR i=1 TO 2
  EXTRUDE 3+NSP/3, 0,0,d, 1+16,
          0, b, 0,
          2*r, b, 0,
          USE(NSP),
          0, b, 0
  MULY -1
NEXT i
DEL 1
ADDZ d
REVOLVE 3+NSP/3, 180, 0,
        0, b, 0,
        2*r, b, 0,
        GET(NSP),
        0, b, 0

```

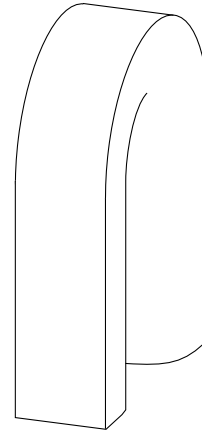

The full description:

```
r=2: b=6: c=4: d=10
FOR i=1 TO 2
  EXTRUDE 16, 0,0,d, 1+16,
    0, b, 0,
    2*r, b, 0,
    2*r, c, 1,
    r+r*COS(15), c-r*SIN(15), 1,
    r+r*COS(30), c-r*SIN(30), 1,
    r+r*COS(45), c-r*SIN(45), 1,
    r+r*COS(60), c-r*SIN(50), 1,
    r+r*COS(75), c-r*SIN(75), 1,
    r+r*COS(90), c-r*SIN(90), 1,
    r+r*COS(105), c-r*SIN(105), 1,
    r+r*COS(120), c-r*SIN(120), 1,
    r+r*COS(135), c-r*SIN(135), 1,
    r+r*COS(150), c-r*SIN(150), 1,
    R+R*COS(165), c-r*SIN(165), 1,
    0, b, 1,
    0, b, 0
  MPLY -1
NEXT i
DEL 1
```

```

ADDZ d
REVOLVE 16, 180, 0,
        0, b, 0,
        2*r, b, 0,
        2*r, c, 1,
        r+r*COS(15), c-r*SIN(15), 1,
        r+r*COS(30), c-r*SIN(30), 1,
        r+r*COS(45), c-r*SIN(45), 1,
        r+r*COS(60), c-r*SIN(50), 1,
        r+r*COS(75), c-r*SIN(75), 1,
        r+r*COS(90), c-r*SIN(90), 1,
        r+r*COS(105), c-r*SIN(105), 1,
        r+r*COS(120), c-r*SIN(120), 1,
        r+r*COS(135), c-r*SIN(135), 1,
        r+r*COS(150), c-r*SIN(150), 1,
        r+r*COS(165), c-r*SIN(165), 1,
        0, b, 1,
        0, b, 0

```

MACRO OBJECTS

Although the 3D objects you may need can always be broken down into complex or primitive elements, sometimes it is desirable to define these complex elements specifically for certain applications. These individually defined elements are called macros. A GDL macro has its own environment which depends on its calling order. The current values of the `MODEL`, `RADIUS`, `RESOL`, `TOLER`, `PEN`, `LINE_TYPE`, `MATERIAL`, `FILL`, `STYLE`, `SHADOW` options and the current transformation are all valid in the macro. You can use or modify them, but the modifications will only have an effect locally. They do not take effect on the level the macro was called from. Giving parameters to a macro call means an implicit value assignment on the macro's level. The parameters A and B are generally used for resizing objects.

CALL

```

CALL macro_name_string [,]
      PARAMETERS [ALL] [name1=value1, ..., namen=valuen] [[,]
      RETURNED_PARAMETERS r1, r2, ...]

```

macro_name_string: string, the name of an existing library part

Macro names cannot be longer than 31 characters. Macro names can be string constants, string variables or parameters. String operations cannot be used with a macro call as a macro name. Warning: If string variables or parameters are used as macro names, the called macro may not be included in the archive project. To let GDL know about the dependency, use the `FILE_DEPENDENCE` command for each

This form of macro call can be used for compatibility with previous versions. Can be used with simple GDL text files as well as any library part, on the condition that its parameter list contains only single-letter numerical parameters (A ... Z). No string type expressions or arrays are allowed with this method. The parameter list is a list of simple numerical values: the value of parameter A will be the first value in the list, the value of parameter B will be the second value, and so on. If there are less than A ... Z values specified in the parameter list, for the missing values 0 will be used automatically. If the (library part) macro does not have a single-letter parameter corresponding to the value, interpretation will continue by skipping this value, but you will get a warning from the program.

Example:

```
CALL "leg" 2, , 5 ! A = 2, B = 0, C = 5 leg 2, , 5
CALL "door-1" PARAMETERS height = 2, a = 25.5,
    name = "Director"
CALL "door-1" PARAMETERS      ! use parameter default values
```

OUTPUT IN AN ALERT BOX OR REPORT WINDOW

PRINT

PRINT expression [, expression, ...]

Writes all of its arguments in a dialog box or the Report Window, depending on Work Environment (see the section called “GDL warnings”). Arguments can be strings or numeric expressions of any number in any sequence, separated by commas.

Example:

```
PRINT "loop-variable:", i
PRINT j, k-3*1
PRINT "Beginning of interpretation"
PRINT a * SIN (alpha) + b * COS (alpha)
PRINT "Parameter values: ", "a = ", a, ", b = ", b
PRINT name + STR ("%m", i) + "." + ext
```

FILE OPERATIONS

The following keywords allow you to open external files for reading/writing and to manipulate them by putting/getting values from/to GDL scripts. This process necessarily involves using special Add-On extensions. Text files can be handled by the section called “GDL Text I/O Add-On”. Add-Ons for other file types can be developed by third parties.

See also the section called “GDL Text I/O Add-On”.

OPEN

OPEN (*filter*, *filename*, *parameter_string*)

Opens a file as directed. Its return value is a positive integer that will identify the specific file, -2 if the add-on is missing, -1 if the file is missing. If positive, this value, the channel number, will be the file's reference number in succeeding instances. To include the referenced file in the archive project, use the FILE_DEPENDENCE command with the file name.

filter: string, the name of an existing extension.

filename: string, the name of the file.

parameter_string: string, it contains the specific separation characters of the operational extension and the mode of opening. Its contents are interpreted by the extension.

INPUT

INPUT (*channel*, *recordID*, *fieldID*, *variable1* [, *variable2*, ...])

The number of given parameters defines the number of values from the starting position read from the file identified by the channel value. The parameter list must contain at least one value. This function puts the read values into the parameters as ordered. These values can be of numeric or string type, independent of the parameter type defined for storage.

The return value is the number of the successfully read values. When encountering an end of file character, -1 is returned.

recordID, **fieldID:** the string or numeric type starting position of the reading, its contents are interpreted by the extension.

VARTYPE

VARTYPE (*expression*)

Returns the type of the expression:

- 1 - numerical
- 2 - string
- 3 - group (as result of the ADDGROUP command and such)
- 4 - dictionary

Useful when reading values in variables with the INPUT command, which can change between type 1 and 2 according to the current values. The type of these variables is not checked during the compilation process.

OUTPUT

OUTPUT *channel*, *recordID*, *fieldID*, *expression1* [, *expression2*, ...]

Writes as many values into the file identified by the channel value from the given position as there are defined expressions. There has to be at least one expression. The type of values is the same as those of the expressions.

recordID, **fieldID**: the string or numeric type starting position of the writing; its contents are interpreted by the extension.

CLOSE

CLOSE channel

Closes the file identified by the channel value.

USING DETERMINISTIC ADD-ONS

The following keywords allow you to call GDL add-ons which provide a deterministic function, i.e. the result of a given operation depends on the specified parameters only. This process necessarily involves using special Add-On extensions. For example polygon operations can be executed via the PolyOperations add-on. Add-Ons for other operations can be developed by third parties.

See also the section called "Polygon Operations Extension".

INITADDDONSCOPE

INITADDDONSCOPE (extension, parameter_string1, parameter_string2)

Opens a channel as directed. Its return value is a positive integer that will identify the specific connection. This value, the channel number, will be the connection's reference number in succeeding instances.

extension: string, the name of an existing extension.

parameter_string1: string, its contents are interpreted by the extension.

parameter_string2: string, its contents are interpreted by the extension.

PREPAREFUNCTION

PREPAREFUNCTION channel, function_name, expression1 [, expression2, ...]

Sets some values in the add-on as a preparation step for calling a later function.

function_name: the string or numeric identifier of the function to be called; its contents are interpreted by the extension.

expression: parameters to be passed for the preparation step.

CALLFUNCTION

CALLFUNCTION (channel, function_name, parameter, variable1 [, variable2, ...])

The function named *function_name* in the add-on specified by *channel* is called. The parameter list must contain at least one value. This function puts the returned values into the parameters as ordered. The return value is the number of the successfully set values.

channel: channel value, used to identify the connection.

function_name: the string or numeric identifier of the function to be called; its contents are interpreted by the extension.

parameter: input parameter; its contents are interpreted by the extension.

variablei: output parameter.

CLOSEADDONSCOPE

CLOSEADDONSCOPE channel

Closes the connection identified by the channel value.

MISCELLANEOUS

GDL can also handle a number of operations on external files through special Add-On applications. The commands used to achieve this are described in this chapter and illustrated with an example.

GLOBAL VARIABLES

The global variables make it possible to store special values of the model. This allows you to access geometric information about the environment of the GDL macro. For example, you can access the wall parameters when defining a window which has to fit into the wall. Global variables are not stacked during macro calls.

For doors, windows, labels and property library parts there is one more possibility to communicate with ARCHICAD through fix named, optional parameters. These parameters, if present on the library part's parameter list, are set by ARCHICAD. *See the list of fix named parameters and more details in the section called "Fix named optional parameters".*

Script compatibility

View or project dependent global variables should not be used in parameter scripts (or master scripts run as parameter script) to avoid the parameter script run occasions and the resulting parameter values becoming context dependent, inconsistent within the planfile.



Compatibility up to ARCHICAD 19: Such globals accidentally used in parameter script generate GDL warnings.

Compatibility starting from ARCHICAD 20: Such globals used in parameter script generate GDL warnings, and will contain a static default value only (type-matching).

Compatibility starting from ARCHICAD 22: View dependent global variables should not be used in property scripts (or master scripts run as property script). Such instances will cause warnings in scripts. However, project dependant variables are enabled in property script most cases.

For compatibility details, check out the global variable descriptions. Script type restrictions apply where indicated.

Legend





	works without restriction
	works (with additional warning)
	contains dummy default value (with additional warning)

General environment information

GLOB_SCRIPT_TYPE type of current script

- 1 - *properties script*
- 2 - *2D script*
- 3 - *3D script*
- 4 - *user interface script*
- 5 - *parameter script*
- 6 - *master script*
- 7 - *forward migration script*
- 8 - *backward migration script*

GLOB_VIEW_TYPE type of current view (view dependent, do not use in parameter/property scripts).

2D		3D		UI		Parameter		Property		Default	-
----	---	----	---	----	---	-----------	---	----------	---	---------	---

- 2 - *2D (Floor Plan)*
- 3 - *3D*
- 4 - *Section*
- 5 - *Elevation*
- 6 - *3D Document*
- 7 - *Detail*
- 8 - *Layout*
- 9 - *Calculation*

Use the exact needed values. Using ranges are not recommended due to possible future value extensions.

GLOB_PREVIEW_MODE type of current preview (view dependent, do not use in parameter/property scripts)

- 0 - *None*
- 1 - *Dialog*
- 2 - *Listing*
- 3 - *Favorite saving*

Use the exact needed values. Using ranges are not recommended due to possible future value extensions.

GLOB_FEEDBACK_MODE indicates editing in progress (view dependent, do not use in parameter/property scripts)

0 - off, 1 - editing feedback mode

GLOB_SEO_TOOL_MODE indicates solid element operations in progress (view dependent, do not use in parameter/property scripts)

0 - off, 1 - solid element operations mode

GLOB_DIAGNOSTICS_MODE Library Developer (59) menu command for GDL diagnostics

Compatibility: introduced in ARCHICAD 23.

0 - off, 1 - on

Use in scripts as a conditional statement to visualize debug content of library parts.

GLOB_SCALE drawing scale (view dependent, do not use in parameter/property scripts)

2D	✓	3D	✓	UI	✗	Parameter	✗	Property	✗	Default	100
----	---	----	---	----	---	-----------	---	----------	---	---------	-----

according to the current window

GLOB_DRAWING_BGD_PEN pen of the drawing background color (view dependent, do not use in parameter/property scripts)

2D	✓	3D	✓	UI	✗	Parameter	✗	Property	✗	Default	19
----	---	----	---	----	---	-----------	---	----------	---	---------	----

the best matching (printable) pen from the current palette to the background color of the current window

GLOB_FILL_INDEX_SOLID index of fill type "Solid" according to the template (project dependent, do not use in parameter script)

2D	✓	3D	✓	UI	✓	Parameter	✗	Property	✗	Default	16
----	---	----	---	----	---	-----------	---	----------	---	---------	----

contains the applied index of the fill type "Solid"

Compatibility: introduced in ARCHICAD 22.

GLOB_FILL_INDEX_BACKGROUND index of fill type "Background" according to the template (project dependent, do not use in parameter script)

2D	✓	3D	✓	UI	✓	Parameter	✗	Property	✗	Default	16
----	---	----	---	----	---	-----------	---	----------	---	---------	----

contains the applied index of the fill type "Background"

Compatibility: introduced in ARCHICAD 22.

GLOB_NORTH_DIR project North direction (project dependent, do not use in parameter script)

2D	✓	3D	✓	UI	✗	Parameter	✗	Property	✓	Default	90
----	---	----	---	----	---	-----------	---	----------	---	---------	----

relative to the default project coordinate system according to the settings made in the Project Location dialog

GLOB_PROJECT_LONGITUDE project longitude (project dependent, do not use in parameter script)

GLOB_PROJECT_LATITUDE project latitude (project dependent, do not use in parameter script)

GLOB_PROJECT_ALTITUDE project altitude (project dependent, do not use in parameter script)

2D	✓	3D	✓	UI	✗	Parameter	✗	Property	✓	Default	0
----	---	----	---	----	---	-----------	---	----------	---	---------	---

the geographical coordinates of the project origin according to the settings specified in the Project Location dialog

GLOB_PROJECT_DATE project date (project dependent, do not use in parameter script)

2D	✓	3D	✓	UI	✗	Parameter	✗	Property	✓	Default	[0, 0, 0, 0, 0, 0]
----	---	----	---	----	---	-----------	---	----------	---	---------	--------------------

array of the following six values: 1 - year, 2 - month, 3 - day, 4 - hour, 5 - minute, 6 - second. This variable contains the project's current date and is only set in the EcoDesigner STAR[®] add-on (in other cases all values are set to 0). The value of this variable is modified by the add-on when running the solar analysis routines to allow certain GDL objects (for example deciduous trees) to be represented differently at different times of the year.

GLOB_WORLD_ORIGO_OFFSET_X (project dependent, do not use in parameter script)

GLOB_WORLD_ORIGO_OFFSET_Y (project dependent, do not use in parameter script)

2D	✓	3D	✓	UI	✗	Parameter	✗	Property	✓	Default	0
----	---	----	---	----	---	-----------	---	----------	---	---------	---

*Position of the project origin relative to the world origin. See *Illustrating the usage of the GLOB_WORLD_ORIGO_... globals.**

GLOB_MODPAR_NAME name of the last modified parameter

in the settings dialog or library part editor, including parameters modified through editable hotspots.

GLOB_UI_BUTTON_ID id of the button pushed on the UI page

or 0, if the last action was not the push of a button with id.

GLOB_CUTPLANES_INFO (project dependent, do not use in parameter script)

2D	✓	3D	✓	UI	✗	Parameter	✗	Property	✓	Default	[1., 3.0, -0.1, -0.1]
----	---	----	---	----	---	-----------	---	----------	---	---------	-----------------------

array of 4 length values: 1 - cutplane height, 2 - cutplane top level, 3 - cutplane bottom level, 4 - absolute display limit, in the library part's local coordinate system. See details in ARCHICAD Set Floor Plan Cutplane dialog.

GLOB_STRUCTURE_DISPLAY

structure display detail (project dependent, do not use in parameter script)

2D	✔	3D	✔	UI	✘	Parameter	✘	Property	✔	Default	0
----	---	----	---	----	---	-----------	---	----------	---	---------	---

informs about the partial structure display option settings (integer): 0 - entire structure, 1 - core only, 2 - without finishes

GLOB_ISSUE_SCHEME

list of custom data defined in the Issue Scheme

2D	✔	3D	✔	UI	✔	Parameter	✔	Property	✘	Default	-
----	---	----	---	----	---	-----------	---	----------	---	---------	---

Available in all context. 2-row string array, containing the names of fields defined in the Issue Scheme (first row), with the corresponding GUIDs (second row). The first five columns are fixed: Revision ID, Issue ID, Issue Name, Issue Date, Issued by.

For example:

<i>Revision ID</i>	<i>Issue ID</i>	<i>Issue Name</i>	<i>Issue Date</i>	<i>Issued By</i>	<i>Recipient</i>	<i>Status</i>	<i>...</i>
{RevIdGUID}	{IssueIdGUID}	{IssueNameGUID}	{IssueDateGUID}	{IssuedByGUID}	{Custom1GUID}	{Custom2GUID}	

LAYOUT_REVISION_HISTORY

list of the current Layout's Revision History

2D	✔	3D	✔	UI	✔	Parameter	✔	Property	✘	Default	-
----	---	----	---	----	---	-----------	---	----------	---	---------	---

Available in Layout context only. String array, containing 1 row per Revision, in the same structure as GLOB_ISSUE_SCHEME. The first five columns are fixed: Revision ID, Issue ID, Issue Name, Issue Date, Issued by.

For example:

01	1	First Issue	2013-06-30	user1	Everyone	SD	...
02	3	General Update	2013-07-31	user2	Mechanical	DD	
03	5	Structural Update	2013-08-31	user1	Structural	DD	
...							

GLOB_CHANGE_SCHEME

list of custom data defined in the Change Scheme

2D	✔	3D	✔	UI	✔	Parameter	✔	Property	✘	Default	-
----	---	----	---	----	---	-----------	---	----------	---	---------	---

Available in all context. 2-row string array, containing the names of fields defined in the Change Scheme (first row), with the corresponding GUIDs (second row). The first five columns are fixed: Revision ID, Change ID, Change Name, Last Modified Date, Last Modified by.

For example:

Revision ID	Change ID	Change Description	Last Modified	Last Modified By	Created by	Approved by	...
{RevIdGUID}	{ChIdGUID}	{ChDescGUID}	{ModiTimeGUID}	{ModiByGUID}	{Custom1GUID}	{Custom2GUID}	

LAYOUT_CHANGE_HISTORY

list of all the Changes appearing in the current Layout's Revision History

2D	✔	3D	✔	UI	✔	Parameter	✔	Property	✘	Default	-
----	---	----	---	----	---	-----------	---	----------	---	---------	---

Available in Layout context only. String array, containing 1 row per Change, in the same structure as GLOB_CHANGE_SCHEME. The first five columns are fixed: Revision ID, Change ID, Change Name, Last Modified Date, Last Modified by.

For example:

2	Ch-13	Kitchen	2013-07-13	user1	Architect 1	Lead Architect 1	...
2	Ch-15	Ventillation	2013-07-16	user2	Architect 2	Lead Architect 1	
3	Ch-18	Structural Col.	2013-08-03	user2	Architect 1	Lead Architect 2	
3	Ch-19	Truss Sections	2013-08-12	user1	Architect 3	Lead Architect 2	
B	Ch-23	Door Numbering	2013-10-01	user3	Architect 2	Lead Architect 1	
...							

LAYOUT_CURRENTREVISION_OPEN

Work in Progress state of the current Layout (project dependent, do not use in parameter script)

2D	✔	3D	✔	UI	✘	Parameter	✘	Property	✔	Default	0
----	---	----	---	----	---	-----------	---	----------	---	---------	---

Available in Layout context only. 0 - current Layout has no open Revision, 1 - current Layout has an open Revision (it is a Work in Progress Layout)

Story information

GLOB_HSTORY_ELEV		elevation of the home story (project dependent, do not use in parameter script)									
2D	✓	3D	✓	UI	✗	Parameter	✗	Property	✓	Default	0

home story is the one the object is placed on

GLOB_HSTORY_HEIGHT		height of the home story (project dependent, do not use in parameter script)									
2D	✓	3D	✓	UI	✗	Parameter	✗	Property	✓	Default	3.1

home story is the one the object is placed on

GLOB_CSTORY_ELEV		elevation of the current story (project dependent, do not use in parameter script)									
2D	✓	3D	✓	UI	✗	Parameter	✗	Property	✓	Default	0.0

current story is the one currently shown in the Floor Plan window

GLOB_CSTORY_HEIGHT		height of the current story (project dependent, do not use in parameter script)									
2D	✓	3D	✓	UI	✗	Parameter	✗	Property	✓	Default	3.1

current story is the one currently shown in the Floor Plan window

GLOB_CH_STORY_DIST		relative position of the current story to the home story (project dependent, do not use in parameter script)									
2D	✓	3D	✓	UI	✗	Parameter	✗	Property	✓	Default	0.0

current story is the one currently shown in the Floor Plan window

Fly-through information

GLOB_FRAME_NR		current frame number in animation (view dependent, do not use in parameter/property scripts)									
2D	✓	3D	✓	UI	✗	Parameter	✗	Property	✗	Default	-1

valid only for animation, -1 for still images

GLOB_FIRST_FRAME		first frame index in fly-through (view dependent, do not use in parameter/property scripts)									
2D	✓	3D	✓	UI	✗	Parameter	✗	Property	✗	Default	0
<i>valid only for animation, 0 for still images</i>											
GLOB_LAST_FRAME		last frame index in fly-through (view dependent, do not use in parameter/property scripts)									
2D	✓	3D	✓	UI	✗	Parameter	✗	Property	✗	Default	0
<i>valid only for animation, 0 for still images</i>											
GLOB_EYEPOS_X		current camera position (x) (view dependent, do not use in parameter/property scripts)									
2D	✓	3D	✓	UI	✗	Parameter	✗	Property	✗	Default	-5.0
<i>valid only in perspective projection for both animation and still images</i>											
GLOB_EYEPOS_Y		current camera position (y) (view dependent, do not use in parameter/property scripts)									
2D	✓	3D	✓	UI	✗	Parameter	✗	Property	✗	Default	-5.0
<i>valid only in perspective projection for both animation and still images</i>											
GLOB_EYEPOS_Z		current camera position (z) (view dependent, do not use in parameter/property scripts)									
2D	✓	3D	✓	UI	✗	Parameter	✗	Property	✗	Default	1.7
<i>valid only in perspective projection for both animation and still images</i>											
GLOB_TARGPOS_X		current target position (x) (view dependent, do not use in parameter/property scripts)									
2D	✓	3D	✓	UI	✗	Parameter	✗	Property	✗	Default	0.0
<i>valid only in perspective projection for both animation and still images</i>											
GLOB_TARGPOS_Y		current target position (y) (view dependent, do not use in parameter/property scripts)									
2D	✓	3D	✓	UI	✗	Parameter	✗	Property	✗	Default	0.0
<i>valid only in perspective projection for both animation and still images</i>											

GLOB_TARGPOS_Z		current target position (z) (view dependent, do not use in parameter/property scripts)									
2D	✓	3D	✓	UI	✗	Parameter	✗	Property	✗	Default	1.7

valid only in perspective projection for both animation and still images

GLOB_SUN_AZIMUTH		sun azimuth (project dependent, do not use in parameter script)									
2D	✓	3D	✓	UI	✗	Parameter	✗	Property	✓	Default	240

according to the settings in the Sun... dialog box

GLOB_SUN_ALTITUDE		sun altitude (project dependent, do not use in parameter script)									
2D	✓	3D	✓	UI	✗	Parameter	✗	Property	✓	Default	35

according to the settings in the Sun... dialog box

General element parameters

GLOB_LAYER		layer of the element									
<i>name of the layer the element is assigned to</i>											

GLOB_ID		user ID of the element									
<i>ID as set in the settings dialog box</i>											

GLOB_INTGUID		internal GUID of the element									
<i>the internal GUID generated by the program (cannot be controlled by the user)</i>											

GLOB_ELEVATION		base elevation of the element									
<ul style="list-style-type: none"> • <i>door/window objects: sill height, according to current settings</i> • <i>slab: the elevation of the chosen reference plane of the slab, according to settings</i> • <i>other elements/objects: the base elevation, according to settings</i> 											

GLOB_ELEM_TYPE		element type, for labels and property objects contains the type of the parent element									
<i>0 - none (individual label), 1 - object, 2 - lamp, 3 - window, 4 - door, 5 - wall, 6 - column, 7 - slab, 8 - roof, 9 - fill, 10 - mesh, 11 - zone, 12 - beam, 13 - curtain wall, 14 - curtain wall frame, 15 - curtain wall panel, 16 - curtain wall junction, 17 - curtain wall accessory, 18 - shell, 19 - skylight, 20 - morph, 21 - stair, 22 - stair tread, 23 - stair riser, 24 - stair structure, 25 - railing, 26 - opening, 27 - column segment, 28 - beam segment.</i>											

Object, Lamp, Door, Window, Wall End, Skylight parameters

SYMB_LINETYPE	line type of the library part <i>applied as the default line type of the 2D symbol</i>
SYMB_FILL	fill type of the library part <i>applied on cut surfaces of library parts in section/elevation windows</i>
SYMB_FILL_PEN	pen of the fill of the library part <i>applied on cut surfaces of library parts in section/elevation windows</i>
SYMB_FBGD_PEN	pen of the background of the fill of the library part <i>applied on cut surfaces of library parts in section/elevation windows</i>
SYMB_SECT_PEN	pen of the library part in section <i>applied on contours of cut surfaces of library parts in section/elevation windows</i>
SYMB_VIEW_PEN	default pen of the library part <i>applied on all edges in 3D window and on edges on view in section/elevation windows</i>
SYMB_MAT	default surface attribute index of the library part
SYMB_POS_X	position of the library part (x) <i>relative to the project origin (excluding door, window and wall end: relative to the startpoint of the including wall)</i>
SYMB_POS_Y	position of the library part (y) <i>relative to the project origin (excluding door, window and wall end: relative to the startpoint of the including wall) Note: see the section called “Doors and Windows” for orientation of Y and Z axes</i>
SYMB_POS_Z	position of the library part (z) <i>relative to the project origin (excluding door, window and wall end: relative to the startpoint of the including wall) Note: see the section called “Doors and Windows” for orientation of Y and Z axes</i>
SYMB_ROTANGLE	rotation angle of the library part <i>numeric rotation from within the settings dialog is performed around the current anchor point</i>

SYMB_MIRRORED

library part mirrored

0-no, 1-yes (mirroring is performed around the current anchor point.) Always 0 for wall ends, except when the origin of the local coordinate system is in a non-rectangular vertex of a trapezoidal wall's polygon.

Object, Lamp, Door, Window, Wall End, Skylight, Curtain Wall Accessory parameters - available for listing and labels only

SYMB_A_SIZE

nominal length/width of library part

length of object/lamp, width of window/door (fixed parameter), width of accessory

SYMB_B_SIZE

nominal width/height of library parts

width of object/lamp, height of window/door (fixed parameter), height of accessory

Object, Lamp, Curtain Wall Accessory parameters - available for listing and labels only

SYMB_Z_SIZE

nominal height/length of the library part

length of accessory or if a user parameter is named in $\$P\X format then it will be used for nominal height, otherwise 0

Opening parameters - available for listing and labels only

OPENING_HEIGHT

length, nominal height of the opening

2D	✓	3D	⊖	UI	⊖	Parameter	⊖	Property	⊖	Default	1
----	---	----	---	----	---	-----------	---	----------	---	---------	---

Compatibility: introduced in ARCHICAD 23.

OPENING_WIDTH

length, nominal width of the opening

2D	✓	3D	⊖	UI	⊖	Parameter	⊖	Property	⊖	Default	1
----	---	----	---	----	---	-----------	---	----------	---	---------	---

Compatibility: introduced in ARCHICAD 23.

OPENING_HEADERHEIGHT_VALUES dictionary, relative elevation of the header of the opening (or topmost point if rotated) from specific reference levels

2D	✔	3D	✘	UI	✘	Parameter	✘	Property	✘	Default	{}
----	---	----	---	----	---	-----------	---	----------	---	---------	----

Compatibility: introduced in ARCHICAD 23.

```
{
  "toHomeStory": 1.5,
  "toProjectZero": 1.5,
  "toWallBottom": 1.5,
  "toWallTop": 1.5
}
```

OPENING_CENTERHEIGHT_VALUES dictionary, relative elevation of the center of the opening from specific reference levels

2D	✔	3D	✘	UI	✘	Parameter	✘	Property	✘	Default	{}
----	---	----	---	----	---	-----------	---	----------	---	---------	----

Compatibility: introduced in ARCHICAD 23.

```
{
  "toHomeStory": 1.0,
  "toProjectZero": 1.0,
  "toWallBottom": 1.0,
  "toWallTop": 2.0
}
```

OPENING_SILLHEIGHT_VALUES dictionary, relative elevation of the sill of the opening (or lowest point if rotated) from specific reference levels

2D	✔	3D	✘	UI	✘	Parameter	✘	Property	✘	Default	{}
----	---	----	---	----	---	-----------	---	----------	---	---------	----

Compatibility: introduced in ARCHICAD 23.

```
{
  "toHomeStory": 0.5,
  "toProjectZero": 0.5,
  "toWallBottom": 0.5,
  "toWallTop": 0.5
}
```

Opening symbol parameters

OPENING_SYMBOL_DISPLAY integer, visibility of the opening symbol according to the Floor Plan Cut Plane (view dependent, do not use in parameter/property scripts)

2D	✓	3D	✓	UI	✗	Parameter	✗	Property	✗	Default	1
----	---	----	---	----	---	-----------	---	----------	---	---------	---

Compatibility: introduced in ARCHICAD 23.

1 - visible, 2 - hidden, 3 - overhead

OPENING_SYMBOL_GEOMETRY dictionary, contains the geometry of the symbol (view dependent, do not use in parameter/property scripts)

2D	✓	3D	✗	UI	✗	Parameter	✗	Property	✗	Default	{}
----	---	----	---	----	---	-----------	---	----------	---	---------	----

Compatibility: introduced in ARCHICAD 23.

- `.boundingBox2D{ }`: (dictionary) bounding box definition of the opening polygon, always aligned with the opening symbol coordinate system.
- `.boundingBox2D.xmin`
- `.boundingBox2D.xmax`
- `.boundingBox2D.ymin`
- `.boundingBox2D.ymax`
- `.polygon2D{ }`: (dictionary) projected polygon of the opening cut by the geometry of the parent element
- `.polygon2D.isClosed`: (boolean) always 1 in case of a polygon (0 - reserved for future developments)
- `.polygon2D.contour{ }`: (dictionary) contains data of the polygon contour. The default polygon corresponds to the rectangle in `.boundingBox2D{ }`
- `.polygon2D.contour.edges[n]`: (array) contains an embedded dictionary for each edge of the polygon
- `.polygon2D.contour.edges[n].type`: (integer) 0 - straight, 1 - curved (circular arc)
- `.polygon2D.contour.edges[n].begPoint{ }`: (dictionary) an embedded dictionary for the coordinates of the beginning point of the edge
- `.polygon2D.contour.edges[n].arcAngle`: (angle) central angle of the edge curve, positive counter-clockwise, negative clockwise (not set for straight edges)
- `.polygon2D.holes[m]`: (array) contains data of inner holes, similar to `.contour`, only set when holes exist

```
OPENING_SYMBOL_GEOMETRY: {
  "boundingBox2D": {
    "xmin": 0,
    "xmax": 1,
    "ymin": 0,
    "ymax": 1
  },
  "polygon2D": {
    "isClosed": 1,
    "contour": {
      "edges": [
        {
          "type": 1,
          "begPoint": {
            "x": 1,
            "y": 0.5
          },
          "arcAngle": 90
        },
        {
          "type": 1,
          "begPoint": {
            "x": 0.5,
            "y": 1
          },
          "arcAngle": 90
        },
        {
          "type": 1,
          "begPoint": {
            "x": 0,
            "y": 0.5
          },
          "arcAngle": 90
        }
      ]
    }
  }
}
```

```
{
  "type": 1,
  "begPoint": {
    "x": 0.5,
    "y": 0
  },
  "arcAngle": 90
}
]
},
"holes": {
  "edges": [
    {
      "type": 0,
      "begPoint": {
        "x": 0.4,
        "y": 0.4
      },
    },
    {
      "type": 0,
      "begPoint": {
        "x": 0.4,
        "y": 0.6
      },
    },
    {
      "type": 0,
      "begPoint": {
        "x": 0.6,
        "y": 0.6
      },
    },
  ],
}
```

```

    {
      "type": 0,
      "begPoint": {
        "x": 0.6,
        "y": 0.4
      },
    },
  ]
}

```

Window, Door and Wall End parameters

WIDO_REVEAL_ON	window/door built-in reveal is on <i>0-reveal is off, 1-reveal is on</i>
WIDO_SILL	sill depth of the window/door - sometimes referred to as reveal depth <i>for curved walls: in radial direction at nominal sized opening corner</i>
WIDO_SILL_HEIGHT	window/door nominal sill height
WIDO_RSIDE_SILL_HEIGHT	window/door sill height on the reveal side
WIDO_OPRSIDE_SILL_HEIGHT	window/door sill height on the side opposite to the reveal side
WIDO_RIGHT_JAMB	window/door built-in jamb on the right side
WIDO_LEFT_JAMB	window/door built-in jamb on the left side
WIDO_THRES_DEPTH	window/door built-in sill/threshold depth
WIDO_HEAD_DEPTH	window/door built-in head depth
WIDO_HEAD_HEIGHT	window/door nominal head height
WIDO_RSIDE_HEAD_HEIGHT	window/door head height on the reveal side
WIDO_OPRSIDE_HEAD_HEIGHT	window/door head height on the side opposite to the reveal side
WIDO_REVEAL_SIDE	reveal side is opposite to the opening side <i>1=yes, 0=no - when placing an element, the default value is 0 for windows, 1 for doors</i>

WIDO_FRAME_THICKNESS	frame thickness of window/door <i>when flipping doors/windows, they will be mirrored then relocated automatically by this value</i>
WIDO_POSITION	offset of the door/window <i>angle or distance between the axis of the opening or wall end and the normal vector at the wall's starting point</i>
WIDO_ORIENTATION	window/door opening orientation <i>left/right - it will work fine only if the door/window was created according to local standards</i>
WIDO_MARKER_TXT	window/door marker text
WIDO_SUBFL_THICKNESS	subfloor thickness (for sill height correction)
WIDO_PREFIX	window/door sill height prefix
WIDO_CUSTOM_MARKER	window/door custom marker switch <i>1-parameters can be used in the 2D script while the automatic dimension is not present</i>
WIDO_ORIG_DIST	distance of the local origin from the center of curvature of the wall <i>distance of the local origin from the centerpoint of the curved wall, 0 for straight walls. Negative for wall ends at the ending point of the curved wall.</i>
WIDO_PWALL_INSET	parapet wall inset

Window, Door parameters - available for listing and labels only

WIDO_RSIDE_WIDTH	window/door opening width on the reveal side
WIDO_OPRSIDE_WIDTH	window/door opening width on the side opposite to the reveal side
WIDO_RSIDE_HEIGHT	window/door opening height on the reveal side
WIDO_OPRSIDE_HEIGHT	window/door opening height on the side opposite to the reveal side
WIDO_RSIDE_SURF	window/door opening surface area on the reveal side
WIDO_OPRSIDE_SURF	window/door opening surface area on the side opposite to the reveal side
WIDO_N_RSIDE_WIDTH	nominal window/door opening width on the reveal side
WIDO_N_OPRSIDE_WIDTH	nominal window/door opening width on the side opposite to the reveal side
WIDO_N_RSIDE_HEIGHT	nominal window/door opening height on the reveal side

WIDO_N_OPRSIDE_HEIGHT	nominal window/door opening height on the side opposite to the reveal side
WIDO_N_RSIDE_SURF	nominal window/door opening surface on the reveal side
WIDO_N_OPRSIDE_SURF	nominal window/door opening surface on the side opposite to the reveal side
WIDO_VOLUME	window/door opening volume
WIDO_GROSS_SURFACE	window/door opening nominal surface area
WIDO_GROSS_VOLUME	window/door opening nominal volume

Lamp parameters - available for listing and labels only

LIGHT_ON	light is on <i>0-light is off, 1-light is on</i>
LIGHT_RED	red component of the light color
LIGHT_GREEN	green component of the light color
LIGHT_BLUE	blue component of the light color
LIGHT_INTENSITY	light intensity

Marker parameters (Detail, Worksheet and Change Markers)

MARKER_HEAD_ROT_MODE	integer type global, set according to function "Marker Angle: Fixed Angle to Screen/Fixed Angle to Model" on Marker panel of the Settings Dialog									
-----------------------------	--	--	--	--	--	--	--	--	--	--

2D	✓	3D	✓	UI	✓	Parameter	✓	Property	✓	Default	1
----	---	----	---	----	---	-----------	---	----------	---	---------	---

can be used to react to marker head rotation settings of ARCHICAD on GDL symbol side

1 - Fixed Angle to Screen, 2 - Fixed Angle to Model

Compatibility: introduced in ARCHICAD 22.

MARKER_HEAD_ANGLE

angle type global, set by the user on Marker panel of the Settings Dialog

2D	✓	3D	✓	UI	✓	Parameter	✓	Property	✓	Default	0
----	---	----	---	----	---	-----------	---	----------	---	---------	---

marker head symbol rotation data for GDL symbol part of the marker

Compatibility: introduced in ARCHICAD 22.

In Detail/Worksheet marker objects, SYMB_ROTANGLE value stays compatible with this new angle data:

- "Fixed Angle to Screen" mode: 1 - SYMB_ROTANGLE is the opposite of view rotation angle
- "Fixed Angle to Model" mode: 2 - SYMB_ROTANGLE equals MARKER_HEAD_ANGLE

In Change marker objects, SYMB_ROTANGLE value stays 0 as before in all cases.

Label parameters**LABEL_POSITION**

position of the label

2D	✓	3D	✓	UI	✓	Parameter	✗	Property	✗	Default	0
----	---	----	---	----	---	-----------	---	----------	---	---------	---

array[3][2] containing the coordinates of the 3 points defining the label pointer and the starting position of the label GDL symbol.

Compatibility: parameter and property script restrictions are introduced in ARCHICAD 22.

View-dependent value in case of "Fixed Angle" ON. Project-dependent in case "Label Orientation" is set to "Parallel" or "Perpendicular", and the parent element is moved, thus changing the value of the variable while not running the parameter script of the label itself (can not be stored as parameter).

LABEL_ASSOC_ELEM_ORIENTATION

orientation of the associated element

2D	✓	3D	✓	UI	✓	Parameter	✗	Property	✗	Default	0
----	---	----	---	----	---	-----------	---	----------	---	---------	---

- *straight elements: the direction of the reference line*
- *curved elements: the direction of the chord of the arc*
- *point-like elements: the rotation angle of the element*

Compatibility: parameter and property script restrictions are introduced in ARCHICAD 22.

Project-dependent: the parent element can be moved, thus changing the value of the variable while not running the parameter script of the label itself (can not be stored as parameter).

LABEL_ROTANGLE

absolute rotation angle data for GDL symbol type labels

2D	✓	3D	✓	UI	✓	Parameter	✗	Property	✗	Default	0
----	---	----	---	----	---	-----------	---	----------	---	---------	---

The angle is calculated according to Label Orientation, Fixed Angle, and readability settings.

Compatibility: parameter and property script restrictions are introduced in ARCHICAD 22.

View-dependent value in case of "Fixed Angle" ON. Project-dependent in case "Label Orientation" is set to "Parallel" or "Perpendicular": the parent element can be moved, thus changing the value of the variable.

LABEL_ARROWHEAD_PEN

pen of the arrowhead

LABEL_HAS_POINTER

Boolean

1 - "Add/ Remove Pointer" is checked on "Label Settings/ Pointer" panel, 0 otherwise.

Compatibility: introduced in ARCHICAD 22. The similar, reverse-working global variable "LABEL_CUSTOM_ARROW" is considered deprecated since ARCHICAD 22.

Wall parameters - available for Doors/Windows, listing and labels

WALL_ID

user ID of the wall

WALL_INTGUID

internal GUID of the wall

the internal GUID generated by the program (cannot be controlled by the user)

WALL_RESOL

3D resolution of a curved wall

effective in 3D only

WALL_THICKNESS

thickness of the wall

in case of inclined walls: the wall thickness at the opening axis (local z axis)

WALL_START_THICKNESS

Start thickness of the wall

WALL_END_THICKNESS

End thickness of the wall

WALL_INCL

inclination of the wall surfaces

the angle between the two inclined wall surfaces - 0 for common straight walls

WALL_FLIPPED	boolean value set according to "Reference Line Location: Flip Wall on Reference Line" option of the wall										
2D	✓	3D	✓	UI	✓	Parameter	✓	Property	✓	Default	0
<i>information about the flipped state of the current wall</i> <i>0 - default wall position, 1 - wall is flipped on reference line</i> <i>Compatibility: introduced in ARCHICAD 22.</i>											
WALL_HEIGHT	height of the wall										
WALL_MAT_A	surface attribute index of the wall on the side opposite to the opening side										
WALL_MAT_B	surface attribute index of the wall on the opening side										
<i>this can vary from opening to opening placed in the same wall</i>											
WALL_MAT_EDGE	surface attribute index of the edges of the wall										
WALL_LINETYPE	line type of the wall										
<i>applied on the contours only in the floor plan window</i>											
WALL_FILL	fill type of the wall										
<i>fill index, first skin of a composite structure</i>											
WALL_FILL_PEN	pen of the wall fill										
WALL_COMPS_NAME	name of the composite or complex structure of the wall										
<i>the name of the profile attribute for complex wall, the name of the composite attribute for composite walls, empty string otherwise.</i>											
WALL_BMAT_NAME	name of the building material of the wall										
<i>building material name of the wall, empty string for composite or complex walls.</i>											
WALL_BMAT	index of the building material of the wall										
<i>Compatibility: introduced in ARCHICAD 21.</i>											
<i>building material index of the wall, 0 for composite or complex walls.</i>											
WALL_SKINS_NUMBER	number of composite or complex wall skins										
<i>range of 1 to 127, 0 if single fill applied</i>											

WALL_SKINS_PARAMS

parameters of the composite or complex wall skins

array with 19 columns with arbitrary number of rows:

- [1] fill
- [2] thickness
- [3] (old contour pen)
- [4] pen of fill
- [5] pen of fill background
- [6] core status
- [7] upper line pen
- [8] upper line type
- [9] lower line pen
- [10] lower line type
- [11] end face pen
- [12] fill orientation
- [13] skin type
- [14] end face line type
- [15] finish skin status
- [16] oriented fill status
- [17] trapezoid/ double slanted status
- [18] building material index
- [19] skin edge surface index (considering wall edge surface override). *Compatibility: introduced in ARCHICAD 22.*

*core status: 0 - not part, 1 - part, 3 - last core skin.**fill orientation: 0 - global, 1 - local.**skin type: 0 - cut, 1 - below cutplane, 2 - above cutplane (all skin types are 0 for simple walls).**trapezoid/ double slanted: 0 - this skin has parallel faces in all circumstances, 1 - this skin might have non-parallel faces to adjust for the width difference of trapezoid walls or double slanted walls. Even if the wall faces are parallel, this flag can be turned on.**finish skin status: 0 - not finish skin, 1 - finish skin.**oriented fill status: 0 - global or local fill orientation as set in the "fill orientation" column, 1 - fill orientation and size match with the wall skin direction and thickness.**For complex walls this variable contains only the data of the skins that are cut on the floor plan (2D - regarding floor plan cut height), or cut at D/W sill / wall end bottom height (3D).***WALL_SKINS_BMAT_NAMES**

building material names of the composite or complex wall skins

*array with 1 column: building material name of the skin and with arbitrary number of rows.**For D/W and wall ends in the 3D window contains the data of the skins actually cut by the D/W or wall end.*

WALL_SECT_PEN	pen of the contours of the wall cut surfaces <i>applied on contours of cut surfaces both in floor plan and section/ elevation windows</i>
WALL_VIEW_PEN	pen of the contours of the wall on view <i>applied on all edges in 3D window and on outline edges (edges on view below cutting plane) in floor plan and section/ elevation window</i>
WALL_FBGD_PEN	pen of the background of the fill of the wall
WALL_DIRECTION	direction of the wall <i>straight walls: the direction of the reference line, curved walls: the direction of the chord of the arc</i>
WALL_POSITION	absolute coordinates of the wall <i>array with 3 columns: x, y, z, which means the position of the wall's starting point relative to the project origin</i>
WALL_TEXTURE_WRAP	texture wrapping data of the wall to be used in VERT and COOR{2}, or COOR{3} commands. The wall texture coordinates are transformed to match the local coordinate system of the wall-connected object (no additional transformations needed). <i>array with 14 rows:</i> <ul style="list-style-type: none"> • [1]: <i>wrapping_method</i> • [2]: <i>wrap_flags</i> • [3]-[4]-[5]: <i>origin_X, origin_Y, origin_Z (nodes of vert 1)</i> • [6]-[7]-[8]: <i>endOfX_X, endOfX_Y, endOfX_Z (nodes of vert 2)</i> • [9]-[10]-[11]: <i>endOfY_X, endOfY_Y, endOfY_Z (nodes of vert 3)</i> • [12]-[13]-[14]: <i>endOfZ_X, endOfZ_Y, endOfZ_Z (nodes of vert 4)</i>

Wall parameters - available for listing and labels only

WALL_LENGTH_A	length of the wall on the reference line side
WALL_LENGTH_B	length of the wall on the side opposite to the reference line
WALL_LENGTH_A_CON	conditional wall length on the reference line side
WALL_LENGTH_B_CON	conditional wall length on the side opposite to the reference line
WALL_CENTER_LENGTH	length of the wall at the center
WALL_AREA	area of the wall
WALL_PERIMETER	perimeter of the wall

WALL_SURFACE_A	surface area of the wall on the reference line side
WALL_SURFACE_B	surface area of the wall on the side opposite to the reference line
WALL_SURFACE_A_CON	conditional wall surface area on the reference line side
WALL_SURFACE_B_CON	conditional wall surface area on the side opposite to the reference line
WALL_GROSS_SURFACE_A	gross surface area of the wall on the reference line side
WALL_GROSS_SURFACE_B	gross surface area of the wall on the side opposite to the reference line
WALL_EDGE_SURF	surface area of the edge of the wall
WALL_VOLUME	volume of the wall
WALL_VOLUME_CON	conditional volume of the wall
WALL_GROSS_VOLUME	gross volume of the wall
WALL_VOLUME_A	wall skin volume on the reference line side
WALL_VOLUME_A_CON	conditional wall skin volume on the reference line side
WALL_VOLUME_B	wall skin volume on the side opposite to the reference line
WALL_VOLUME_B_CON	conditional wall skin volume on the side opposite to the reference line
WALL_DOORS_NR	number of doors in the wall
WALL_WINDS_NR	number of windows in the wall
WALL_HOLES_NR	number of empty openings
WALL_DOORS_SURF	surface area of doors in the wall
WALL_WINDS_SURF	surface area of windows in the wall
WALL_HOLES_SURF	surface area of empty openings in the wall
WALL_HOLES_SURF_A	analytic surface area of openings on the reference line side
WALL_HOLES_SURF_B	analytic surface area of openings on the opposite side
WALL_HOLES_VOLUME	analytic volume of openings in the wall
WALL_WINDS_WID	combined width of the windows in the wall
WALL_DOORS_WID	combined width of the doors in the wall

WALL_COLUMNS_NR	number of columns in the wall
WALL_CROSSSECTION_TYPE	cross-section type of the wall <i>0 - complex profiled, 1 - rectangular, 2 - slanted, 3 - double slanted</i>
WALL_MIN_HEIGHT	minimum height of the wall
WALL_MAX_HEIGHT	maximum height of the wall
WALL_SKIN_MIN_HEIGHT_A	minimum height of the wall skin on the reference line side
WALL_SKIN_MAX_HEIGHT_A	maximum height of the wall skin on the reference line side
WALL_SKIN_MIN_HEIGHT_B	minimum height of the wall skin on the reference line side
WALL_SKIN_MAX_HEIGHT_B	maximum height of the wall skin on the side opposite to the reference line
WALL_SKIN_THICKNESS_A	wall skin thickness on the reference line side
WALL_SKIN_THICKNESS_B	wall skin thickness on the side opposite to the reference line
WALL_INSU_THICKNESS	wall insulation skin thickness
WALL_AIR_THICKNESS	wall air skin thickness

Column parameters - available for listing and labels only

Compatibility: From ARCHICAD 23, the Column element is a collection of Column Segments. GLOB_ELEM_TYPE has a new value for Column segments: 27, the value of the Column element remains 6.

The availability of each global variable (whether it contains meaningful data) is shown in a table with icons, with the value of the GLOB_ELEM_TYPE global variable in parentheses.

COLU_SEGMENT_INDEX	index of Column Segment in COLU_SEGMENT_INFO.segments[] array		
 <i>Column Segment (27)</i>	 <i>Single-segment Column (6)</i>	 <i>Multi-segment Column (6)</i>	

Compatibility: introduced in ARCHICAD 23.

COLU_SEGMENT_INFO

dictionary, contains all the Column Segments' geometric settings which can determine the availability of other global variables. Not available in parameter and property scripts.

When placed on a Column Segment, `COLU_SEGMENT_INFO.segments[COLU_SEGMENT_INDEX]` contains the information about the labeled segment.

- `.segments[n].tapered`: (integer): 0 - uniform cross-section, 1 - tapered cross-section
- `.segments[n].crossSection{}`: (dictionary) cross-section data of segment
- `.segments[n].crossSection.type`: (integer) cross-section type: 1 - rectangular, 2 - circular, 3 - complex profile
- `.segments[n].crossSection.startWidth`: (length) bounding cross-section width of the start of the segment. The direction of the segment is defined by its reference line.
- `.segments[n].crossSection.startHeight`: (length) bounding cross-section height of the start of the segment. The direction of the segment is defined by its reference line.
- `.segments[n].crossSection.endWidth`: (length) bounding cross-section width of the end of the segment. The direction of the segment is defined by its reference line.
- `.segments[n].crossSection.endHeight`: (length) bounding cross-section height of the end of the segment. The direction of the segment is defined by its reference line.

✓ Column Segment (27)	✓ Single-segment Column (6)	✓ Multi-segment Column (6)
-----------------------	-----------------------------	----------------------------

Compatibility: introduced in ARCHICAD 23.

COLU_CORE

core/veneer properties (0 in case of tapered column segment)

✓ Column Segment (27)	✓ Single-segment Column (6)	✗ Multi-segment Column (6)
-----------------------	-----------------------------	----------------------------

serves compatibility: it is only effective in the properties script of .CPS (Column.Properties) files

COLU_HEIGHT

height of the column

✓ Column Segment (27)	✓ Single-segment Column (6)	✓ Multi-segment Column (6)
-----------------------	-----------------------------	----------------------------

COLU_MIN_HEIGHT

Minimum height of the column

✓ Column Segment (27)	✓ Single-segment Column (6)	✓ Multi-segment Column (6)
-----------------------	-----------------------------	----------------------------

COLU_MAX_HEIGHT

Maximum height of the column

✓ Column Segment (27)	✓ Single-segment Column (6)	✓ Multi-segment Column (6)
-----------------------	-----------------------------	----------------------------

COLU_VENEER_WIDTH	thickness of the column veneer	
<input checked="" type="checkbox"/> <i>Column Segment (27)</i>	<input checked="" type="checkbox"/> <i>Single-segment Column (6)</i>	<input type="checkbox"/> <i>Multi-segment Column (6)</i>
COLU_CORE_X	Width of the core (0 in case of tapered column segment)	
<input checked="" type="checkbox"/> <i>Column Segment (27)</i>	<input checked="" type="checkbox"/> <i>Single-segment Column (6)</i>	<input type="checkbox"/> <i>Multi-segment Column (6)</i>
COLU_CORE_Y	Depth of the core (0 in case of tapered column segment)	
<input checked="" type="checkbox"/> <i>Column Segment (27)</i>	<input checked="" type="checkbox"/> <i>Single-segment Column (6)</i>	<input type="checkbox"/> <i>Multi-segment Column (6)</i>
COLU_DIM1	1st dimension of the column (0 in case of tapered column segment) - only for labels	
<input checked="" type="checkbox"/> <i>Column Segment (27)</i>	<input checked="" type="checkbox"/> <i>Single-segment Column (6)</i>	<input type="checkbox"/> <i>Multi-segment Column (6)</i>
COLU_DIM2	2nd dimension of the column (0 in case of tapered column segment) - only for labels	
<input checked="" type="checkbox"/> <i>Column Segment (27)</i>	<input checked="" type="checkbox"/> <i>Single-segment Column (6)</i>	<input type="checkbox"/> <i>Multi-segment Column (6)</i>
COLU_MAT	surface attribute index of the column	
<input checked="" type="checkbox"/> <i>Column Segment (27)</i>	<input checked="" type="checkbox"/> <i>Single-segment Column (6)</i>	<input type="checkbox"/> <i>Multi-segment Column (6)</i>
<i>Wall wrapping will replace column surface with the surfaces of the connecting walls</i>		
COLU_LINETYPE	line type of the column	
<input checked="" type="checkbox"/> <i>Column Segment (27)</i>	<input checked="" type="checkbox"/> <i>Single-segment Column (6)</i>	<input checked="" type="checkbox"/> <i>Multi-segment Column (6)</i>
<i>applied on the contours only in the floor plan window</i>		
COLU_CORE_FILL	fill of the column core	
<input checked="" type="checkbox"/> <i>Column Segment (27)</i>	<input checked="" type="checkbox"/> <i>Single-segment Column (6)</i>	<input type="checkbox"/> <i>Multi-segment Column (6)</i>
COLU_CORE_BMAT_NAME	building material name of the column core	
<input checked="" type="checkbox"/> <i>Column Segment (27)</i>	<input checked="" type="checkbox"/> <i>Single-segment Column (6)</i>	<input type="checkbox"/> <i>Multi-segment Column (6)</i>

COLU_CORE_BMAT building material index of the column core

✓ <i>Column Segment (27)</i>	✓ <i>Single-segment Column (6)</i>	✗ <i>Multi-segment Column (6)</i>
------------------------------	------------------------------------	-----------------------------------

Compatibility: introduced in ARCHICAD 21.

COLU_VENEER_FILL fill of the column veneer

✓ <i>Column Segment (27)</i>	✓ <i>Single-segment Column (6)</i>	✗ <i>Multi-segment Column (6)</i>
------------------------------	------------------------------------	-----------------------------------

COLU_VENEER_BMAT_NAME building material name of the column veneer

✓ <i>Column Segment (27)</i>	✓ <i>Single-segment Column (6)</i>	✗ <i>Multi-segment Column (6)</i>
------------------------------	------------------------------------	-----------------------------------

COLU_VENEER_BMAT building material index of the column veneer

✓ <i>Column Segment (27)</i>	✓ <i>Single-segment Column (6)</i>	✗ <i>Multi-segment Column (6)</i>
------------------------------	------------------------------------	-----------------------------------

Compatibility: introduced in ARCHICAD 21.

COLU_SECT_PEN pen of the contours of the column cut surfaces

✓ <i>Column Segment (27)</i>	✓ <i>Single-segment Column (6)</i>	✓ <i>Multi-segment Column (6)</i>
------------------------------	------------------------------------	-----------------------------------

applied on contours of cut surfaces in both floor plan and section/ elevation windows

COLU_VIEW_PEN pen of the column on view

✓ <i>Column Segment (27)</i>	✓ <i>Single-segment Column (6)</i>	✓ <i>Multi-segment Column (6)</i>
------------------------------	------------------------------------	-----------------------------------































applied on all edges in 3D window and on outline edges (edges on view below cutting plane) in floor plan and section/ elevation windows































COLU_CORE_FILL_PEN pen of the fill of the column core

✓ <i>Column Segment (27)</i>	✓ <i>Single-segment Column (6)</i>	✗ <i>Multi-segment Column (6)</i>
------------------------------	------------------------------------	-----------------------------------

COLU_CORE_FBGD_PEN pen of the background of the fill of the column core

✓ <i>Column Segment (27)</i>	✓ <i>Single-segment Column (6)</i>	✗ <i>Multi-segment Column (6)</i>
------------------------------	------------------------------------	-----------------------------------

COLU_VENEER_FILL_PEN	pen of the fill of the column veneer		
 <i>Column Segment (27)</i>	 <i>Single-segment Column (6)</i>	 <i>Multi-segment Column (6)</i>	
COLU_VENEER_FBGD_PEN	pen of the background of the fill of the column veneer		
 <i>Column Segment (27)</i>	 <i>Single-segment Column (6)</i>	 <i>Multi-segment Column (6)</i>	
COLU_PERIMETER	Perimeter of the column		
 <i>Column Segment (27)</i>	 <i>Single-segment Column (6)</i>	 <i>Multi-segment Column (6)</i>	
COLU_AREA	Area of the column		
 <i>Column Segment (27)</i>	 <i>Single-segment Column (6)</i>	 <i>Multi-segment Column (6)</i>	
COLU_VOLUME	Volume of the column		
 <i>Column Segment (27)</i>	 <i>Single-segment Column (6)</i>	 <i>Multi-segment Column (6)</i>	
COLU_GROSS_VOLUME	Gross volume of the column		
 <i>Column Segment (27)</i>	 <i>Single-segment Column (6)</i>	 <i>Multi-segment Column (6)</i>	
COLU_CORE_SURF	surface area of the column core		
 <i>Column Segment (27)</i>	 <i>Single-segment Column (6)</i>	 <i>Multi-segment Column (6)</i>	
COLU_CORE_GROSS_SURF	Gross surface area of the column		
 <i>Column Segment (27)</i>	 <i>Single-segment Column (6)</i>	 <i>Multi-segment Column (6)</i>	
COLU_CORE_VOL	volume of the column core		
 <i>Column Segment (27)</i>	 <i>Single-segment Column (6)</i>	 <i>Multi-segment Column (6)</i>	
COLU_CORE_GROSS_VOL	Gross volume of the core		
 <i>Column Segment (27)</i>	 <i>Single-segment Column (6)</i>	 <i>Multi-segment Column (6)</i>	

COLU_VENEER_SURF	surface area of the column veneer		
 <i>Column Segment (27)</i>	 <i>Single-segment Column (6)</i>	 <i>Multi-segment Column (6)</i>	
COLU_VENEER_GROSS_SURF	Gross surface area of the veneer		
 <i>Column Segment (27)</i>	 <i>Single-segment Column (6)</i>	 <i>Multi-segment Column (6)</i>	
COLU_VENEER_VOL	volume of the column veneer		
 <i>Column Segment (27)</i>	 <i>Single-segment Column (6)</i>	 <i>Multi-segment Column (6)</i>	
COLU_VENEER_GROSS_VOL	Gross volume of the veneer		
 <i>Column Segment (27)</i>	 <i>Single-segment Column (6)</i>	 <i>Multi-segment Column (6)</i>	
COLU_CORE_TOP_SURF	Surface area of the core top		
 <i>Column Segment (27)</i>	 <i>Single-segment Column (6)</i>	 <i>Multi-segment Column (6)</i>	
COLU_CORE_BOT_SURF	Surface area of the core bottom		
 <i>Column Segment (27)</i>	 <i>Single-segment Column (6)</i>	 <i>Multi-segment Column (6)</i>	
COLU_VENEER_TOP_SURF	Surface area of the veneer top		
 <i>Column Segment (27)</i>	 <i>Single-segment Column (6)</i>	 <i>Multi-segment Column (6)</i>	
COLU_VENEER_BOT_SURF	Surface area of the veneer bottom		
 <i>Column Segment (27)</i>	 <i>Single-segment Column (6)</i>	 <i>Multi-segment Column (6)</i>	
COLU_CORE_GROSS_TOPBOT_SURF	Gross surface area of the core top and bottom		
 <i>Column Segment (27)</i>	 <i>Single-segment Column (6)</i>	 <i>Multi-segment Column (6)</i>	
COLU_VENEER_GROSS_TOPBOT_SURF	Gross surface area of the veneer top and bottom		
 <i>Column Segment (27)</i>	 <i>Single-segment Column (6)</i>	 <i>Multi-segment Column (6)</i>	

COLU_PROFILE_NAME name of the profile of the column, if complex



Column Segment (27)



Single-segment Column (6)



Multi-segment Column (6)

Beam parameters - available for listing and labels only

Compatibility: From ARCHICAD 23, the Beam element is a collection of Beam Segments. GLOB_ELEM_TYPE has a new value for Beam segments: 28, the value of the Beam element remains 12.

The availability of each global variable (whether it contains meaningful data) is shown in a table with icons, with the value of the GLOB_ELEM_TYPE global variable in parentheses.

BEAM_SEGMENT_INDEX index of Beam Segment in BEAM_SEGMENT_INFO.segments[] array



Beam Segment (28)



Single-segment Beam (12)



Multi-segment Beam (12)

Compatibility: introduced in ARCHICAD 23.

BEAM_SEGMENT_INFO

dictionary, contains all the Beam Segments' geometric settings which can determine the availability of other global variables, and further Beam Segment geometric data. Not available in parameter and property scripts.

When placed on a Beam Segment, `BEAM_SEGMENT_INFO.segments[BEAM_SEGMENT_INDEX]` contains the information about the labeled segment.

- `.segments[n].curvature`: axis curvature (integer): 0 - straight, 1 - horizontally curved, 2 - vertically curved
- `.segments[n].tapered`: (integer): 0 - uniform cross-section, 1 - tapered cross-section
- `.segments[n].refLineLength`: 3D length of the beam segment reference line (length)
- `.segments[n].crossSection{ }`: (dictionary) cross-section data of segment
- `.segments[n].crossSection.type`: (integer) cross-section type: 1 - rectangular, 2 - circular, 3 - complex profile
- `.segments[n].crossSection.startWidth`: (length) bounding cross-section width of the start of the segment. The direction of the segment is defined by its reference line.
- `.segments[n].crossSection.startHeight`: (length) bounding cross-section height of the start of the segment. The direction of the segment is defined by its reference line.
- `.segments[n].crossSection.endWidth`: (length) bounding cross-section width of the end of the segment. The direction of the segment is defined by its reference line.
- `.segments[n].crossSection.endHeight`: (length) bounding cross-section height of the end of the segment. The direction of the segment is defined by its reference line.

✓ Beam Segment (28)	✓ Single-segment Beam (12)	✓ Multi-segment Beam (12)
---------------------	----------------------------	---------------------------

Compatibility: introduced in ARCHICAD 23.

BEAM_THICKNESS

thickness of the beam (0 in case of tapered beam segment)

✓ Beam Segment (28)	✓ Single-segment Beam (12)	✗ Multi-segment Beam (12)
---------------------	----------------------------	---------------------------

BEAM_HEIGHT

height of the beam (0 in case of tapered beam segment)

✓ Beam Segment (28)	✓ Single-segment Beam (12)	✗ Multi-segment Beam (12)
---------------------	----------------------------	---------------------------

BEAM_REFLINE_OFFSET

offset of the reference line relative to the axes of the beam

✓ Beam Segment (28)	✓ Single-segment Beam (12)	✓ Multi-segment Beam (12)
---------------------	----------------------------	---------------------------

BEAM_ELEVATION_TOP calculated elevation of the topmost point of the beam geometry

✓ <i>Beam Segment (28)</i>	✓ <i>Single-segment Beam (12)</i>	✓ <i>Multi-segment Beam (12)</i>
----------------------------	-----------------------------------	----------------------------------

Compatibility: introduced in ARCHICAD 22.

BEAM_ELEVATION_BOTTOM calculated elevation of the lowest point of the beam geometry

✓ <i>Beam Segment (28)</i>	✓ <i>Single-segment Beam (12)</i>	✓ <i>Multi-segment Beam (12)</i>
----------------------------	-----------------------------------	----------------------------------

Compatibility: introduced in ARCHICAD 22.

BEAM_PRIORITY 3D intersection priority index number

✓ <i>Beam Segment (28)</i>	✓ <i>Single-segment Beam (12)</i>	✗ <i>Multi-segment Beam (12)</i>
----------------------------	-----------------------------------	----------------------------------

BEAM_MAT_RIGHT surface attribute index of the beam on the right side of the reference line

✓ <i>Beam Segment (28)</i>	✓ <i>Single-segment Beam (12)</i>	✗ <i>Multi-segment Beam (12)</i>
----------------------------	-----------------------------------	----------------------------------

BEAM_MAT_LEFT surface attribute index of the beam on the left side of the reference line

✓ <i>Beam Segment (28)</i>	✓ <i>Single-segment Beam (12)</i>	✗ <i>Multi-segment Beam (12)</i>
----------------------------	-----------------------------------	----------------------------------

BEAM_MAT_TOP surface attribute index of the beam on the top

✓ <i>Beam Segment (28)</i>	✓ <i>Single-segment Beam (12)</i>	✗ <i>Multi-segment Beam (12)</i>
----------------------------	-----------------------------------	----------------------------------

BEAM_MAT_BOTTOM surface attribute index of the beam at the bottom

✓ <i>Beam Segment (28)</i>	✓ <i>Single-segment Beam (12)</i>	✗ <i>Multi-segment Beam (12)</i>
----------------------------	-----------------------------------	----------------------------------

BEAM_MAT_END surface attribute index of the beam at both ends

✓ <i>Beam Segment (28)</i>	✓ <i>Single-segment Beam (12)</i>	✗ <i>Multi-segment Beam (12)</i>
----------------------------	-----------------------------------	----------------------------------

BEAM_OUTLINE_LINETYPE line type of the beam outline

✓ <i>Beam Segment (28)</i>	✓ <i>Single-segment Beam (12)</i>	✓ <i>Multi-segment Beam (12)</i>
----------------------------	-----------------------------------	----------------------------------

BEAM_AXES_LINETYPE	line type of the beam axes		
<input checked="" type="checkbox"/> <i>Beam Segment (28)</i>	<input checked="" type="checkbox"/> <i>Single-segment Beam (12)</i>	<input checked="" type="checkbox"/> <i>Multi-segment Beam (12)</i>	
BEAM_FILL	fill type of the beam		
<input checked="" type="checkbox"/> <i>Beam Segment (28)</i>	<input checked="" type="checkbox"/> <i>Single-segment Beam (12)</i>	<input type="checkbox"/> <i>Multi-segment Beam (12)</i>	
BEAM_BMAT_NAME	building material name of the beam		
<input checked="" type="checkbox"/> <i>Beam Segment (28)</i>	<input checked="" type="checkbox"/> <i>Single-segment Beam (12)</i>	<input type="checkbox"/> <i>Multi-segment Beam (12)</i>	
BEAM_BMAT	building material index of the beam		
<input checked="" type="checkbox"/> <i>Beam Segment (28)</i>	<input checked="" type="checkbox"/> <i>Single-segment Beam (12)</i>	<input type="checkbox"/> <i>Multi-segment Beam (12)</i>	
<i>Compatibility: introduced in ARCHICAD 21.</i>			
BEAM_FILL_PEN	pen of the beam fill		
<input checked="" type="checkbox"/> <i>Beam Segment (28)</i>	<input checked="" type="checkbox"/> <i>Single-segment Beam (12)</i>	<input type="checkbox"/> <i>Multi-segment Beam (12)</i>	
BEAM_SECT_PEN	pen of the contours of the beam cut surfaces		
<input checked="" type="checkbox"/> <i>Beam Segment (28)</i>	<input checked="" type="checkbox"/> <i>Single-segment Beam (12)</i>	<input checked="" type="checkbox"/> <i>Multi-segment Beam (12)</i>	
BEAM_FBGD_PEN	pen of the background of the fill of the beam		
<input checked="" type="checkbox"/> <i>Beam Segment (28)</i>	<input checked="" type="checkbox"/> <i>Single-segment Beam (12)</i>	<input type="checkbox"/> <i>Multi-segment Beam (12)</i>	
BEAM_DIRECTION	the direction of the beam reference line		
<input checked="" type="checkbox"/> <i>Beam Segment (28)</i>	<input checked="" type="checkbox"/> <i>Single-segment Beam (12)</i>	<input checked="" type="checkbox"/> <i>Multi-segment Beam (12)</i>	
BEAM_POSITION	absolute coordinates of the beam axis starting point		
<input checked="" type="checkbox"/> <i>Beam Segment (28)</i>	<input checked="" type="checkbox"/> <i>Single-segment Beam (12)</i>	<input checked="" type="checkbox"/> <i>Multi-segment Beam (12)</i>	

BEAM_LENGTH_RIGHT length of the beam on the right side of the reference line (0 in case of tapered or vertically curved beam)

✓ Beam Segment (28)	✓ Single-segment Beam (12)	✗ Multi-segment Beam (12)
---------------------	----------------------------	---------------------------

Compatibility: deprecated for listing in ARCHICAD 23.

BEAM_LENGTH_LEFT length of the beam on the left side of the reference line (0 in case of tapered or vertically curved beam)

✓ Beam Segment (28)	✓ Single-segment Beam (12)	✗ Multi-segment Beam (12)
---------------------	----------------------------	---------------------------

Compatibility: deprecated for listing in ARCHICAD 23.

BEAM_RIGHT_SURF surface area of the beam on the right side of the reference line

✓ Beam Segment (28)	✓ Single-segment Beam (12)	✓ Multi-segment Beam (12)
---------------------	----------------------------	---------------------------

BEAM_LEFT_SURF surface area of the beam on the left side of the reference line

✓ Beam Segment (28)	✓ Single-segment Beam (12)	✓ Multi-segment Beam (12)
---------------------	----------------------------	---------------------------

BEAM_TOP_SURF surface area of the top of the beam

✓ Beam Segment (28)	✓ Single-segment Beam (12)	✓ Multi-segment Beam (12)
---------------------	----------------------------	---------------------------

BEAM_BOTTOM_SURF surface area of the bottom of the beam



















✓ Beam Segment (28)	✓ Single-segment Beam (12)	✓ Multi-segment Beam (12)
---------------------	----------------------------	---------------------------

BEAM_END_SURF surface area of both ends of the beam

✓ Beam Segment (28)	✓ Single-segment Beam (12)	✓ Multi-segment Beam (12)
---------------------	----------------------------	---------------------------

BEAM_VOLUME volume of the beam

✓ Beam Segment (28)	✓ Single-segment Beam (12)	✓ Multi-segment Beam (12)
---------------------	----------------------------	---------------------------

BEAM_VOLUME_CON	conditional volume of the beam		
 <i>Beam Segment (28)</i>	 <i>Single-segment Beam (12)</i>	 <i>Multi-segment Beam (12)</i>	
BEAM_HOLES_NR	number of holes in the beam		
 <i>Beam Segment (28)</i>	 <i>Single-segment Beam (12)</i>	 <i>Multi-segment Beam (12)</i>	
BEAM_HOLES_SURF	total surface area of holes in the beam		
 <i>Beam Segment (28)</i>	 <i>Single-segment Beam (12)</i>	 <i>Multi-segment Beam (12)</i>	
BEAM_HOLE_EDGE_SURF	total surface area of hole edges in the beam		
 <i>Beam Segment (28)</i>	 <i>Single-segment Beam (12)</i>	 <i>Multi-segment Beam (12)</i>	
BEAM_HOLES_VOLUME	total volume of holes in the beam		
 <i>Beam Segment (28)</i>	 <i>Single-segment Beam (12)</i>	 <i>Multi-segment Beam (12)</i>	
BEAM_PROFILE_NAME	name of the profile of the beam, if complex		
 <i>Beam Segment (28)</i>	 <i>Single-segment Beam (12)</i>	 <i>Multi-segment Beam (12)</i>	

Slab parameters - available for listing and labels only

SLAB_THICKNESS	thickness of the slab
SLAB_ELEVATION_TOP	top elevation of the slab
SLAB_ELEVATION_BOTTOM	bottom elevation of the slab
SLAB_MAT_TOP	surface attribute index of the top surface of the slab
SLAB_MAT_EDGE	surface attribute index of the edges of the slab
SLAB_MAT_BOTT	surface attribute index of the bottom surface of the slab
SLAB_LINETYPE	line type of the slab
SLAB_FILL	fill of the slab
	<i>fill index - its value is negative in case of a composite structure</i>

SLAB_FILL_PEN	pen of the fill of the slab
SLAB_FBGD_PEN	pen of the background of the fill of the slab
SLAB_COMPS_NAME	name of the composite structure of the slab
SLAB_BMAT_NAME	building material name of the slab, empty string for composite slabs
SLAB_BMAT	building material index of the slab, 0 for composite slabs
<i>Compatibility: introduced in ARCHICAD 21.</i>	
SLAB_SKINS_NUMBER	number of composite slab skins
<i>range of 1 to 8, 0 if single fill applied</i>	
SLAB_SKINS_PARAMS	parameters of the composite slab skins
<i>array with 18 columns with arbitrary number of rows:</i>	
<ul style="list-style-type: none"> • [1] fill • [2] thickness • [3] (old contour pen) • [4] pen of fill • [5] pen of fill background • [6] core status • [7] upper line pen • [8] upper line type • [9] lower line pen • [10] lower line type • [11] end face pen • [12] fill orientation • [13] skin type • [14] end face line type • [15] finish skin status • [16] oriented fill status • [17] core skin status (if no core skin exists, the thickest skin) • [18] building material index. 	
<i>core status: 0 - not part, 1 - part, 3 - last skin of core, fill orientation: 0 - global, 1 - local; skin type: in the current ARCHICAD always 0 - cut, it can be used as in walls later; finish skin status: 0 not finish skin, 1: finish skin</i>	

SLAB_SKINS_BMAT_NAMES	building material names of the composite slab skins <i>array with 1 column: building material name of the skin and with arbitrary number of rows.</i>
SLAB_SECT_PEN	pen of the contours of the slab in section <i>applied on contours of cut surfaces in both floor plan and section/ elevation windows</i>
SLAB_VIEW_PEN	pen of the slab <i>applied on all edges in 3D window and on visible edges in section/ elevation windows</i>
SLAB_TOP_SURF	top surface area of the slab <i>not reduced by the surface area of holes</i>
SLAB_GROSS_TOP_SURF	gross surface area of the slab top without hole <i>reduced by the surface area of holes</i>
SLAB_TOP_SURF_CON	conditional top surface area of the slab <i>reduced by the surface area of holes, which are bigger than the given value</i>
SLAB_BOT_SURF	bottom surface area of the slab without hole <i>not reduced by the surface area of holes</i>
SLAB_GROSS_BOT_SURF	gross surface area of the slab bottom <i>reduced by the surface area of holes</i>
SLAB_BOT_SURF_CON	conditional bottom surface area of the slab <i>reduced by the surface area of holes, which are bigger than the given value</i>
SLAB_EDGE_SURF	surface area of the edges of the slab <i>not reduced by the surface area of holes</i>
SLAB_GROSS_EDGE_SURF	gross surface area of the slab edges without hole <i>reduced by the surface area of holes</i>
SLAB_PERIMETER	perimeter of the slab
SLAB_VOLUME	volume of the slab <i>not reduced by the volume of holes</i>

SLAB_GROSS_VOLUME	gross volume of the slab without hole <i>reduced by the volume of holes</i>
SLAB_VOLUME_CON	conditional volume of the slab <i>reduced by the volume of holes, which are bigger than the given value</i>
SLAB_SEGMENTS_NR	number of segments of the slab
SLAB_HOLES_NR	number of holes in the slab
SLAB_HOLES_AREA	area of holes in the slab
SLAB_HOLES_PRM	perimeter of holes in the slab
SLAB_GROSS_TOP_SURF_WITH_HOLES	gross surface area of the slab top
SLAB_GROSS_BOT_SURF_WITH_HOLES	gross surface area of the slab bottom
SLAB_GROSS_EDGE_SURF_WITH_HOLES	gross surface area of the slab edges
SLAB_GROSS_VOLUME_WITH_HOLES	gross volume of the slab

Stair component parameters

General stair variables - available for listing and labels

Compatibility: introduced in ARCHICAD 21.

STAIR_AREA		projected 2D area of the stair									
2D	✓	3D	✗	UI	✓	Parameter	✓	Property	✗	Default	0
STAIR_VOLUME		area of the stair including all 3D parts									
2D	✓	3D	✗	UI	✓	Parameter	✓	Property	✗	Default	0
STAIR_HEIGHT		difference between maximum and minimum of Z coordinates									
2D	✓	3D	✗	UI	✓	Parameter	✓	Property	✗	Default	0
STAIR_WALKLINE_LENGTH		projected 2D length of the stair's walking line									
2D	✓	3D	✗	UI	✓	Parameter	✓	Property	✗	Default	0

STAIR_DEFAULT_WIDTH												default width of stair (as set in the Stair Default Settings/Geometry and Positioning panel)
2D	✓	3D	✗	UI	✓	Parameter	✓	Property	✗	Default	0	
STAIR_DEFAULT_GOING_DEPTH												default depth of going (as set in the Stair Default Settings/Geometry and Positioning panel)
2D	✓	3D	✓	UI	✓	Parameter	✓	Property	✗	Default	0	
STAIR_DEFAULT_RISER_HEIGHT												default width of riser (as set in the Stair Default Settings/Geometry and Positioning panel)
2D	✓	3D	✓	UI	✓	Parameter	✓	Property	✗	Default	0	
STAIR_DEFAULT_TREAD_THICKNESS												default tread thickness of stair (as set in the Stair Default Settings/Geometry and Positioning panel)
2D	✓	3D	✓	UI	✓	Parameter	✓	Property	✗	Default	0	
STAIR_NR_OF_TREADS_IN_FLIGHTS												integer array with one dimension ([n]) number of treads in each flight of the stair (n = number of flights)
2D	✓	3D	✗	UI	✓	Parameter	✓	Property	✗	Default	0	
STAIR_NR_OF_RISERS_IN_FLIGHTS												integer array with one dimension ([n]) number of risers in each flight of the stair (n = number of flights)
2D	✓	3D	✗	UI	✓	Parameter	✓	Property	✗	Default	0	
STAIR_NR_OF_RISERS												number of risers regarding the whole stair
2D	✓	3D	✓	UI	✓	Parameter	✓	Property	✗	Default	0	
STAIR_NR_OF_TREADS												number of treads regarding the whole stair
2D	✓	3D	✓	UI	✓	Parameter	✓	Property	✗	Default	0	
STAIR_LANDING_NUMBER												number of landing sections regarding the whole stair
2D	✓	3D	✓	UI	✓	Parameter	✓	Property	✗	Default	0	
STAIR_STAIR_GRADIENT												stair inclination: the angle of the riser/going ratio in radian
2D	✓	3D	✗	UI	✓	Parameter	✓	Property	✗	Default	0	

STAIR_RULE_LIMITS

length/angle array with two dimensions ([6][2]), collection of minimum and maximum values set in Stair Default Settings/Rules and Standards/Treads and Risers panel

2D	✓	3D	✗	UI	✓	Parameter	✓	Property	✗	Default	[0]
----	---	----	---	----	---	-----------	---	----------	---	---------	-----

Project Preferences setting of the visibility of these values does not affect the variable.

- [1][1] - [1][2]: Riser height (R) minimum and maximum value
- [2][1] - [2][2]: Going (G) minimum and maximum value
- [3][1] - [3][2]: 2 Riser + 1 Going (2*R + G) minimum and maximum value
- [4][1] - [4][2]: Riser / Going ratio (R / G) minimum and maximum value
- [5][1] - [5][2]: Riser + Going (R + G) minimum and maximum value
- [6][1] - [6][2]: Stair pitch minimum and maximum value

STAIR_RULE_FLAGS

boolean array with two dimensions ([6][2]), enable/disable status collection of limits in accordance with STAIR_RULE_LIMITS, set in Stair Default Settings/Rules and Standards/Treads and Risers panel

2D	✓	3D	✗	UI	✓	Parameter	✓	Property	✗	Default	[0]
----	---	----	---	----	---	-----------	---	----------	---	---------	-----

Value indexes are parallel to STAIR_RULE_LIMITS. Possible values:

- 0 - limit option of the same index in STAIR_RULE_LIMITS is currently not used
- 1 - limit option of the same index in STAIR_RULE_LIMITS is currently in use

General tread variables - available for listing and labels

Compatibility: introduced in ARCHICAD 21.

TREAD_STEP_INDEX

step index of the selected (current) tread

2D	✓	3D	✗	UI	✓	Parameter	✓	Property	✗	Default	0
----	---	----	---	----	---	-----------	---	----------	---	---------	---

TREAD_GOING

going length of the selected (current) tread

2D	✓	3D	✗	UI	✓	Parameter	✓	Property	✗	Default	0
----	---	----	---	----	---	-----------	---	----------	---	---------	---

TREAD_ELEVATION

elevation to Project Zero of the selected (current) tread

2D	✓	3D	✗	UI	✓	Parameter	✓	Property	✗	Default	0
----	---	----	---	----	---	-----------	---	----------	---	---------	---

TREAD_AREA		projected 2D area of the selected (current) tread									
2D	✓	3D	✗	UI	✓	Parameter	✓	Property	✗	Default	0
TREAD_FRONT_AREA		front surface area of the selected (current) tread									
2D	✓	3D	✗	UI	✓	Parameter	✓	Property	✗	Default	0
TREAD_VOLUME		volume of the selected (current) tread									
2D	✓	3D	✗	UI	✓	Parameter	✓	Property	✗	Default	0
TREAD_BMATs		array with one dimension ([n]), building materials of the selected (current) tread (n = number of building materials)									
2D	✓	3D	✗	UI	✓	Parameter	✓	Property	✗	Default	0

General riser variables - available for listing and labels

Compatibility: introduced in ARCHICAD 21.

RISER_STEP_INDEX		step index of the selected (current) riser									
2D	✓	3D	✗	UI	✓	Parameter	✓	Property	✗	Default	0
RISER_WIDTH		polyline length of the selected (current) riser									
2D	✓	3D	✗	UI	✓	Parameter	✓	Property	✗	Default	0
RISER_FRONT_AREA		front surface area of the selected (current) riser									
2D	✓	3D	✗	UI	✓	Parameter	✓	Property	✗	Default	0
RISER_VOLUME		volume of the selected (current) riser									
2D	✓	3D	✗	UI	✓	Parameter	✓	Property	✗	Default	0
RISER_BMATs		array with one dimension ([n]), building materials of the selected (current) riser (n = number of building materials)									
2D	✓	3D	✗	UI	✓	Parameter	✓	Property	✗	Default	0

Stair structure variables - available for listing and labels

Compatibility: introduced in ARCHICAD 21.

STRUCTURE_WIDTH		width of the selected (current) structure component									
2D	✓	3D	✗	UI	✓	Parameter	✓	Property	✗	Default	0
STRUCTURE_HEIGHT		height of the selected (current) structure component (difference of min. and max. z)									
2D	✓	3D	✗	UI	✓	Parameter	✓	Property	✗	Default	0
STRUCTURE_3DLENGTH		full 3D length of the selected (current) structure component									
2D	✓	3D	✗	UI	✓	Parameter	✓	Property	✗	Default	0
STRUCTURE_VOLUME		volume of the selected (current) structure component									
2D	✓	3D	✗	UI	✓	Parameter	✓	Property	✗	Default	0
STRUCTURE_THICKNESS		thickness of the selected (current) structure component									
2D	✓	3D	✗	UI	✓	Parameter	✓	Property	✗	Default	0

Stair Model View Options variables

Related settings are available on the Model View Options/Stair and Railing options dialog.

Compatibility: introduced in ARCHICAD 21.

GLOB_MVO_STAIR_FLOOR_PLAN_OPT		Stair MVO Floor Plan option: 0 - Floor Plan, 1 - Reflected Ceiling Plan									
2D	✓	3D	✗	UI	✓	Parameter	✗	Property	✗	Default	1

GLOB_MVO_STAIR_FLOOR_PLAN_COMP Stair MVO Component bitset

2D	✓	3D	✗	UI	✓	Parameter	✗	Property	✗	Default	1
----	---	----	---	----	---	-----------	---	----------	---	---------	---

mask: returns information about the visible stair components of the floor plan

$mask = j_1 + 2*j_2 + 4*j_3 + 8*j_4 + 16*j_5 + 32*j_6 + 64*j_7 + 128*j_8 + 256*j_9$, where each j can be 0 or 1.

j_1 : walking line

j_2 : numbering

j_3 : up/down text

j_4 : description

j_5 : tread accessories

j_6 : structure - beam

j_7 : structure - stringers

j_8 : structure - cantilevered

j_9 : structure - monolithic Compatibility: introduced in ARCHICAD 22.

GLOB_MVO_RAILING_PLAN_COMP Railing MVO Component bitset

2D	✓	3D	✗	UI	✓	Parameter	✗	Property	✗	Default	127
----	---	----	---	----	---	-----------	---	----------	---	---------	-----

mask: returns information about the visible stair components of the floor plan

$mask = j_1 + 2*j_2 + 4*j_3 + 8*j_4 + 16*j_5 + 32*j_6 + 64*j_7$, where each j can be 0 or 1.

j_1 : posts

j_2 : top rail

j_3 : handrails

j_4 : rails

j_5 : inner posts

j_6 : balusters

j_7 : panels

Stair 2D variables - available for floor plan representation only

Compatibility: introduced in ARCHICAD 21.

Stair grid variables

STAIR2D_FULL_TPOLYGON_GEOM											
array with two dimensions ([n][3]), data triplets of tread polygon nodes											
2D	✔	3D	✘	UI	✘	Parameter	✘	Property	✘	Default	[0]
<i>n</i> = number of treads * 5 nodes for each tread (in general): <ul style="list-style-type: none"> • [n][1] - coordinate x of polygon node measured from stair origin • [n][2] - coordinate y of polygon node measured from stair origin • [n][3] - central angle of edge starting from the node (0 - straight, > 0 - curved counter-clockwise, < 0 - curved clockwise) 											
STAIR2D_FULL_TPOLYGON_FLAGS											
array with two dimensions ([n][4]), additional data of the tread polygons, in accordance with STAIR2D_FULL_TPOLYGON_GEOM											
2D	✔	3D	✘	UI	✘	Parameter	✘	Property	✘	Default	[0]
<i>n</i> = number of treads * 5 nodes for each tread (in general): <ul style="list-style-type: none"> • [n][1] - index of tread • [n][2] - edge type starting from node (0 - leading, 1 - trailing, 2 - left, 3 - right, 4 - breakline, -1 - closing) • [n][3] - visibility of the edge starting from the node (1 - visible, 0 - omitted) • [n][4] - type of tread (0 - flight, 1 - landing) 											
STAIR2D_FULL_RPOLYLINE_GEOM											
array with two dimensions ([n][3]), data triplets of riser polyline nodes											
2D	✔	3D	✘	UI	✘	Parameter	✘	Property	✘	Default	[0]
<i>n</i> = number of risers * 2 nodes for each tread (in general): <ul style="list-style-type: none"> • [n][1] - coordinate x of polyline node measured from stair origin • [n][2] - coordinate y of polyline node measured from stair origin • [n][3] - central angle of edge starting from the node (0 - straight, > 0 - curved counter-clockwise, < 0 - curved clockwise) 											
STAIR2D_FULL_RPOLYLINE_FLAGS											
array with two dimensions ([n][1]), additional data of the riser polylines, in accordance with STAIR2D_FULL_RPOLYLINE_GEOM											
2D	✔	3D	✘	UI	✘	Parameter	✘	Property	✘	Default	[0]
<i>n</i> = number of risers * 2 nodes for each tread (in general): <ul style="list-style-type: none"> • [n][1] - index of riser 											

STAIR2D_FULL_BOUNDARY_GEOM array with two dimensions ($[n][3]$), data triplets of stair boundary polygon nodes

2D	✓	3D	✗	UI	✗	Parameter	✗	Property	✗	Default	[0]
----	---	----	---	----	---	-----------	---	----------	---	---------	-----

n = number of boundary nodes (5 in general):

- $[n][1]$ - coordinate x of polygon node measured from stair origin
- $[n][2]$ - coordinate y of polygon node measured from stair origin
- $[n][3]$ - central angle of edge starting from the node (0 - straight, > 0 - curved counter-clockwise, < 0 - curved clockwise)

The following globals are used to define the parts of the stair represented below the first breakmark.

STAIR2D_LOWER_TPOLYGON_GEOM array with two dimensions ($[n][3]$), data triplets of tread polygon nodes of lower part, similar to STAIR2D_FULL_TPOLYGON_GEOM

2D	✓	3D	✗	UI	✗	Parameter	✗	Property	✗	Default	[0]
----	---	----	---	----	---	-----------	---	----------	---	---------	-----

STAIR2D_LOWER_TPOLYGON_FLAGS array with two dimensions ($[n][4]$), additional data of tread polygon nodes of lower part, similar to STAIR2D_FULL_TPOLYGON_FLAGS

2D	✓	3D	✗	UI	✗	Parameter	✗	Property	✗	Default	[0]
----	---	----	---	----	---	-----------	---	----------	---	---------	-----

STAIR2D_LOWER_RPOLYLINE_GEOM array with two dimensions ($[n][3]$), data triplets of riser polyline nodes of lower part, similar to STAIR2D_FULL_RPOLYLINE_GEOM

2D	✓	3D	✗	UI	✗	Parameter	✗	Property	✗	Default	[0]
----	---	----	---	----	---	-----------	---	----------	---	---------	-----

STAIR2D_LOWER_RPOLYLINE_FLAGS array with two dimensions ($[n][1]$), additional data of riser polyline nodes of lower part, similar to STAIR2D_FULL_RPOLYLINE_FLAGS

2D	✓	3D	✗	UI	✗	Parameter	✗	Property	✗	Default	[0]
----	---	----	---	----	---	-----------	---	----------	---	---------	-----

STAIR2D_LOWER_BOUNDARY_GEOM array with two dimensions ($[n][3]$), data triplets of stair boundary polygon nodes of lower part, similar to STAIR2D_FULL_BOUNDARY_GEOM

2D	✓	3D	✗	UI	✗	Parameter	✗	Property	✗	Default	[0]
----	---	----	---	----	---	-----------	---	----------	---	---------	-----

The following globals are used to define the parts of the stair represented between two breakmarks.

STAIR2D_MIDDLE_TPOLYGON_GEOM array with two dimensions ($[n][3]$), data triplets of tread polygon nodes of middle part, similar to STAIR2D_FULL_TPOLYGON_GEOM

2D	✓	3D	✗	UI	✗	Parameter	✗	Property	✗	Default	[0]
----	---	----	---	----	---	-----------	---	----------	---	---------	-----

STAIR2D_MIDDLE_TPOLYGON_FLAGS array with two dimensions ([n][4]), additional data of tread polygon nodes of middle part, similar to STAIR2D_FULL_TPOLYGON_FLAGS

2D	✓	3D	✗	UI	✗	Parameter	✗	Property	✗	Default	[0]
----	---	----	---	----	---	-----------	---	----------	---	---------	-----

STAIR2D_MIDDLE_RPOLYLINE_GEOM array with two dimensions ([n][3]), data triplets of riser polyline nodes of middle part, similar to STAIR2D_FULL_RPOLYLINE_GEOM

2D	✓	3D	✗	UI	✗	Parameter	✗	Property	✗	Default	[0]
----	---	----	---	----	---	-----------	---	----------	---	---------	-----

STAIR2D_MIDDLE_RPOLYLINE_FLAGS array with two dimensions ([n][1]), additional data of riser polyline nodes of middle part, similar to STAIR2D_FULL_RPOLYLINE_FLAGS

2D	✓	3D	✗	UI	✗	Parameter	✗	Property	✗	Default	[0]
----	---	----	---	----	---	-----------	---	----------	---	---------	-----

STAIR2D_MIDDLE_BOUNDARY_GEOM array with two dimensions ([n][3]), data triplets of stair boundary polygon nodes of middle part, similar to STAIR2D_FULL_BOUNDARY_GEOM

2D	✓	3D	✗	UI	✗	Parameter	✗	Property	✗	Default	[0]
----	---	----	---	----	---	-----------	---	----------	---	---------	-----

The following globals are used to define the parts of the stair represented above the last breakmark.

STAIR2D_UPPER_TPOLYGON_GEOM array with two dimensions ([n][3]), data triplets of tread polygon nodes of upper part, similar to STAIR2D_FULL_TPOLYGON_GEOM

2D	✓	3D	✗	UI	✗	Parameter	✗	Property	✗	Default	[0]
----	---	----	---	----	---	-----------	---	----------	---	---------	-----

STAIR2D_UPPER_TPOLYGON_FLAGS array with two dimensions ([n][4]), additional data of tread polygon nodes of upper part, similar to STAIR2D_FULL_TPOLYGON_FLAGS

2D	✓	3D	✗	UI	✗	Parameter	✗	Property	✗	Default	[0]
----	---	----	---	----	---	-----------	---	----------	---	---------	-----

STAIR2D_UPPER_RPOLYLINE_GEOM array with two dimensions ([n][3]), data triplets of riser polyline nodes of upper part, similar to STAIR2D_FULL_RPOLYLINE_GEOM

2D	✓	3D	✗	UI	✗	Parameter	✗	Property	✗	Default	[0]
----	---	----	---	----	---	-----------	---	----------	---	---------	-----

STAIR2D_UPPER_RPOLYLINE_FLAGS array with two dimensions ([n][1]), additional data of riser polyline nodes of upper part, similar to STAIR2D_FULL_RPOLYLINE_FLAGS

2D	✓	3D	✗	UI	✗	Parameter	✗	Property	✗	Default	[0]
----	---	----	---	----	---	-----------	---	----------	---	---------	-----

STAIR2D_UPPER_BOUNDARY_GEOM array with two dimensions ($[n][3]$), data triplets of stair boundary polygon nodes of upper part, similar to STAIR2D_FULL_BOUNDARY_GEOM

2D	✔	3D	✘	UI	✘	Parameter	✘	Property	✘	Default	[0]
----	---	----	---	----	---	-----------	---	----------	---	---------	-----

Stair walking line symbol variables

STAIR2D_FULL_WALKLINE_GEOM array with two dimensions ($[n][3]$), data triplets of stair walking line nodes, full length

2D	✔	3D	✘	UI	✘	Parameter	✘	Property	✘	Default	[0]
----	---	----	---	----	---	-----------	---	----------	---	---------	-----

n = number of polyline nodes for the full length of the walking line

- $[n][1]$ - coordinate x of polyline node measured from stair origin
- $[n][2]$ - coordinate y of polyline node measured from stair origin
- $[n][3]$ - central angle of edge starting from the node (0 - straight, > 0 - curved counter-clockwise, < 0 - curved clockwise)

STAIR2D_FULL_WALKLINE_FLAGS array with two dimensions ($[n][2]$), additional data of stair walking line nodes, full length

2D	✔	3D	✘	UI	✘	Parameter	✘	Property	✘	Default	[0]
----	---	----	---	----	---	-----------	---	----------	---	---------	-----

n = number of polyline nodes for the full length of the walking line

mask: returns information about the node position

$mask = j_1 + 2*j_2 + 4*j_3 + 8*j_4$, where each j can be 0 or 1.

j_1 : node is on trail end of first tread

j_2 : node is on lead end of landing

j_3 : node is on trail end of landing

j_4 : node is on lead end of last tread

- $[n][1]$ - location mask of the node
- $[n][2]$ - index of tread where the node is on trail end or above

STAIR2D_LOWER_WALKLINE_GEOM array with two dimensions ($[n][3]$), data triplets of stair walking line nodes, lower part (same logic as stair polygon slicing)

2D	✔	3D	✘	UI	✘	Parameter	✘	Property	✘	Default	[0]
----	---	----	---	----	---	-----------	---	----------	---	---------	-----

n = number of polyline nodes for the lower part of the walking line

- $[n][1]$ - coordinate x of polyline node measured from stair origin
 - $[n][2]$ - coordinate y of polyline node measured from stair origin
 - $[n][3]$ - central angle of edge starting from the node (0 - straight, > 0 - curved counter-clockwise, < 0 - curved clockwise)
-

STAIR2D_LOWER_WALKLINE_FLAGS integer array with two dimensions ($[n][2]$), additional data of stair walking line nodes, lower part

2D	✔	3D	✘	UI	✘	Parameter	✘	Property	✘	Default	[0]
----	---	----	---	----	---	-----------	---	----------	---	---------	-----

n = number of polyline nodes for the lower part of the walking line

mask: returns information about the node position

$mask = j_1 + 2*j_2 + 4*j_3 + 8*j_4$, where each j can be 0 or 1.

j_1 : node is on trail end of first tread

j_2 : node is on lead end of landing

j_3 : node is on trail end of landing

j_4 : node is on lead end of last tread

- $[n][1]$ - location mask of the node
- $[n][2]$ - index of tread where the node is on trail end or above

STAIR2D_MIDDLE_WALKLINE_GEOM array with two dimensions ($[n][3]$), data triplets of stair walking line nodes, middle part

2D	✔	3D	✘	UI	✘	Parameter	✘	Property	✘	Default	[0]
----	---	----	---	----	---	-----------	---	----------	---	---------	-----

n = number of polyline nodes for the middle part of the walking line

- $[n][1]$ - coordinate x of polyline node measured from stair origin
- $[n][2]$ - coordinate y of polyline node measured from stair origin
- $[n][3]$ - central angle of edge starting from the node (0 - straight, > 0 - curved counter-clockwise, < 0 - curved clockwise)

STAIR2D_MIDDLE_WALKLINE_FLAGS integer array with two dimensions ($[n][2]$), additional data of stair walking line nodes, middle part

2D	✔	3D	✘	UI	✘	Parameter	✘	Property	✘	Default	[0]
----	---	----	---	----	---	-----------	---	----------	---	---------	-----

n = number of polyline nodes for the middle part of the walking line

mask: returns information about the node position

$mask = j_1 + 2*j_2 + 4*j_3 + 8*j_4$, where each j can be 0 or 1.

j_1 : node is on trail end of first tread

j_2 : node is on lead end of landing

j_3 : node is on trail end of landing

j_4 : node is on lead end of last tread

- $[n][1]$ - location mask of the node
 - $[n][2]$ - index of tread where the node is on trail end or above
-

STAIR2D_UPPER_WALKLINE_GEOM array with two dimensions ($[n][3]$), data triplets of stair walking line nodes, upper part

2D	✔	3D	✘	UI	✘	Parameter	✘	Property	✘	Default	[0]
----	---	----	---	----	---	-----------	---	----------	---	---------	-----

n = number of polyline nodes for the upper part of the walking line

- $[n][1]$ - coordinate x of polyline node measured from stair origin
- $[n][2]$ - coordinate y of polyline node measured from stair origin
- $[n][3]$ - central angle of edge starting from the node (0 - straight, > 0 - curved counter-clockwise, < 0 - curved clockwise)

STAIR2D_UPPER_WALKLINE_FLAGS array with two dimensions ($[n][2]$), additional data of stair walking line nodes, upper part

2D	✔	3D	✘	UI	✘	Parameter	✘	Property	✘	Default	[0]
----	---	----	---	----	---	-----------	---	----------	---	---------	-----

n = number of polyline nodes for the upper part of the walking line

mask: returns information about the node position

$mask = j_1 + 2*j_2 + 4*j_3 + 8*j_4$, where each j can be 0 or 1.

j_1 : node is on trail end of first tread

j_2 : node is on lead end of landing

j_3 : node is on trail end of landing

j_4 : node is on lead end of last tread

- $[n][1]$ - location mask of the node
- $[n][2]$ - index of tread where the node is on trail end or above

Stair break mark symbol variables

STAIR2D_BREAKMARK_GEOM array with two dimensions ($[n][9]$), data of breakmark polyline nodes

2D	✔	3D	✘	UI	✘	Parameter	✘	Property	✘	Default	[0]
----	---	----	---	----	---	-----------	---	----------	---	---------	-----

n = number of breakmarks * 9 nodes-data for each breakmark (maximum number of displayed breakmarks is 4):

- $[n][1]$ - coordinate x of polyline start measured from stair origin
 - $[n][2]$ - coordinate y of polyline start measured from stair origin
 - $[n][3]$ - coordinate x of polyline end measured from stair origin
 - $[n][4]$ - coordinate y of polyline end measured from stair origin
 - $[n][5]$ - break mark angle calculated from the perpendicular of the walking line, in degrees (value updates with editing). See also `STAIR2D_BREAKMARK_ANGLE`.
 - $[n][6]$ - coordinate x of start extension measured from stair origin Compatibility: introduced in ARCHICAD 22.
 - $[n][7]$ - coordinate y of start extension measured from stair origin Compatibility: introduced in ARCHICAD 22.
 - $[n][8]$ - coordinate x of end extension measured from stair origin Compatibility: introduced in ARCHICAD 22.
 - $[n][9]$ - coordinate y of end extension measured from stair origin Compatibility: introduced in ARCHICAD 22.
-

STAIR2D_BREAKMARK_FLAGS		integer array with two dimensions ([n][1]), additional data for breakmark polyline visibility									
2D	✔	3D	✖	UI	✖	Parameter	✖	Property	✖	Default	[0]

n = number of breakmarks visible in the current settings (maximum 4)

Attribute Set Index:

- 1: break mark visible,
- 2: break mark hidden

STAIR2D_BREAKMARK_ANGLE		break mark angle in degrees (Real type value) as set in the Stair Settings dialog. Keeps the preset value even if the break mark is edited.									
2D	✔	3D	✖	UI	✖	Parameter	✖	Property	✖	Default	0

Rise and Run description variables

STAIR2D_DESCRIPTION_POSITION		array with two dimensions ([n][4]), containing information about the position and direction of the Description text									
2D	✔	3D	✖	UI	✖	Parameter	✖	Property	✖	Default	[0]

n: position definition:

- 1: center of first flight,
 - 2: center of first landing,
 - 3: center of last flight,
 - 4: center of last landing,
 - 5: center of stair.
- [n][1] - coordinate x of description position measured from stair origin
 - [n][2] - coordinate y of description position measured from stair origin
 - [n][3] - walking line normal vector x coordinate in description position
 - [n][4] - walking line normal vector y coordinate in description position

Stair draining 2D variables

No slicing with breakmarks is present in the geometry of the following globals.

STAIR2D_EXT_TPOLYGON_GEOM

array with two dimensions ([n][3]), data triplets of extended tread polygon nodes (including draining). Similar structure as STAIR2D_FULL_TPOLYGON_GEOM.

2D	✔	3D	✘	UI	✘	Parameter	✘	Property	✘	Default	[0]
----	---	----	---	----	---	-----------	---	----------	---	---------	-----

n = number of treads * 5 nodes for each tread (in general):

- [n][1] - coordinate x of extended tread polygon node measured from stair origin
- [n][2] - coordinate y of extended tread polygon node measured from stair origin
- [n][3] - central angle of edge starting from the node (0 - straight, > 0 - curved counter-clockwise, < 0 - curved clockwise)

STAIR2D_EXT_TPOLYGON_FLAGS

array with two dimensions ([n][4]), additional data of the tread extended polygons, in accordance with STAIR2D_EXT_TPOLYGON_GEOM. Similar structure as STAIR2D_FULL_TPOLYGON_FLAGS.

2D	✔	3D	✘	UI	✘	Parameter	✘	Property	✘	Default	[0]
----	---	----	---	----	---	-----------	---	----------	---	---------	-----

n = number of treads * 5 nodes for each tread (in general):

- [n][1] - index of tread
- [n][2] - edge type starting from node (0 - leading, 1 - trailing, 2 - left, 3 - right, -1 - closing)
- [n][3] - visibility of the edge starting from the node (1 - visible, 0 - omitted)
- [n][4] - type of tread (0 - flight, 1 - landing)

STAIR2D_EXT_RPOLYLINE_GEOM

array with two dimensions ([n][3]), data triplets of extended riser polyline nodes (including draining). Similar structure as STAIR2D_FULL_RPOLYLINE_GEOM.

2D	✔	3D	✘	UI	✘	Parameter	✘	Property	✘	Default	[0]
----	---	----	---	----	---	-----------	---	----------	---	---------	-----

n = number of risers * 2 nodes for each tread (in general):

- [n][1] - coordinate x of polyline node measured from stair origin
- [n][2] - coordinate y of polyline node measured from stair origin
- [n][3] - central angle of edge starting from the node (0 - straight, > 0 - curved counter-clockwise, < 0 - curved clockwise)

STAIR2D_EXT_RPOLYLINE_FLAGS

array with two dimensions ([n][1]), additional data of the riser polylines, in accordance with STAIR2D_EXT_RPOLYLINE_GEOM. Similar structure as STAIR2D_FULL_RPOLYLINE_FLAGS.

2D	✔	3D	✘	UI	✘	Parameter	✘	Property	✘	Default	[0]
----	---	----	---	----	---	-----------	---	----------	---	---------	-----

n = number of risers * 2 nodes for each tread (in general):

- [n][1] - index of riser

STAIR2D_DRAIN_TPOLYGON_GEOM array with two dimensions ([n][3]), data triplets of drain polygon nodes. Similar structure as STAIR2D_FULL_TPOLYGON_GEOM.

2D	✔	3D	✘	UI	✘	Parameter	✘	Property	✘	Default	[0]
----	---	----	---	----	---	-----------	---	----------	---	---------	-----

$n = \text{number of treads} * 5 \text{ nodes for each tread (in general):}$

- [n][1] - coordinate x of extended tread polygon node measured from stair origin
- [n][2] - coordinate y of extended tread polygon node measured from stair origin
- [n][3] - central angle of edge starting from the node (0 - straight, > 0 - curved counter-clockwise, < 0 - curved clockwise)

STAIR2D_DRAIN_TPOLYGON_FLAGS array with two dimensions ([n][4]), additional data of the drain polygons, in accordance with STAIR2D_DRAIN_TPOLYGON_GEOM. Similar structure as STAIR2D_FULL_TPOLYGON_FLAGS.

2D	✔	3D	✘	UI	✘	Parameter	✘	Property	✘	Default	[0]
----	---	----	---	----	---	-----------	---	----------	---	---------	-----

$n = \text{number of treads} * 5 \text{ nodes for each tread (in general):}$

- [n][1] - index of tread
- [n][2] - edge type starting from node
 - 0 - leading
 - 1 - trailing
 - 2 - left (+100 - draining side left, +200 - draining side left and "Stepped" type)
 - 3 - right (+100 - draining side right, +200 - draining side right and "Stepped" type)
 - -1 - closing
- [n][3] - visibility of the edge starting from the node (1 - visible, 0 - omitted)
- [n][4] - type of tread (0 - flight, 1 - landing)

Stair structure 2D variables - Beam Structures

STAIR2D_POLYLINES_GEOM array with two dimensions ([n][3]), where n is the number of structure polyline nodes of the current flight/landing in 2D, contains geometric data of the polyline nodes derived from the stair boundary: left boundary line, right boundary line and centerline.

2D	✔	3D	✔	UI	✘	Parameter	✘	Property	✘	Default	[0]
----	---	----	---	----	---	-----------	---	----------	---	---------	-----

- [n][1] - coordinate x of structure polyline node measured from stair origin
- [n][2] - coordinate y of structure polyline node measured from stair origin
- [n][3] - central angle of edge starting from the node (0 - straight, > 0 - curved counter-clockwise, < 0 - curved clockwise)

STAIR2D_POLYLINES_FLAGS

array with two dimensions ([n][1]), where n is the number of structure polyline nodes of the current flight/landing in 2D, contains group data of the polyline nodes.

2D	✔	3D	✔	UI	✘	Parameter	✘	Property	✘	Default	[0]
----	---	----	---	----	---	-----------	---	----------	---	---------	-----

- [n][1] - position flags, point n belongs to: 0 - left boundary, 1 - right boundary, 2 - center line

STAIR2D_STRUCT_ATTRIBUTES

array with two dimensions ([2][7]), containing attributes settings of the visible ([1][n]) and invisible ([2][n]) parts of the structure.

2D	✔	3D	✘	UI	✘	Parameter	✘	Property	✘	Default	[0, 0, 0, 0, 0, 0, 0]
----	---	----	---	----	---	-----------	---	----------	---	---------	-----------------------

- [n][1] - boundary line type index
- [n][2] - boundary pen index
- [n][3] - symbol fill type
- [n][4] - symbol fill pen
- [n][5] - symbol fill background pen
- [n][6] - symbol fill ON/OFF boolean control for Custom display only (STAIR2D_CUSTOMDISPLAY = 1)
- [n][7] - symbol part enable ON/OFF boolean control for Custom display only (STAIR2D_CUSTOMDISPLAY = 1).

Stair structure 2D variables - Monolithic Structure

Compatibility: introduced in ARCHICAD 22.

These globals are filled with values with respect to actual Floor Plan/Reflected Ceiling Plan View.

STAIR2D_FULL_SPOLYGON_GEOM

array with two dimensions ([n][3]), containing sub-polygons of the stair 2D projection.

2D	✔	3D	✘	UI	✘	Parameter	✘	Property	✘	Default	[0]
----	---	----	---	----	---	-----------	---	----------	---	---------	-----

- [n][1] - coordinate x of structure polygon node measured from stair origin
- [n][2] - coordinate y of structure polygon node measured from stair origin
- [n][3] - central angle of edge starting from the node (0 - straight, > 0 - curved counter-clockwise, < 0 - curved clockwise)

STAIR2D_FULL_SPOLYGON_FLAGSarray with two dimensions ($[n][2]$), where n is the number of polygon nodes.

2D	✔	3D	✖	UI	✖	Parameter	✖	Property	✖	Default	[0]
----	---	----	---	----	---	-----------	---	----------	---	---------	-----

- $[n][1]$ - index of sub-polygon
- $[n][2]$ - type of sub-polygon
 - 1: Flight boundary - without connection
 - 2: Flight boundary - with connection
 - 3: Landing boundary - without connection
 - 4: Landing boundary - with connection
 - 5: Connection
 - 6: Draining
- $[n][3]$ - type of sub-polygon edge
 - -1: closing point (next point is new sub-polygon)
 - 0: invisible edge (only bounds area)
 - 1: visible monolith edge (visible or hidden attribute set by *STAIR2D_VISIBILITY*)
 - 2: visible connection edge (visible or hidden attribute set by *STAIR2D_VISIBILITY*)
 - 3: visible connection detail edge (visible or hidden attribute set by *STAIR2D_VISIBILITY*)

A sub-polygon of type Connection can have mixed monolith and connection edges.

STAIR2D_FULL_SPOLYLINE_GEOMarray with two dimensions ($[n][2]$), containing edges within the boundary.

2D	✔	3D	✖	UI	✖	Parameter	✖	Property	✖	Default	[0]
----	---	----	---	----	---	-----------	---	----------	---	---------	-----

- $[2*i][1]$ - coordinate x of starting node measured from stair origin
- $[2*i][2]$ - coordinate y of starting node measured from stair origin
- $[2*i + 1][1]$ - coordinate x of end node measured from stair origin
- $[2*i + 1][2]$ - coordinate y of end node measured from stair origin

STAIR2D_FULL_SPOLYLINE_FLAGS

array with one dimension [n], where n is the number of nodes in STAIR2D_FULL_SPOLYLINE_GEOM.

2D	✓	3D	✗	UI	✗	Parameter	✗	Property	✗	Default	[0]
----	---	----	---	----	---	-----------	---	----------	---	---------	-----

- [n] - type of edge
 - 1: Going, cut with drain
 - 2: Going, full
 - 3: Going Nosing (slanted risers), cut with drain
 - 4: Going Nosing (slanted risers), full
 - 5: Landing Line, cut with drain
 - 6: Landing Line, full
 - 7: Connection
 - 8: Connection Detail
 - 9: Draining (stepped draining)
 - 10: Draining Nosing (draining with slanted steps)

STAIR2D_MONOLITH_ATTRIBUTES

array with two dimensions ([2][23]), containing attributes and visibility settings of the visible ([1][n]) and invisible ([2][n]) parts of the monolithic structure.

2D	✔	3D	✖	UI	✖	Parameter	✖	Property	✖	Default	[0]
----	---	----	---	----	---	-----------	---	----------	---	---------	-----

- [n][1] - Structure visibility (bool)
- [n][2] - Draining visibility (bool)
- [n][3] - Contour line type
- [n][4] - Contour line pen
- [n][5] - Structure Going visibility (bool)
- [n][6] - Landing Line visibility (bool)
- [n][7] - Going Line Type
- [n][8] - Going Line Pen
- [n][9] - Structure Going Nosing visibility (bool)
- [n][10] - Going Nosing line type
- [n][11] - Going Nosing line pen
- [n][12] - Connection visibility (bool)
- [n][13] - Connection line type
- [n][14] - Connection line pen
- [n][15] - Connection Detail line type
- [n][16] - Connection Detail line pen
- [n][17] - Draining Fill and Structure Fill visibility (bool)
- [n][18] - Structure fill type
- [n][19] - Structure fill pen
- [n][20] - Structure fill background pen
- [n][21] - Draining fill type
- [n][22] - Draining fill pen
- [n][23] - Draining fill background pen

General 2D related variables

STAIR2D_CURRSTORY_LOCATION

information about the current story visibility of the stair

2D		3D		UI		Parameter		Property		Default	0
----	---	----	---	----	---	-----------	---	----------	---	---------	---

values:

- 1 : *below relevant story,*
- 2 : *first relevant story,*
- 3 : *inter-relevant story,*
- 4 : *top-last relevant story,*
- 5 : *above relevant story.*

STAIR2D_LAYOUT_TYPES[5]

array with one dimension ([5]), information about the display layout types of the stair according to STAIR2D_CURRSTORY_LOCATION

2D	✔	3D	✖	UI	✔	Parameter	✔	Property	✖	Default	[0]
----	---	----	---	----	---	-----------	---	----------	---	---------	-----

- [1] - below relevant story layout setting
- [2] - first relevant story layout setting
- [3] - inter-relevant story layout setting
- [4] - top-last relevant story layout setting
- [5] - above relevant story layout setting

Layout setting values:

- 0: invalid
- 1: With Break Mark: Visible - Hidden
- 2: No Break Mark: Visible
- 3: Below Break Mark: Visible
- 4: Above Break Mark: Visible
- 7: No Break Mark: Hidden
- 8: Above Break Mark: Hidden
- 9: Below Break Mark: Hidden
- 13: With Break Mark: All Visible
- 14: With Break Mark: Hidden - Visible
- 5: Multistory 2D: Visible Inbetween Break Marks
- 6: Multistory 2D: Hidden - Visible - Hidden
- 10: Multistory 2D: All Visible
- 11: Multistory 2D: Hidden - Visible - None
- 12: Multistory 2D: None - Visible - Hidden

STAIR2D_VISIBILITY

type of the active attribute set of the current drawing

2D	✔	3D	✖	UI	✔	Parameter	✔	Property	✖	Default	0
----	---	----	---	----	---	-----------	---	----------	---	---------	---

Usable in connection with Grid and Tread 2D symbol only.

values:

- 1: 'Visible' attribute set is in effect
- 0: 'Hidden' attribute set is in effect

STAIR2D_CUSTOMDISPLAY

contains information about the model view settings of the stair

2D	✓	3D	✗	UI	✓	Parameter	✓	Property	✗	Default	0
----	---	----	---	----	---	-----------	---	----------	---	---------	---

values:

0: stair is displayed according to Model View Option settings

1: stair is displayed with custom settings

STAIR_START_WITH_RISER

Boolean telling whether the stair starts with a riser.

2D	✓	3D	✗	UI	✗	Parameter	✗	Property	✗	Default	0
----	---	----	---	----	---	-----------	---	----------	---	---------	---

*Compatibility: introduced in ARCHICAD 22.***STAIR_END_WITH_RISER**

Boolean telling whether the stair ends with a riser.

2D	✓	3D	✗	UI	✗	Parameter	✗	Property	✗	Default	0
----	---	----	---	----	---	-----------	---	----------	---	---------	---

*Compatibility: introduced in ARCHICAD 22.***STAIR_TREAD_EXIST**

Boolean array ([2]) telling whether the stair has a Tread component.

2D	✓	3D	✗	UI	✓	Parameter	✓	Property	✗	Default	0
----	---	----	---	----	---	-----------	---	----------	---	---------	---

*Compatibility: introduced in ARCHICAD 22.**Treads customized in Edit mode don't have effect on these values.*

- [1] - on Flight
- [2] - on Landing

STAIR_RISER_EXIST

Boolean array ([2]) telling whether the stair has a Riser component.

2D	✓	3D	✗	UI	✓	Parameter	✓	Property	✗	Default	0
----	---	----	---	----	---	-----------	---	----------	---	---------	---

*Compatibility: introduced in ARCHICAD 22.**Risers customized in Edit mode don't have effect on these values.*

- [1] - on Flight
- [2] - on Landing

STAIR_NOSING_EXIST		Boolean array ([2]) telling whether the stair has a Tread nosing (length > 0) set.									
2D	✔	3D	✘	UI	✔	Parameter	✔	Property	✘	Default	0

Compatibility: introduced in ARCHICAD 22.

Treads customized in Edit mode don't have effect on these values.

- [1] - on Flight
- [2] - on Landing

Stair 3D variables - available for 3D representation (and connecting viewpoints) only

Compatibility: introduced in ARCHICAD 21.

Stair riser 3D variables

RISER_HEIGHT		3D height value of the selected riser									
2D	✘	3D	✔	UI	✘	Parameter	✘	Property	✘	Default	0

RISER_THICKNESS		3D thickness value of the selected riser									
2D	✘	3D	✔	UI	✘	Parameter	✘	Property	✘	Default	0

STAIR_RISER_GEOMETRY		array with two dimensions ([n][3]), data triplets of stair riser polyline path nodes									
2D	✘	3D	✔	UI	✘	Parameter	✘	Property	✘	Default	[0]

n = number of nodes of the riser polyline path:

- [n][1] - coordinate x of polyline node measured from stair origin
- [n][2] - coordinate y of polyline node measured from stair origin
- [n][3] - central angle of edge starting from the node (0 - straight, > 0 - curved counter-clockwise, < 0 - curved clockwise)

RISER_CUT array with two dimensions ([2][2]), contains data of starting and closing points of the ideal TUBE (modelling the riser in 3D)

2D	⊖	3D	✓	UI	⊖	Parameter	⊖	Property	⊖	Default	[0]
----	---	----	---	----	---	-----------	---	----------	---	---------	-----

The display segmentation of the tube does not affect the value of this variable. To achieve a correct model in all cases, this global can be used to calculate the actual starting and closing points of the tube following the segmented arc.

- [1][1] - coordinate x of starting node measured from stair origin
- [1][2] - coordinate y of starting node measured from stair origin
- [2][1] - coordinate x of closing node measured from stair origin
- [2][2] - coordinate y of closing node measured from stair origin

RISER_SLANT_ANGLE slant angle of the selected riser

2D	⊖	3D	✓	UI	⊖	Parameter	⊖	Property	⊖	Default	0
----	---	----	---	----	---	-----------	---	----------	---	---------	---

In case Slanting is set to 0, the value of this global is 90 degrees.

Stair tread 2D-3D variables

TREAD_THICKNESS 3D thickness value of the selected tread

2D	✓	3D	✓	UI	⊖	Parameter	⊖	Property	⊖	Default	0
----	---	----	---	----	---	-----------	---	----------	---	---------	---

STAIR_TREAD_GEOMETRY array with two dimensions ([n][3]), data triplets of stair tread polygon nodes

2D	✓	3D	✓	UI	⊖	Parameter	⊖	Property	⊖	Default	[0]
----	---	----	---	----	---	-----------	---	----------	---	---------	-----

n = number of nodes of the tread polygon:

- [n][1] - coordinate x of node measured from stair origin
 - [n][2] - coordinate y of node measured from stair origin
 - [n][3] - central angle of edge starting from the node (0 - straight, > 0 - curved counter-clockwise, < 0 - curved clockwise)
-

STAIR_TREAD_FLAGS array with two dimensions ($[n][1]$), additional data of the tread polygon edges (starting from nodes), in accordance with STAIR_TREAD_GEOMETRY

2D	✓	3D	✓	UI	✗	Parameter	✗	Property	✗	Default	[0]
----	---	----	---	----	---	-----------	---	----------	---	---------	-----

n = number of nodes of the tread polygon:

- $[n][1]$ - flag of the n th edge of the polygon

flags:

- 0: lead edge of tread polygon
- 1: trail edge of tread polygon
- 2: left edge of tread polygon
- 3: right edge of tread polygon
- 1: closing node of tread polygon

TREAD_LOWER_RISER_THICKNESS thickness of the riser below the current tread (measured between grid and structure)

2D	✓	3D	✓	UI	✗	Parameter	✗	Property	✗	Default	0
----	---	----	---	----	---	-----------	---	----------	---	---------	---

TREAD_LOWER_RISER_HEIGHT height of the riser below the current tread (measured between the bottom plane of the current tread and the upper plane of the previous tread)

2D	✓	3D	✓	UI	✗	Parameter	✗	Property	✗	Default	0
----	---	----	---	----	---	-----------	---	----------	---	---------	---

TREAD_LOWER_RISER_SLANT_ANGLE slant angle of the riser below the current tread in degrees (is Slanting = 0, the value is 90 degrees)

2D	✓	3D	✓	UI	✗	Parameter	✗	Property	✗	Default	0
----	---	----	---	----	---	-----------	---	----------	---	---------	---

TREAD_UPPER_RISER_THICKNESS thickness of the riser above the current tread (measured between grid and structure)

2D	✓	3D	✓	UI	✗	Parameter	✗	Property	✗	Default	0
----	---	----	---	----	---	-----------	---	----------	---	---------	---

TREAD_UPPER_RISER_HEIGHT height of the riser above the current tread (measured between the top plane of the current tread and the bottom plane of the following tread)

2D	✓	3D	✓	UI	✗	Parameter	✗	Property	✗	Default	0
----	---	----	---	----	---	-----------	---	----------	---	---------	---

TREAD_UPPER_RISER_SLANT_ANGLE slant angle of the riser above the current tread in degrees (is Slanting = 0, the value is 90 degrees)

2D	✓	3D	✓	UI	✗	Parameter	✗	Property	✗	Default	0
----	---	----	---	----	---	-----------	---	----------	---	---------	---

TREAD_NOSING_METHOD		information about the nosing method of the current tread, as set on the Stair Settings dialog									
2D	✓	3D	✓	UI	✓	Parameter	✓	Property	✗	Default	0

values:

- 1: *nosing by value length*
- 2: *nosing by slanting length*

TREAD_NOSING		contains tread nosing depth value of the selected tread (horizontal offset, as set on the Stair Settings dialog), in case TREAD_NOSING_METHOD = 1 (nosing by value length)									
2D	✓	3D	✓	UI	✓	Parameter	✓	Property	✗	Default	0

TREAD_NOSING_BY_SLANTING		contains tread nosing length value (vertical offset to control riser intersection point, as set on the Stair Settings dialog), in case TREAD_NOSING_METHOD = 2 (nosing by slanting length)									
2D	✓	3D	✓	UI	✓	Parameter	✓	Property	✗	Default	0

Stair structure variables

STAIR_STRUCTURE_GEOMETRY

array with two dimensions ([n][14]), where n is the number of structure polygons points of the current flight/landing.

2D	✓	3D	✓	UI	✓	Parameter	✗	Property	✗	Default	[0]
----	---	----	---	----	---	-----------	---	----------	---	---------	-----

- [n][1] - coordinate x of structure polygon node n , measured from stair origin
- [n][2] - coordinate y of structure polygon node n , measured from stair origin
- [n][3] - coordinate z of structure polygon node n , measured from stair origin
- [n][4] - central angle in degrees of the edge starting from node n (0 - straight edge, < 0 - arc, counter-clockwise, > 0 - arc, clockwise)
- [n][5] - riser slant angle of the edge starting from node n . In case of leading edge, the angle belongs to the riser below the polygon. In case of trailing edge, the angle belongs to the riser above the polygon. Contains 0 for all other edge categories.
- [n][6] - height of the riser below the structure polygon (returns 0 in case there is no riser, or if the polygon is a connection polygon)
- [n][7] - height of the riser above the structure polygon (returns 0 in case there is no riser, or if the polygon is a connection polygon)
- [n][8] - thickness of the tread of the structure polygon (returns 0 if the polygon is a connection polygon)
- [n][9] - thickness of the gap below the tread of the structure polygon (returns 0 if the polygon is a connection polygon)
- [n][10-14] - Compatibility: introduced in ARCHICAD 22.
- [n][10] - Cantilevered structure height (read from its `ac_stairStructureThickness` parameter) beneath the tread at this point. Zero in case of connection polygons.
- [n][11] - Tread nosing at the edge starting from this point.
 - Zero in case of connection polygons
 - Nosing of the tread above leading edges
 - Nosing of the next tread above trailing edges
 - Zero in case of other edges
- [n][12] - Riser thickness at the edge starting from this point.
 - Zero in case of connection polygons
 - Thickness of the riser below leading edges
 - Thickness of the riser above trailing edges
 - Zero in case of other edges
- [n][13] - Riser gap thickness at the edge starting from this point.
 - Zero in case of connection polygons
 - Gap thickness of the riser below leading edges
 - Gap thickness of the riser above trailing edges
 - Zero in case of other edges
- [n][14] - Cantilevered structure horizontal thickness (read from its `ac_stairStructureHorizThick` parameter) at the edge starting from this point.
 - Zero in case of connection polygons
 - Horizontal thickness of the cantilevered structure below leading edges
 - Horizontal thickness of the cantilevered structure above trailing edges
 - Zero in case of other edges

STAIR_STRUCTURE_FLAGS

array with two dimensions ([n][3]), where n is the number of structure polygons points of the current flight/landing.

2D	✓	3D	✓	UI	✓	Parameter	✗	Property	✗	Default	[0]
----	---	----	---	----	---	-----------	---	----------	---	---------	-----

- $[n][1]$ - polygon type of node n in the structure polygon: core or connection polygon
- $[n][2]$ - indicates which side node n belongs to: left or right structure polygon where the divide is the centerline of the stair: 0 - left, 1 - right
- $[n][3]$ - type of edge starting from node n. Possible values: 0 - leading edge, 1 - trailing edge, 2 - left edge, 3 - right edge, 4 - centerline edge, -1 - end edge.

values: indicators of node categories for $[n][1]$

-1: No Connection (Whole Tread) Polygon: in case of landing, all points are in this category. No such value in case of flight polygons.

0: No Connection (Core) Polygon: in case of landing, start-end connections may affect the geometry. In case of flight, the polygon is always complete.

1: Start Connection Polygon: indicates the leftover polygon, or the enclosed polygon between core and connection polygons. Nodes necessary to define beam-path: startpoint or endpoint with boundary polygon points.

2: Start Connection Position Polygon: indicates the position of the connection. This polygon is always a generic unit polygon, not part of beam-path, and only necessary for the cutting plane and end plate position.

3: Start Connection Break Polygon: indicates the polygon containing the breakpoints in case of a vertical or horizontal connection. Points necessary for beam-path: startpoint or endpoint completed with boundary polygon points.

4: Start Connection Direction Polygon: indicates the polygon needed to do the bisector cut in case of a bisector connection. This polygon is always a generic unit polygon, not part of beam-path, and only necessary to get the cutting plane position.

5: Start Connection Extension Polygon: indicates points of beam extension to support cuttings. Points necessary for beam-path: startpoint or endpoint completed with boundary polygon points.

6: Start Connection Structure Border Polygon: indicates the beam-boundary points at start. This polygon is always a generic unit polygon. Points necessary for beam-path: startpoint or endpoint.

101: End Connection Polygon: indicates the leftover polygon, or the enclosed polygon between core and connection polygons. Nodes necessary to define beam-path: startpoint or endpoint with boundary polygon points.

102: End Connection Position Polygon: indicates the position of the connection. This polygon is always a generic unit polygon, not part of beam-path, and only necessary for the cutting plane and end plate position.

103: End Connection Break Polygon: indicates the polygon containing the breakpoints in case of a vertical or horizontal connection. Points necessary for beam-path: startpoint or endpoint completed with boundary polygon points.

104: End Connection Direction Polygon: indicates the polygon needed to do the bisector cut in case of a bisector connection. This polygon is always a generic unit polygon, not part of beam-path, and only necessary to get the cutting plane position.

105: End Connection Extension Polygon: indicates points of beam extension to support cuttings. Points necessary for beam-path: startpoint or endpoint completed with boundary polygon points.

106: End Connection Structure Border Polygon: indicates the beam-boundary points at end. This polygon is always a generic unit polygon. Points necessary for beam-path: startpoint or endpoint.

STAIR_STRUCTURE_CONN_OFFSETS array with two dimensions ([2][6]). Contains data of connection offset points.

2D	✔	3D	✔	UI	✔	Parameter	✘	Property	✘	Default	[0]
----	---	----	---	----	---	-----------	---	----------	---	---------	-----

- [1][1] - Start connection horizontal offset (dx)
- [1][2] - Start connection vertical offset (dy)
- [1][3] - Start connection horizontal offset 2 (dx1)
- [1][4] - Start connection vertical offset 2 (dy1)
- [1][5] - Start connection horizontal offset (cx)
- [1][6] - Start connection vertical offset (cy)
- [2][1] - End connection horizontal offset (dx)
- [2][2] - End connection vertical offset (dy)
- [2][3] - End connection horizontal offset 2 (dx1)
- [2][4] - End connection vertical offset 2 (dy1)
- [2][5] - End connection horizontal offset (cx)
- [2][6] - End connection vertical offset (cy)

STAIR_STRUCTURE_CONN_FLAGS array with two dimensions ([2][3]). Contains additional data of the structure connection.

2D	✔	3D	✔	UI	✔	Parameter	✘	Property	✘	Default	0
----	---	----	---	----	---	-----------	---	----------	---	---------	---

- [1][1] - Start connection type: 0 - vertical cut, 1 - Horizontal cut, 2 - cutout, 3 - vertical and horizontal cut, 4 - horizontal connection, 5 - horizontal connection and cutout, 6 - vertical connection, 7 - bisector, 8 - automatic.
- [1][2] - Start connection role: 0 - run and start, 1 - run and landing, 2 - landing and run, 3 - run and run, 4 - run and end, 5 - landing and landing.
- [1][3] - Tread or riser by start: 0 - riser by start, 1 - tread by start.
- [2][1] - End connection type: 0 - vertical cut, 1 - Horizontal cut, 2 - cutout, 3 - vertical and horizontal cut, 4 - horizontal connection, 5 - horizontal connection and cutout, 6 - vertical connection, 7 - bisector, 8 - automatic.
- [2][2] - End connection role: 0 - run and start, 1 - run and landing, 2 - landing and run, 3 - run and run, 4 - run and end, 5 - landing and landing.
- [2][3] - Tread or riser by end: 0 - riser by end, 1 - tread by end.

STAIR_STRINGER_PATH_OFFSET contains the value set in "Height above Treads" in Stair Settings dialog.

2D	✘	3D	✔	UI	✘	Parameter	✘	Property	✘	Default	0
----	---	----	---	----	---	-----------	---	----------	---	---------	---

Railing component parameters

General railing variables - available for listing and labels

Compatibility: introduced in ARCHICAD 21.

RAILING_HEIGHT												height of the railing segment (as set in Railing Settings Dialog / Segment Settings)
2D	✓	3D	✗	UI	✓	Parameter	✓	Property	✗	Default	0	
RAILING_3DLENGTH												full 3D length of the railing
2D	✓	3D	✗	UI	✓	Parameter	✓	Property	✗	Default	0	
RAILING_HORIZONTAL_LENGTH												full projected 2D length of the railing
2D	✓	3D	✗	UI	✓	Parameter	✓	Property	✗	Default	0	
RAILING_VOLUME												volume of the railing (including all subelements)
2D	✓	3D	✗	UI	✓	Parameter	✓	Property	✗	Default	0	
RAILING_NR_OF_SEGMENTS												number of segments in the railing
2D	✓	3D	✗	UI	✓	Parameter	✓	Property	✗	Default	0	
RAILING_NR_OF_POSTS												number of posts in the railing
2D	✓	3D	✗	UI	✓	Parameter	✓	Property	✗	Default	0	
RAILING_NR_OF_BALUSTERS												number of balusters in the railing
2D	✓	3D	✗	UI	✓	Parameter	✓	Property	✗	Default	0	
RAILING_NR_OF_PANELS												number of panels in the railing
2D	✓	3D	✗	UI	✓	Parameter	✓	Property	✗	Default	0	
RAILING_NR_OF_RAILS												number of rails in the railing
2D	✓	3D	✗	UI	✓	Parameter	✓	Property	✗	Default	0	

Railing 3D variables

Compatibility: introduced in ARCHICAD 21.

RAILING_REFLINE_DISTANCE		array with one dimension ([2]), horizontal offsets of rail element from railing reference line.									
2D	✓	3D	✓	UI	✗	Parameter	✗	Property	✗	Default	[0]
<ul style="list-style-type: none"> • [1] - offset of segment reference line from the railing reference line • [2] - offset of panel element from the segment reference line (always 0 in case of inner post, post or toprail) 											
RAIL_CONNECTING_POSTS_NUM		number of posts and inner posts intersecting the rail.									
2D	✗	3D	✓	UI	✗	Parameter	✗	Property	✗	Default	0
RAIL_CONNECTING_POSTS		array with two dimensions ([n][2]), where n is the number of posts or inner posts along the rail. Contains position data of these intersecting elements.									
2D	✓	3D	✓	UI	✗	Parameter	✗	Property	✗	Default	[0]
<ul style="list-style-type: none"> • [n][1] - position of posts and inner posts along the rail. Position values are calculated proportionally regarding the rail length (values are between 0-1) • [n][2] - skew value of post or inner post (similar as in the case of panel). Corner element values may differ from inbetween elements'. 											
RAIL_TYPE		contains the subelement type the current library part is selected for.									
2D	✗	3D	✓	UI	✓	Parameter	✓	Property	✗	Default	0
<ul style="list-style-type: none"> • 1 - toprail (or toprail end) • 2 - handrail (or handrail end) • 3 - rail (or rail end) 											
RAIL_POLYLINE_GEOMETRY		array with two dimensions ([n][5]), where n is the number of railing nodes (n > 2). Contains geometric data of the current railing, all segments.									
2D	✗	3D	✓	UI	✗	Parameter	✗	Property	✗	Default	[0]
<ul style="list-style-type: none"> • [n][1] - coordinate x of railing node • [n][2] - coordinate y of railing node • [n][3] - coordinate z of railing node • [n][4] - central angle of edge starting from the node (0 - straight, > 0 - curved counter-clockwise, < 0 - curved clockwise) • [n][5] - rotation of the cross-section for TUBE command. The rotation of automatically extended twisted railing connections may differ from slant value. 											

RAIL_SEGMENT_FLAGS

array with one dimension ([n]), where n is the number of railing nodes ($n > 2$). Contains geometric data of the current railing, all segments.

2D	⊖	3D	✓	UI	⊖	Parameter	⊖	Property	⊖	Default	[0]
----	---	----	---	----	---	-----------	---	----------	---	---------	-----

Identifies the segment the node belongs to by index, in accordance with RAIL_POLYLINE_GEOMETRY. Nodes in the same segment belong together.

RAIL_CUTS

array with two dimensions ([2][4]), defines the orientation of the end surfaces of the rail

2D	⊖	3D	✓	UI	⊖	Parameter	⊖	Property	⊖	Default	[0]
----	---	----	---	----	---	-----------	---	----------	---	---------	-----

The returned coordinates can be used in TUBE command for first and last path coordinates as is. Items of [1][n] belong to the starting vertex, while [2][n] sets coordinates of the ending vertex.

- [1][1] - coordinate x
- [1][2] - coordinate y
- [1][3] - coordinate z
- [1][4] - boolean, cutting method: 0 - continuous edges, 1 - mitered cut

RAIL_DISCONNECTED_CUTS

array with two dimensions ([2][4]), defines the orientation of the end surfaces in case of disconnected connection.

2D	⊖	3D	✓	UI	⊖	Parameter	⊖	Property	⊖	Default	[0]
----	---	----	---	----	---	-----------	---	----------	---	---------	-----

The returned coordinates can be used in TUBE command for first and last path coordinates as is. Items of [1][n] belong to the end vertex of the first segment, while [2][n] sets coordinates at the starting vertex of the second segment.

- [1][1] - coordinate x
- [1][2] - coordinate y
- [1][3] - coordinate z
- [1][4] - 0 (reserved for future development)

Compatibility: introduced in ARCHICAD 22.

RAIL_COMPONENTS

array with one dimension ([3]), contains additional information about the rail.

2D	✓	3D	✓	UI	⊖	Parameter	⊖	Property	⊖	Default	[0]
----	---	----	---	----	---	-----------	---	----------	---	---------	-----

Boolean type to indicate the need/presence of fixings, caps.

- [1] - presence of fixings needed (none for connections or extensions)
- [2] - presence of opening caps needed (start of rail, or connected to another)
- [3] - presence of closing caps needed (end of rail, or connected to another)

RAIL_SLANT_ANGLE rail slant angle in degrees relative to vertical direction, perpendicular to walking direction.

2D	⊖	3D	✓	UI	⊖	Parameter	⊖	Property	⊖	Default	0
----	---	----	---	----	---	-----------	---	----------	---	---------	---

values: possible values (< 90 degrees)

positive: slanting to the left relative to walking direction

negative: slanting to the right relative to walking direction

Curved sections: the angle is measured on a vertical, radial plane.

RAILINGPANEL_TYPE generic geometry type of the panel.

2D	⊖	3D	✓	UI	⊖	Parameter	⊖	Property	⊖	Default	0
----	---	----	---	----	---	-----------	---	----------	---	---------	---

- 1 - planar
- 2 - cylindrical (curved - vertical or curved - skewed)
- 3 - conic (curved - horizontal - slanted)
- 4 - twisted (curved - inclined - slanted or curved - slanted - skewed)

RAILINGPANEL_UNCUT_GEOMETRY array with two dimensions ([n][4]), where n is the number of panel nodes (n > 3). Contains geometric data of the current railing panel, complete raw geometry (without cuts).

2D	⊖	3D	✓	UI	⊖	Parameter	⊖	Property	⊖	Default	[0]
----	---	----	---	----	---	-----------	---	----------	---	---------	-----

- [n][1] - coordinate x of railing panel node
- [n][2] - coordinate y of railing panel node
- [n][3] - coordinate z of railing panel node
- [n][4] - central angle of edge starting from the node (0 - straight, > 0 - curved counter-clockwise, < 0 - curved clockwise)

RAILINGPANEL_GEOMETRY array with two dimensions ([n][5]), where n is the number of panel nodes (n > 3). Contains geometric data of the current railing panel, cutting planes applied.

2D	⊖	3D	✓	UI	⊖	Parameter	⊖	Property	⊖	Default	[0]
----	---	----	---	----	---	-----------	---	----------	---	---------	-----

- [n][1] - coordinate x of railing panel node
 - [n][2] - coordinate y of railing panel node
 - [n][3] - coordinate z of railing panel node
 - [n][4] - central angle of edge starting from the node (0 - straight, > 0 - curved counter-clockwise, < 0 - curved clockwise)
 - [n][5] - in case of a cut edge, contains the cutting plane angle (0 - perpendicular to panel). In case of a curved panel, the reference plane is tangential.
-

RAILINGPANEL_FLAGS

array with two dimensions ($[n][3]$), where n is the number of panel nodes ($n > 3$) in accordance with RAILINGPANEL_GEOMETRY. Contains geometric data of the current railing panel edges, cutting planes applied.

2D	⊖	3D	✓	UI	⊖	Parameter	⊖	Property	⊖	Default	[0]
----	---	----	---	----	---	-----------	---	----------	---	---------	-----

- $[n][1]$ - segment number of edge starting from node in the uncut panel
- $[n][2]$ - position of the edge starting from node in the cut panel (indexing according to RAILINGPANEL_SIDE_OFFSETS)
- $[n][3]$ - status bit of edge

mask: $[n][3]$ possible values

$mask = j_1 + 2*j_2$, where each j can be 0 or 1.

j_1 : edge starting from node connected to another panel

j_2 : edge starting from node is cut

RAILINGPANEL_SIDE_OFFSETS

array with one dimension ($[4]$), contains the panel offsets as set in the Railing Settings dialog, distance of neighbouring element axes in a vertical plane, slanting and skewing disregarded.

2D	⊖	3D	✓	UI	⊖	Parameter	⊖	Property	⊖	Default	[0]
----	---	----	---	----	---	-----------	---	----------	---	---------	-----

- [1] - bottom offset
- [2] - end vertex side offset
- [3] - top offset
- [4] - starting vertex side offset

RAILINGPANEL_SLANT_ANGLE

slant angle in degrees, perpendicular to walking direction. Vertical is 0 degrees, positive values mean left side, negative values mean right side of walking direction ($angle < 90$). Curved segments: measured on plane perpendicular to the start tangential plane of the segment (before skewing).

2D	⊖	3D	✓	UI	⊖	Parameter	⊖	Property	⊖	Default	0
----	---	----	---	----	---	-----------	---	----------	---	---------	---

RAILINGPANEL_SKEW_ANGLE

skew angle in degrees, parallel to walking direction. Vertical is 0 degrees, positive values mean backward, negative values mean forward skewing according to walking direction ($angle < 90$). Curved segments: measured on the start tangential plane of the segment (before slanting).

2D	⊖	3D	✓	UI	⊖	Parameter	⊖	Property	⊖	Default	0
----	---	----	---	----	---	-----------	---	----------	---	---------	---

RAILINGPOST_TYPE

contains the subelement type the current library part is selected for.

2D	✔	3D	✔	UI	✔	Parameter	✔	Property	✘	Default	0
----	---	----	---	----	---	-----------	---	----------	---	---------	---

- 1 - post
- 2 - inner post
- 3 - baluster

RAILINGPOST_TOP_COORD

array with one dimension ([3]), coordinates of the top of the current post

2D	✘	3D	✔	UI	✘	Parameter	✘	Property	✘	Default	[0, 0, 0]
----	---	----	---	----	---	-----------	---	----------	---	---------	-----------

- [1] - coordinate x
- [2] - coordinate y
- [3] - coordinate z

RAILINGPOST_CUTS

array with two dimensions ([2][3]), defines the orientation of the end surfaces of the post

2D	✘	3D	✔	UI	✘	Parameter	✘	Property	✘	Default	[0]
----	---	----	---	----	---	-----------	---	----------	---	---------	-----

The returned coordinates can be used in TUBE command for first and last path coordinates as is. Items of [1][n] belong to the base vertex, while [2][n] sets coordinates of the top vertex.

- [1][1] - coordinate x
- [1][2] - coordinate y
- [1][3] - coordinate z

RAILINGPOST_SEGMENT_CUTS

array with two dimensions ([2][4]), contains the vector parameters of two planes used to cut inner posts and balusters at the boundary of the segment, when the railing is slanted

2D	✘	3D	✔	UI	✘	Parameter	✘	Property	✘	Default	[0]
----	---	----	---	----	---	-----------	---	----------	---	---------	-----

The normal of the plane is vector (A; B; C), and D is its distance from the origin, measured in the direction of the normal. The model should be cut in the direction of the normal. In case of all 0 return values for any of the 2 planes, the plane does not exist (no cut).

- [1][1] - A
- [1][2] - B
- [1][3] - C
- [1][4] - D

RAILINGEND_DIRECTION_AND_ANGLE array with two dimensions ([n][5]), vector data pointing away from the connecting rail in a tangential direction. For two ends of a straight rail, these vectors are opponent in direction.

2D	⊖	3D	✓	UI	⊖	Parameter	⊖	Property	⊖	Default	[0]
----	---	----	---	----	---	-----------	---	----------	---	---------	-----

- [n][1] - coordinate x of vector
- [n][2] - coordinate y of vector
- [n][3] - coordinate z of vector
- [n][4] - rotation of the connecting rail around the vector's axis, with the effect of slanting. The railend should model the same rotation to connect seamlessly.

Railing 2D variables

Compatibility: introduced in ARCHICAD 21.

RAIL2D_FULL_POLYLINE_GEOM array with two dimensions ([n][3]), where n is the number of points in the panel/rail/rail end axis polyline. Contains geometric data of the railing panel.

2D	✓	3D	⊖	UI	⊖	Parameter	⊖	Property	⊖	Default	[0]
----	---	----	---	----	---	-----------	---	----------	---	---------	-----

- [n][1] - coordinate x of node measured from railing origin
- [n][2] - coordinate y of node measured from railing origin
- [n][3] - central angle of edge starting from the node (0 - straight, > 0 - curved counter-clockwise, < 0 - curved clockwise)

RAIL2D_FULL_POLYLINE_FLAGS array with two dimensions ([n][1]), where n is the number of points in the panel/rail/rail end axis polyline. Contains visibility data of edges.

2D	✓	3D	⊖	UI	⊖	Parameter	⊖	Property	⊖	Default	[0]
----	---	----	---	----	---	-----------	---	----------	---	---------	-----

- [n][1] - visibility flag of edge starting at node n (0 - not visible, 1 - visible)

RAIL2D_FULL_POLYGON_GEOM array with two dimensions ([n][3]), where n is the number of points in the panel/rail/rail end symbol polygon. Contains geometric data of the railing panel.

2D	✓	3D	⊖	UI	⊖	Parameter	⊖	Property	⊖	Default	[0]
----	---	----	---	----	---	-----------	---	----------	---	---------	-----

- [n][1] - coordinate x of node measured from railing origin
- [n][2] - coordinate y of node measured from railing origin
- [n][3] - central angle of edge starting from the node (0 - straight, > 0 - curved counter-clockwise, < 0 - curved clockwise)

RAIL2D_FULL_POLYGON_FLAGS array with two dimensions ([n][1]), where n is the number of points in the panel/rail/rail end symbol polygon. Contains visibility data of edges.

2D	✓	3D	✗	UI	✗	Parameter	✗	Property	✗	Default	[0]
----	---	----	---	----	---	-----------	---	----------	---	---------	-----

- [n][1] - visibility flag of edge starting at node n (0 - not visible, 1 - visible)

RAIL2D_FULL_VISIBILITY type of the active attribute set of the current railing drawing.

2D	✓	3D	✗	UI	✓	Parameter	✓	Property	✗	Default	0
----	---	----	---	----	---	-----------	---	----------	---	---------	---

values:

1: 'Visible' attribute set is in effect

0: 'Hidden' attribute set is in effect

RAIL2D_CUSTOMDISPLAY contains information about the model view settings of the railing.

2D	✓	3D	✗	UI	✗	Parameter	✗	Property	✗	Default	0
----	---	----	---	----	---	-----------	---	----------	---	---------	---

values:

0: railing is displayed according to Model View Option settings

1: railing is displayed with custom settings

The following globals are used to define the parts of the railing represented below the first breakmark.

RAIL2D_LOWER_POLYLINE_GEOM array with two dimensions ([n][3]), where n is the number of points in the panel/rail/rail end axis polyline below the first breakmark. Contains geometric data of the railing panel polyline.

2D	✓	3D	✗	UI	✗	Parameter	✗	Property	✗	Default	[0]
----	---	----	---	----	---	-----------	---	----------	---	---------	-----

- [n][1] - coordinate x of node measured from railing origin
- [n][2] - coordinate y of node measured from railing origin
- [n][3] - central angle of edge starting from the node (0 - straight, > 0 - curved counter-clockwise, < 0 - curved clockwise)

RAIL2D_LOWER_POLYLINE_FLAGS array with two dimensions ([n][1]), where n is the number of points in the panel/rail/rail end axis polyline below the first breakmark. Contains visibility data of edges.

2D	✓	3D	✗	UI	✗	Parameter	✗	Property	✗	Default	[0]
----	---	----	---	----	---	-----------	---	----------	---	---------	-----

- [n][1] - visibility flag of edge starting at node n (0 - not visible, 1 - visible)

RAIL2D_LOWER_POLYGON_GEOM

array with two dimensions ([n][3]), where n is the number of points in the panel/rail/rail end symbol polygon below the first breakmark. Contains geometric data of the railing panel polygon.

2D	✔	3D	✖	UI	✖	Parameter	✖	Property	✖	Default	[0]
----	---	----	---	----	---	-----------	---	----------	---	---------	-----

- [n][1] - coordinate x of node measured from railing origin
- [n][2] - coordinate y of node measured from railing origin
- [n][3] - central angle of edge starting from the node (0 - straight, > 0 - curved counter-clockwise, < 0 - curved clockwise)

RAIL2D_LOWER_POLYGON_FLAGS

array with two dimensions ([n][1]), where n is the number of points in the panel/rail/rail end symbol polygon below the first breakmark. Contains visibility data of polygon edges.

2D	✔	3D	✖	UI	✖	Parameter	✖	Property	✖	Default	[0]
----	---	----	---	----	---	-----------	---	----------	---	---------	-----

- [n][1] - visibility flag of edge starting at node n (0 - not visible, 1 - visible)

RAIL2D_LOWER_VISIBILITY

type of the active attribute set of the current railing drawing below the first breakmark.

2D	✔	3D	✖	UI	✔	Parameter	✔	Property	✖	Default	0
----	---	----	---	----	---	-----------	---	----------	---	---------	---

values:

- 1: 'Visible' attribute set is in effect
- 0: 'Hidden' attribute set is in effect

The following globals are used to define the parts of the railing represented between two breakmarks.

RAIL2D_MIDDLE_POLYLINE_GEOM

array with two dimensions ([n][3]), where n is the number of points in the panel/rail/rail end axis polyline between breakmarks. Contains geometric data of the railing panel polyline.

2D	✔	3D	✖	UI	✖	Parameter	✖	Property	✖	Default	[0]
----	---	----	---	----	---	-----------	---	----------	---	---------	-----

- [n][1] - coordinate x of node measured from railing origin
- [n][2] - coordinate y of node measured from railing origin
- [n][3] - central angle of edge starting from the node (0 - straight, > 0 - curved counter-clockwise, < 0 - curved clockwise)

RAIL2D_MIDDLE_POLYLINE_FLAGS

array with two dimensions ([n][1]), where n is the number of points in the panel/rail/rail end axis polyline between breakmarks. Contains visibility data of edges.

2D	✔	3D	✖	UI	✖	Parameter	✖	Property	✖	Default	[0]
----	---	----	---	----	---	-----------	---	----------	---	---------	-----

- [n][1] - visibility flag of edge starting at node n (0 - not visible, 1 - visible)

RAIL2D_MIDDLE_POLYGON_GEOM array with two dimensions ($[n][3]$), where n is the number of points in the panel/rail/rail end symbol polygon between breakmarks. Contains geometric data of the railing panel polygon.

2D	✔	3D	✘	UI	✘	Parameter	✘	Property	✘	Default	[0]
----	---	----	---	----	---	-----------	---	----------	---	---------	-----

- $[n][1]$ - coordinate x of node measured from railing origin
- $[n][2]$ - coordinate y of node measured from railing origin
- $[n][3]$ - central angle of edge starting from the node (0 - straight, > 0 - curved counter-clockwise, < 0 - curved clockwise)

RAIL2D_MIDDLE_POLYGON_FLAGS array with two dimensions ($[n][1]$), where n is the number of points in the panel/rail/rail end symbol polygon between breakmarks. Contains visibility data of polygon edges.

2D	✔	3D	✘	UI	✘	Parameter	✘	Property	✘	Default	[0]
----	---	----	---	----	---	-----------	---	----------	---	---------	-----

- $[n][1]$ - visibility flag of edge starting at node n (0 - not visible, 1 - visible)

RAIL2D_MIDDLE_VISIBILITY type of the active attribute set of the current railing drawing between breakmarks.

2D	✔	3D	✘	UI	✔	Parameter	✔	Property	✘	Default	0
----	---	----	---	----	---	-----------	---	----------	---	---------	---

values:

- 1: 'Visible' attribute set is in effect
- 0: 'Hidden' attribute set is in effect

The following globals are used to define the parts of the railing represented above the last breakmark.

RAIL2D_UPPER_POLYLINE_GEOM array with two dimensions ($[n][3]$), where n is the number of points in the panel/rail/rail end axis polyline above the last breakmark. Contains geometric data of the railing panel polyline.

2D	✔	3D	✘	UI	✘	Parameter	✘	Property	✘	Default	[0]
----	---	----	---	----	---	-----------	---	----------	---	---------	-----

- $[n][1]$ - coordinate x of node measured from railing origin
- $[n][2]$ - coordinate y of node measured from railing origin
- $[n][3]$ - central angle of edge starting from the node (0 - straight, > 0 - curved counter-clockwise, < 0 - curved clockwise)

RAIL2D_UPPER_POLYLINE_FLAGS array with two dimensions ($[n][1]$), where n is the number of points in the panel/rail/rail end axis polyline above the last breakmark. Contains visibility data of edges.

2D	✔	3D	✘	UI	✘	Parameter	✘	Property	✘	Default	[0]
----	---	----	---	----	---	-----------	---	----------	---	---------	-----

- $[n][1]$ - visibility flag of edge starting at node n (0 - not visible, 1 - visible)

RAIL2D_UPPER_POLYGON_GEOM array with two dimensions ([n][3]), where n is the number of points in the panel/rail/rail end symbol polygon above the last breakmark. Contains geometric data of the railing panel polygon.

2D	✔	3D	✘	UI	✘	Parameter	✘	Property	✘	Default	[0]
----	---	----	---	----	---	-----------	---	----------	---	---------	-----

- [n][1] - coordinate x of node measured from railing origin
- [n][2] - coordinate y of node measured from railing origin
- [n][3] - central angle of edge starting from the node (0 - straight, > 0 - curved counter-clockwise, < 0 - curved clockwise)

RAIL2D_UPPER_POLYGON_FLAGS array with two dimensions ([n][1]), where n is the number of points in the panel/rail/rail end symbol polygon above the last breakmark. Contains visibility data of polygon edges.

2D	✔	3D	✘	UI	✘	Parameter	✘	Property	✘	Default	[0]
----	---	----	---	----	---	-----------	---	----------	---	---------	-----

- [n][1] - visibility flag of edge starting at node n (0 - not visible, 1 - visible)

RAIL2D_UPPER_VISIBILITY type of the active attribute set of the current railing drawing above the last breakmark.

2D	✔	3D	✘	UI	✔	Parameter	✔	Property	✘	Default	0
----	---	----	---	----	---	-----------	---	----------	---	---------	---

values:

- 1: 'Visible' attribute set is in effect
- 0: 'Hidden' attribute set is in effect

The following global belongs to the 2D representation of railing posts.

RAILPOST2D_VISIBILITY type of the active attribute set of the current post drawing.

2D	✔	3D	✘	UI	✔	Parameter	✔	Property	✘	Default	0
----	---	----	---	----	---	-----------	---	----------	---	---------	---

values:

- 1: 'Visible' attribute set is in effect
- 0: 'Hidden' attribute set is in effect

Roof parameters - available for skylights, listing and labels

ROOF_THICKNESS thickness of the roof

ROOF_ANGLE slope of the roof

ROOF_MAT_TOP surface attribute index of the top surface of the roof

ROOF_MAT_EDGE surface attribute index of the edges of the roof

ROOF_MAT_BOTT	surface attribute index of the bottom surface of the roof
ROOF_LINETYPE	line type of the roof <i>applied on the contours only in the floor plan window</i>
ROOF_FILL	fill of the roof <i>fill index - its value is negative in case of a composite structure</i>
ROOF_FILL_PEN	pen of the fill of the roof
ROOF_FBGD_PEN	pen of the background of the fill of the roof
ROOF_COMPS_NAME	name of the composite structure of the roof
ROOF_BMAT_NAME	building material name of the roof, empty string for composite roofs
ROOF_BMAT	building material index of the roof, 0 for composite roofs <i>Compatibility: introduced in ARCHICAD 21.</i>
ROOF_SKINS_NUMBER	number of composite roof skins <i>range of 1 to 8, 0 if single fill applied</i>

ROOF_SKINS_PARAMS

parameters of the composite roof skin

array with 18 columns with arbitrary number of rows:

- [1] fill
- [2] thickness
- [3] (old contour pen)
- [4] pen of fill
- [5] pen of fill background
- [6] core status
- [7] upper line pen
- [8] upper line type
- [9] lower line pen
- [10] lower line type
- [11] end face pen
- [12] fill orientation
- [13] skin type
- [14] end face line type
- [15] finish skin status
- [16] oriented fill status
- [17] core skin status (if no core skin exists, the thickest skin)
- [18] building material index.

core status: 0 - not part, 1 - part, 3 - last skin of core, fill orientation: 0 - global, 1 - local; skin type: in the current ARCHICAD always 0 - cut, it can be used as in walls later; finish skin status: 0 not finish skin, 1: finish skin

ROOF_SKINS_BMAT_NAMES

building material names of the composite roof skin

array with 1 column: building material name of the skin and with arbitrary number of rows.

ROOF_SECT_PEN

pen of the contours of the roof cut surfaces

applied on contours of cut surfaces both in floor plan and section/ elevation windows

ROOF_VIEW_PEN

pen of the roof on view

applied on all edges in 3D window and on outline edges (edges on view below cutting plane) in floor plan and section/ elevation windows

Roof parameters - available for listing and labels only

ROOF_BOTTOM_SURF	bottom surface area of the roof <i>not reduced by the surface area of the holes, which are bigger than the given value</i>
ROOF_GROSS_BOTTOM_SURF	gross surface area of the roof bottom <i>reduced by the surface area of the holes</i>
ROOF_BOTTOM_SURF_CON	conditional bottom surface area of the roof <i>reduced by the surface area of the holes, which are bigger than the given value</i>
ROOF_TOP_SURF	top surface area of the roof <i>not reduced by the surface area of the holes, which are bigger than the given value</i>
ROOF_GROSS_TOP_SURF	gross surface area of the roof top <i>reduced by the surface area of the holes</i>
ROOF_TOP_SURF_CON	conditional surface area of the roof <i>reduced by the surface area of the holes, which are bigger than the given value</i>
ROOF_EDGE_SURF	surface area of the edge of the roof <i>not reduced by the surface area of the holes</i>
ROOF_GROSS_EDGE_SURF	gross surface area of the roof edges <i>reduced by the surface area of the holes</i>
ROOF_CONTOUR_AREA	area covered by the roof
ROOF_PERIMETER	perimeter of the roof
ROOF_VOLUME	volume of the roof <i>not reduced by the volume of holes</i>
ROOF_GROSS_VOLUME	gross volume of the roof <i>reduced by the volume of holes</i>
ROOF_VOLUME_CON	conditional volume of the roof <i>reduced by the volume of holes, which are bigger than the given value</i>

ROOF_SEGMENTS_NR	number of segments of the roof
ROOF_HOLES_NR	number of holes in the roof
ROOF_HOLES_AREA	area of holes in the roof
ROOF_HOLES_PRM	perimeter of holes in the roof
ROOF_INSU_THICKNESS	roof insulation skin thickness
ROOF_RIDGE	roof ridges length
ROOF_VALLEY	roof valleys length
ROOF_GABLE	roof gables length
ROOF_HIP	roof hips length
ROOF_EAVES	roof eaves length
ROOF_PEAK	roof peaks length
ROOF_SIDE_WALL	roof side wall connection length
ROOF_END_WALL	roof end wall connection length
ROOF_TRANSITION_DOME	roof dome connection length
ROOF_TRANSITION_HOLLOW	roof hollow connection length

Fill parameters - available for listing and labels only

FILL_LINETYPE	line type of the fill
FILL_FILL	fill type of the fill
FILL_BMAT_NAME	building material name of the fill
FILL_BMAT	building material index of the fill
<i>Compatibility: introduced in ARCHICAD 21.</i>	
FILL_FILL_PEN	pen of the fill pattern of the fill
FILL_PEN	pen of the fill
FILL_FBGD_PEN	pen of the background of the fill

FILL_SURF	area of the fill
FILL_PERIMETER	perimeter of the fill
FILL_SEGMENT_NR	number of segments of the fill
FILL_HOLES_NR	number of holes in the fill
FILL_HOLES_PRM	perimeter of holes in the fill
FILL_HOLES_AREA	area of holes in the fill
FILL_FILL_CATEGORY	fill category of the fill
	<i>0 - Draft, 1 - Cut, 2 - Cover</i>

Mesh parameters - available for listing and labels only

MESH_TYPE	type of the mesh
	<i>1 - closed body, 2 - top & edge, 3 - top surface only</i>
MESH_BASE_OFFSET	offset of the bottom surface to the base level
MESH_USEREDGE_PEN	pen of the user defined ridges of the mesh
MESH_TRIEDGE_PEN	pen of the triangulated edges of the mesh
MESH_SECT_PEN	pen of the contours of the mesh in section
	<i>applied on contours of cut surfaces of walls both in floor plan and section/ elevation windows</i>
MESH_VIEW_PEN	pen of the contours on view
	<i>applied on all edges in 3D window and on edges on view in section/ elevation windows</i>
MESH_MAT_TOP	surface attribute index of the top surface of the mesh
MESH_MAT_EDGE	surface attribute index of the edges of the mesh
MESH_MAT_BOTT	surface attribute index of the bottom surface of the mesh
MESH_LINETYPE	line type of the mesh
	<i>applied on the contours only in the floor plan window</i>
MESH_FILL	fill type of the mesh

MESH_BMAT_NAME	building material name of the mesh
MESH_BMAT	building material index of the mesh
<i>Compatibility: introduced in ARCHICAD 21.</i>	
MESH_FILL_PEN	pen of the fill of the mesh
MESH_FBGD_PEN	pen of the background of the fill of the mesh
MESH_BOTTOM_SURF	bottom surface area of the mesh
MESH_TOP_SURF	top surface area of the mesh
MESH_EDGE_SURF	surface area of the edge of the mesh
MESH_PERIMETER	perimeter of the mesh
MESH_VOLUME	volume of the mesh
MESH_SEGMENTS_NR	number of segments of the mesh
MESH_HOLES_NR	number of holes in the mesh
MESH_HOLES_AREA	area of holes in the mesh
MESH_HOLES_PRM	perimeter of holes in the mesh

Curtain Wall component parameters

CW_BOUNDARY_PLACEMENT	Placement of the curtain wall frame										
2D	✓	3D	✓	UI	✓	Parameter	✓	Property	✓	Default	0

Compatibility: introduced in ARCHICAD 22.

Contains the Placement settings of the boundary frames defined at Curtain Wall System / Member Placement.

values:

- 0 : Center on Boundary, or the actual frame is not a boundary frame.
- 1 : Inside Boundary
- 1 : Outside Boundary

GLOB_MVO_CWFRAME_DETLEVEL

Detail level of curtain wall frames set in Model View Options / Curtain Wall Options.

2D	✓	3D	✓	UI	⚠	Parameter	⊖	Property	⊖	Default	4
----	---	----	---	----	---	-----------	---	----------	---	---------	---

*Compatibility: introduced in ARCHICAD 22.***values:**

- 1: *Axis Only*
- 2: *Schematic*
- 3: *Simplified*
- 4: *Detailed*

GLOB_MVO_CWPANEL_DETLEVEL

Detail level of curtain wall panels set in Model View Options / Curtain Wall Options.

2D	✓	3D	✓	UI	⚠	Parameter	⊖	Property	⊖	Default	4
----	---	----	---	----	---	-----------	---	----------	---	---------	---

*Compatibility: introduced in ARCHICAD 22.***values:**

- 2: *Schematic*
- 3: *Simplified*
- 4: *Detailed*

GLOB_MVO_CWJUNCT_DETLEVEL

Detail level of curtain wall junctions set in Model View Options / Curtain Wall Options.

2D	✓	3D	✓	UI	⚠	Parameter	⊖	Property	⊖	Default	4
----	---	----	---	----	---	-----------	---	----------	---	---------	---

*Compatibility: introduced in ARCHICAD 22.***values:**

- 2: *Schematic*
- 3: *Simplified*
- 4: *Detailed*

GLOB_MVO_CWACC_DETLEVEL

Detail level of curtain wall accessories set in Model View Options / Curtain Wall Options.

2D	✓	3D	✓	UI	⚠	Parameter	⊖	Property	⊖	Default	4
----	---	----	---	----	---	-----------	---	----------	---	---------	---

*Compatibility: introduced in ARCHICAD 22.***values:**

- 2: *Schematic*
- 3: *Simplified*
- 4: *Detailed*

Curtain Wall parameters - available for listing and labels only

CWALL_ID	user ID of the curtain wall
CWALL_FRAMES_LENGTH	length of frames in the curtain wall
CWALL_CONTOUR_FRAMES_LENGTH	length of frames on contour in the curtain wall
CWALL_MAINAXIS_FRAMES_LENGTH	length of frames on primary gridlines in the curtain wall
CWALL_SECAXIS_FRAMES_LENGTH	length of frames on secondary gridlines in the curtain wall
CWALL_CUSTOM_FRAMES_LENGTH	length of other frames in the curtain wall
CWALL_PANELS_SURF	surface area of panels in the curtain wall
CWALL_PANELS_SURF_N	surface area of north panels in the curtain wall
CWALL_PANELS_SURF_S	surface area of south panels in the curtain wall
CWALL_PANELS_SURF_E	surface area of east panels in the curtain wall
CWALL_PANELS_SURF_W	surface area of west panels in the curtain wall
CWALL_PANELS_SURF_NE	surface area of northeast panels in the curtain wall
CWALL_PANELS_SURF_NW	surface area of northwest panels in the curtain wall
CWALL_PANELS_SURF_SE	surface area of southeast panels in the curtain wall
CWALL_PANELS_SURF_SW	surface area of southwest panels in the curtain wall
CWALL_SURF	surface area of the curtain wall
CWALL_SURF_BOUNDARY	surface area of the curtain wall bordered by boundary frames
CWALL_LENGTH	length of the curtain wall
CWALL_HEIGHT	height of the curtain wall
CWALL_SLANT_ANGLE	slant angle of the curtain wall
CWALL_THICKNESS	thickness of the curtain wall
CWALL_PANELS_NR	number of panels in the curtain wall
CWALL_PATTERN_ANGLE	pattern angle of the curtain wall

Curtain Wall Frame parameters

General Curtain Wall Frame variables - available for listing and labels only

CWFRAME_TYPE	type of the frame <i>'Invisible' or the name of the GDL object</i> <i>Compatibility: up to ARCHICAD 21 'Generic', 'Butt-glazed', 'Invisible' or the name of the GDL object</i>
CWFRAME_POSITION	location of the frame. From ARCHICAD 22 the frame position definition is based on the frames relative coordinate values. <i>0 - vertical, 1 - horizontal, 2 - contour, 3 - diagonal</i> <i>Compatibility: up to ARCHICAD 21 the frame position definition is based on the gridlines. The values refers to: 0 - primary gridline, 1 - secondary gridline, 2 - boundary, 3 - other</i>
CWFRAME_DIRECTION	slant angle of the frame <i>degree between 0 and 90</i>
CWFRAME_WIDTH	width of the frame
CWFRAME_DEPTH	depth of the frame
CWFRAME_LENGTH	length of the frame
CWFRAME_MAT	surface attribute index of the frame

Curtain Wall Frame 3D variables

CWFRAME_TOP_CUTTYPE	Defines the cutting method at the curtain wall frame top connection.										
2D	⊖	3D	✔	UI	⊖	Parameter	⊖	Property	⊖	Default	0

Compatibility: introduced in ARCHICAD 22.

values:

- 0: Plane - the frame should be cut by a plane defined in CWFRAME_TOP_CUTPLANE global*
- 1: Polyline - the frame should be cut along a polyline defined in CWFRAME_TOP_CUTPOLYLINE global*

CWFRAME_TOP_CUTPLANE

array with one dimension ([4]), containing the top cutplane position of the frame, defined in the local coordinate system of the library part

2D	⊖	3D	✓	UI	⊖	Parameter	⊖	Property	⊖	Default	[0, 0, 0, 0]
----	---	----	---	----	---	-----------	---	----------	---	---------	--------------

Compatibility: introduced in ARCHICAD 22.

values:

- [1]: X component of the normal vector of top cutplane
- [2]: Y component of the normal vector of top cutplane
- [3]: Z component of the normal vector of top cutplane
- [4]: distance of top cutplane from frame origo

CWFRAME_TOP_CUTPOLYLINE

array with two dimensions ([n][2]), where n is the number of nodes of the cutting polyline. Contains the cutting polyline coordinates for the top connection of the frame, defined in the Y-Z plane of the local coordinate system of the library part. The first node of the polyline is on the minimal Y coordinate value, the last node is on the maximal Y coordinate value of the curtain wall frame.

2D	⊖	3D	✓	UI	⊖	Parameter	⊖	Property	⊖	Default	[0, 0]
----	---	----	---	----	---	-----------	---	----------	---	---------	--------

Compatibility: introduced in ARCHICAD 22.

values:

- [n] [1]: coordinate X of node measured from curtain wall frame origin
- [n] [2]: coordinate Y of node measured from curtain wall frame origin

CWFRAME_BOTTOM_CUTTYPE

Defines the cutting method at the curtain wall frame bottom connection.

2D	⊖	3D	✓	UI	⊖	Parameter	⊖	Property	⊖	Default	0
----	---	----	---	----	---	-----------	---	----------	---	---------	---

Compatibility: introduced in ARCHICAD 22.

values:

- 0: Plane - the frame should be cut by a plane defined in CWFRAME_BOTTOM_CUTPLANE global
- 1: Polyline - the frame should be cut along a polyline defined in CWFRAME_BOTTOM_CUTPOLYLINE global

CWFRAME_BOTTOM_CUTPLANE array with one dimension ([4]), containing the bottom cutplane position of the frame, defined in the local coordinate system of the library part

2D	❌	3D	✅	UI	❌	Parameter	❌	Property	❌	Default	[0, 0, 0, 0]
----	---	----	---	----	---	-----------	---	----------	---	---------	--------------

Compatibility: introduced in ARCHICAD 22.

values:

- [1]: X component of the normal vector of bottom cutplane
- [2]: Y component of the normal vector of bottom cutplane
- [3]: Z component of the normal vector of bottom cutplane
- [4]: distance of bottom cutplane from frame origo

CWFRAME_BOTTOM_CUTPOLYLINE array with two dimensions ([n][2]), where n is the number of nodes of the cutting polyline. Contains the cutting polyline coordinates for the bottom connection of the frame, defined in the Y-Z plane of the local coordinate system of the library part. The first node of the polyline is on the minimal Y coordinate value, the last node is on the maximal Y coordinate value of the curtain wall frame.

2D	❌	3D	✅	UI	❌	Parameter	❌	Property	❌	Default	[0, 0]
----	---	----	---	----	---	-----------	---	----------	---	---------	--------

Compatibility: introduced in ARCHICAD 22.

values:

- [n] [1]: coordinate X of node measured from curtain wall frame origin
- [n] [2]: coordinate Y of node measured from curtain wall frame origin

Curtain Wall Panel variables

CWPANEL_HORIZONTAL_DIRECTION angle of exterior surface of the panel from Project North.

2D	✅	3D	✅	UI	❌	Parameter	❌	Property	❌	Default	[180]
----	---	----	---	----	---	-----------	---	----------	---	---------	-------

Compatibility: introduced in ARCHICAD 22 for 2D and 3D scripts. In previous versions it is working only for labels and listing.

values: degree between -180 and 180

CWPANEL_VERTICAL_DIRECTION slant angle of exterior surface of the panel.

2D	✅	3D	✅	UI	❌	Parameter	❌	Property	❌	Default	[90]
----	---	----	---	----	---	-----------	---	----------	---	---------	------

Compatibility: introduced in ARCHICAD 22 for 2D and 3D scripts. In previous versions it is working only for labels and listing.

values: degree between -90 and 90

Curtain Wall Panel parameters - available for listing and labels only

CWPANEL_TYPE	type of the panel <i>"Generic" or the name of the GDL object</i>
CWPANEL_CLASS	class of the panel <i>0 - main, 1 - distinct, 2 - custom</i>
CWPANEL_WIDTH	width of the panel
CWPANEL_NOMINAL_WIDTH	nominal width of the panel
CWPANEL_HEIGHT	height of the panel
CWPANEL_NOMINAL_HEIGHT	nominal height of the panel
CWPANEL_THICKNESS	thickness of the panel
CWPANEL_SURF	surface area of the panel
CWPANEL_GROSS_SURF	gross surface area of the panel
CWPANEL_NOMINAL_SURF	nominal surface area of the panel
CWPANEL_PERIMETER	perimeter of the panel
CWPANEL_MAT_OUTER	surface attribute index for the exterior surface of the panel
CWPANEL_MAT_INNER	surface attribute index for the interior surface of the panel
CWPANEL_MAT_CUT	surface attribute index for the edge of the panel
CWPANEL_FUNCTION	function of the panel <i>0 - fixed, 1 - door, 2 - window</i>
CWPANEL_ORIENTATION	opening orientation of door/window panel <i>left/right</i>

Curtain Wall Junction parameters - available for listing and labels only

CWJUNC_TYPE	type of the junction <i>name of the GDL object</i>
--------------------	---

Curtain Wall Accessory parameters - available for listing and labels only

CWACC_TYPE	type of the accessory
<i>name of the GDL object</i>	

Migration parameters - available for migration scripts only

FROM_GUID	Main GUID of the library part which was placed originally
TO_GUID	Main GUID of the library part to which the migration is performed

Skylight parameters - available for listing and labels only

SKYL_MARKER_TXT	skylight marker text
SKYL_OPENING_SURF	skylight opening surface
SKYL_OPENING_VOLUME	volume of the opening cut by the skylight
SKYL_OPENING_HEIGHT	skylight opening height
SKYL_OPENING_WIDTH	skylight opening width
SKYL_HEADER_HEIGHT	skylight header height
SKYL_SILL_HEIGHT	skylight sill height

Common Parameters for Shells and Roofs - available for listing and labels only

SHELLBASE_THICKNESS	thickness of the shell/roof/slab
<i>equal to ROOF_THICKNESS for roofs</i>	
SHELLBASE_MAT_REFERENCE	surface attribute index of the bottom surface of the shell/roof
<i>equal to ROOF_MAT_BOTT for roofs</i>	
SHELLBASE_MAT_EDGE	surface attribute index of the edges of the shell/roof
<i>equal to ROOF_MAT_EDGE for roofs</i>	
SHELLBASE_MAT_OPPOSITE	surface attribute index of the top surface of the shell/roof
<i>equal to ROOF_MAT_TOP for roofs</i>	

SHELLBASE_LINETYPE	line type of the shell/roof <i>applied on the contours only in the floor plan window, equal to ROOF_LINETYPE for roofs</i>
SHELLBASE_FILL	fill of the shell/roof <i>fill index - its value is negative in case of a composite structure, equal to ROOF_FILL for roofs</i>
SHELLBASE_FILL_PEN	pen of the fill of the roof shell/roof <i>equal to ROOF_FILL_PEN for roofs</i>
SHELLBASE_FBGD_PEN	pen of the background of the fill of the shell/roof <i>equal to ROOF_FBGD_PEN for roofs</i>
SHELLBASE_COMPS_NAME	name of the composite structure of the shell/roof <i>equal to ROOF_COMPS_NAME for roofs</i>
SHELLBASE_BMAT_NAME	building material name of the shell/roof <i>equal to ROOF_BMAT_NAME for roofs</i>
SHELLBASE_BMAT	building material index of the shell/roof <i>Compatibility: introduced in ARCHICAD 21. equal to ROOF_BMAT for roofs</i>
SHELLBASE_SKINS_NUMBER	number of composite roof skins shell/roof <i>range of 1 to 8, 0 if single fill applied, equal to ROOF_SKINS_NR for roofs</i>

SHELLBASE_SKINS_PARAMS

parameters of the composite roof skin shell/roof

array with 18 columns with arbitrary number of rows:

- [1] fill
- [2] thickness
- [3] (old contour pen)
- [4] pen of fill
- [5] pen of fill background
- [6] core status
- [7] upper line pen
- [8] upper line type
- [9] lower line pen
- [10] lower line type
- [11] end face pen
- [12] fill orientation
- [13] skin type
- [14] end face line type
- [15] finish skin status
- [16] oriented fill status
- [17] core skin status (if no core skin exists, the thickest skin)
- [18] building material index.

*core status: 0 - not part, 1 - part, 3 - last skin of core, fill orientation: 0 - global, 1 - local; skin type: in the current ARCHICAD always 0 - cut, it can be used as in walls later; finish skin status: 0 not finish skin, 1: finish skin**equal to ROOF_SKINS_PARAMS for roofs*

SHELLBASE_SKINS_BMAT_NAMES

building material names of the composite roof skin shell/roof

*array with 1 column: building material name of the skin and with arbitrary number of rows.**equal to ROOF_SKINS_BMAT_NAMES for roofs*

SHELLBASE_SECT_PEN

pen of the contours of the roof cut surfaces shell/roof

applied on contours of cut surfaces both in floor plan and section/elevation windows, equal to ROOF_SECT_PEN for roofs

SHELLBASE_VIEW_PEN

pen of the roof on view shell/roof

applied on all edges in 3D window and on outline edges (edges on view below cutting plane) in floor plan and section/elevation windows, equal to ROOF_VIEW_PEN for roofs

SHELLBASE_REFERENCE_SURF	reference side surface of the shell/roof <i>not reduced by the surface of holes, equal to ROOF_BOTTOM_SURF for roofs</i>
SHELLBASE_COND_REFERENCE_SURF	conditional reference side surface of the shell/roof <i>equal to ROOF_BOTTOM_SURF_CON for roofs</i>
SHELLBASE_GROSS_REFERENCE_SURF	gross surface of the shell/roof reference side <i>reduced by the surface of the holes, equal to ROOF_GROSS_BOTTOM_SURF for roofs</i>
SHELLBASE_OPPOSITE_SURF	surface of the opposite side to the reference side of the shell/roof <i>not reduced by the surface of holes, equal to ROOF_TOP_SURF for roofs</i>
SHELLBASE_COND_OPPOSITE_SURF	conditional surface of the opposite side to the reference side of the shell/roof <i>reduced by the surface of the holes, which are bigger than the given value; equal to ROOF_TOP_SURF_CON for roofs</i>
SHELLBASE_GROSS_OPPOSITE_SURF	gross surface of the opposite side to the reference side of the shell/roof <i>reduced by the surface of the holes, equal to ROOF_GROSS_TOP_SURF for roofs</i>
SHELLBASE_EDGE_SURF	surface of the edge of the shell/roof <i>not reduced by the surface of holes, equal to ROOF_EDGE_SURF for roofs</i>
SHELLBASE_GROSS_EDGE_SURF	gross surface of the shell/roof edges <i>reduced by the surface of holes, equal to ROOF_GROSS_EDGE_SURF for roofs</i>
SHELLBASE_PERIMETER	perimeter of the shell/roof <i>equal to ROOF_PERIMETER for roofs</i>
SHELLBASE_VOLUME	volume of the shell/roof <i>not reduced by the volume of holes, equal to ROOF_VOLUME for roofs</i>
SHELLBASE_COND_VOLUME	conditional volume of the roof shell/roof <i>reduced by the volume of holes, which are bigger than the given value; equal to ROOF_VOLUME_CON for roofs</i>
SHELLBASE_GROSS_VOLUME	gross volume of the roof shell/roof <i>reduced by the volume of holes, equal to ROOF_GROSS_VOLUME for roofs</i>

SHELLBASE_HOLES_NR	number of holes in the shell/roof
<i>equal to ROOF_HOLES_NR for roofs</i>	
SHELLBASE_HOLES_SURF	surface of holes in the shell/roof
<i>equal to ROOF_HOLES_AREA for roofs</i>	
SHELLBASE_HOLES_PRM	perimeter of holes in the shell
<i>equal to ROOF_HOLES_PRM for roofs</i>	
SHELLBASE_OPENINGS_NR	number of openings in the shell
SHELLBASE_OPENINGS_SURF	surface of openings in the shell
SHELLBASE_INSU_THICKNESS	shell/roof insulation skin thickness
<i>equal to ROOF_INSU_THICKNESS for roofs</i>	
SHELLBASE_RIDGE	shell/roof ridges length
<i>equal to ROOF_RIDGE for roofs</i>	
SHELLBASE_VALLEY	shell/roof valleys length
<i>equal to ROOF_VALLEY for roofs</i>	
SHELLBASE_GABLE	shell/roof gables length
<i>equal to ROOF_GABLE for roofs</i>	
SHELLBASE_HIP	shell/roof hips length
<i>equal to ROOF_HIP for roofs</i>	
SHELLBASE_EAVES	shell/roof eaves length
<i>equal to ROOF_EAVES for roofs</i>	
SHELLBASE_PEAK	shell/roof peaks length
<i>equal to ROOF_PEAK for roofs</i>	
SHELLBASE_SIDE_WALL	shell/roof side wall connection length
<i>equal to ROOF_SIDE_WALL for roofs</i>	

SHELLBASE_END_WALL	shell/roof end wall connection length
---------------------------	---------------------------------------

equal to ROOF_END_WALL for roofs

SHELLBASE_TRANSITION_DOME	shell/roof dome connection length
----------------------------------	-----------------------------------

equal to ROOF_TRANSITION_DOME for roofs

SHELLBASE_TRANSITION_HOLLOW	shell/roof hollow connection length
------------------------------------	-------------------------------------

equal to ROOF_TRANSITION_HOLLOW for roofs

Parameters for Morphs - available for listing and labels only

MORPH_LINETYPE	Line type of the morph on view
-----------------------	--------------------------------

MORPH_FILL	Fill of the morph cut surfaces
-------------------	--------------------------------

MORPH_BMAT_NAME	Building material name of the morph cut surfaces
------------------------	--

MORPH_BMAT	Building material index of the morph cut surfaces
-------------------	---

Compatibility: introduced in ARCHICAD 21.

MORPH_FILL_PEN	Pen of the morph cut surfaces
-----------------------	-------------------------------

MORPH_FBGD_PEN	Pen of the background of the fill of the morph cut surfaces
-----------------------	---

MORPH_SECT_LINETYPE	Line type of the contours of the morph cut surfaces
----------------------------	---

MORPH_SECT_PEN	Pen of the contours of the morph cut surfaces
-----------------------	---

MORPH_VIEW_PEN	Pen of the contours of the morph on view
-----------------------	--

MORPH_SOLID	Morph body solid (on/off)
--------------------	---------------------------

MORPH_MAT_DEFAULT	Morph default surface attribute index
--------------------------	---------------------------------------

MORPH_CASTS_SHADOW	Cast shadow (on/off)
---------------------------	----------------------

MORPH_RECEIVES_SHADOW	Receive shadow (on/off)
------------------------------	-------------------------

MORPH_SURFACE	Gross surface of the morph
----------------------	----------------------------

MORPH_VOLUME	Volume of the morph
---------------------	---------------------

MORPH_FLOOR_PERIMETER	perimeter of the morph on the floor plan
------------------------------	--

Example usage of global variables

Example: Illustrating the usage of the GLOB_WORLD_ORIGO... globals

```

ADD2 -GLOB_WORLD_ORIGO_OFFSET_X-SYMB_POS_X, -GLOB_WORLD_ORIGO_OFFSET_X-SYMB_POS_Y
LINE2 -0.1, 0.0, 0.1, 0.0
LINE2 0.0, -0.1, 0.0, 0.1
HOTSPOT2 0.0, 0.0, 1
TEXT2 0, 0, "( 0.00 ; 0.00 )"
TEXT2 0, 0.5, "World Origin"
DEL TOP
if ABS(GLOB_WORLD_ORIGO_OFFSET_X) > 0.01 OR\
    ABS(GLOB_WORLD_ORIGO_OFFSET_Y) > 0.01 THEN
    ADD2 -SYMB_POS_X, -SYMB_POS_Y
    LINE2 -0.1, 0.0, 0.1, 0.0
    LINE2 0.0, -0.1, 0.0, 0.1
    HOTSPOT2 0.0, 0.0, 2
    TEXT2 0, 0, "(" +
        STR (GLOB_WORLD_ORIGO_OFFSET_X, 9, 4) + "; " +
        STR (GLOB_WORLD_ORIGO_OFFSET_Y, 9, 4) + " )"
    TEXT2 0, 0.5, "Virtual Origin"
    DEL TOP
ENDIF
if ABS(GLOB_WORLD_ORIGO_OFFSET_X + SYMB_POS_X) > 0.01 OR\
    ABS(GLOB_WORLD_ORIGO_OFFSET_Y + SYMB_POS_Y) > 0.01 THEN
    LINE2 -0.1, 0.0, 0.1, 0.0
    LINE2 0.0, -0.1, 0.0, 0.1
    HOTSPOT2 0.0, 0.0, 3
    TEXT2 0, 0, "(" +
        STR (GLOB_WORLD_ORIGO_OFFSET_X + SYMB_POS_X, 9, 4) + "; " +
        STR (GLOB_WORLD_ORIGO_OFFSET_Y + SYMB_POS_Y, 9, 4) + " )"
    TEXT2 0, 0.5, "Object Placement"
ENDIF

```

Deprecated Global Variables

These globals are still working in ARCHICAD's environment for compatibility reasons, but avoiding them is recommended during new object creation.

GLOB_CONTEXT context of appearance (view dependent, do not use in parameter/property scripts)

2D	✔	3D	✔	UI	✘	Parameter	✘	Property	✘	Default	2
----	---	----	---	----	---	-----------	---	----------	---	---------	---

1 - library part editor, 2 - floor plan, 3 - 3D view, 4 - section/elevation, 5 - settings dialog, 6 - list, 7 - detail drawing, 8 - layout, 22 - editing feedback mode from the floor plan, 23 - editing feedback mode from a 3D view, 24 - editing feedback mode from a section/elevation, 28 - editing feedback mode from a layout, 43 - generating as an operator from a 3D view, 44 - generating as an operator from a section/elevation, 46 - generating as an operator from a list. See the section called “GDL execution contexts” for more details.

Deprecated Beam/Column Global Variables - available for listing and labels only

From ARCHICAD 23 these values are available in BEAM_SEGMENT_INFO and COLU_SEGMENT_INFO global variables with uniformized value references. See also the section called “Deprecated Beam/Column parameters - available for listing and labels only”. For compatibility, they are still available on homogeneous, straight or horizontally curved Beams and on homogeneous Columns (GLOB_ELEM_TYPE = 12 or 6).

COLU_CROSSSECTION_TYPE cross-section type of the column

✘ Column Segment (27)	✔ Single-segment Column (6)	✘ Multi-segment Column (6)
-----------------------	-----------------------------	----------------------------

0 - complex profiled, 1 - rectangular, 4 - round

BEAM_CROSSSECTION_TYPE cross-section type of the beam

✘ Beam Segment (28)	✔ Single-segment Beam (12)	✘ Multi-segment Beam (12)
---------------------	----------------------------	---------------------------

0 - complex profiled, 1 - rectangular

Deprecated Label Global Variables

These globals have been replaced by fix named optional parameters starting from ARCHICAD 22 (see section). For compatibility reasons, the global variables are still maintained, so legacy object behaviour should not be affected.

Label text handling group of globals:

LABEL_ALWAYS_READABLE label text is always readable

1 if Always Readable is checked, 0 otherwise

LABEL_TEXT_WRAP wrap label text

1 if Wrap Text is checked, 0 otherwise

LABEL_TEXT_ALIGN	text alignment <i>1 - left aligned, 2 - center aligned, 3 - right aligned, 4 - full justified</i>
LABEL_TEXT_LEADING	line spacing factor
LABEL_TEXT_WIDTH_FACT	width factor
LABEL_TEXT_CHARSPLACE_FACT	spacing factor
LABEL_FONT_NAME	font name
LABEL_TEXT_SIZE	text size
LABEL_TEXT_PEN	pen of the text
LABEL_TEXT_BG_PEN	text box background pen <i>0 if opaque is off, the background pen index otherwise</i>
LABEL_FONT_STYLE	font style <i>0-normal, 1-bold, 2-italic, 4- underline</i>
LABEL_FONT_STYLE2	font style in the settings dialog box <i>0 - normal, otherwise j1 + 2*j2 + 4*j3 + 32*j6 + 64*j7 + 128*j8, j1 - bold, j2 - italic, j3 - underline, j6 - superscript, j7 - subscript, j8 - strikethrough</i>
Label pointer/frame handling group of globals:	
LABEL_CUSTOM_ARROW	use symbol arrow option on/off <i>1 if the Use symbol arrow checkbox is checked, 0 otherwise</i>
LABEL_ARROW_LINETYPE	line type of the line of the arrow
LABEL_ARROW_PEN	pen of the arrow
LABEL_FRAME_ON	label frame on/off <i>1 if the label frame is checked, 0 otherwise</i>
LABEL_FRAME_OFFSET	frame offset
LABEL_ANCHOR_POS	label anchor position <i>0 - middle, 1 - top, 2 - bottom, 3 - bottom right</i>

Deprecated Curtain Wall Frame Global Variable - available for listing and labels only

From ARCHICAD 22 User-defined curtain wall frame classes has been introduced instead of the predefined classes. For compatibility reasons, the CWFRAME_CLASS global variable is still maintained.

CWFRAME_CLASS	class of the frame
<i>2 - boundary, 3 - other</i>	
<i>Compatibility: up to ARCHICAD 21 the values can be 0 - mullion, 1 - transom, 2 - boundary, 3 - custom</i>	

Old Global Variables

Old global variable names can be used; however, the use of the new names is recommended. Each old global corresponds to a new variable with a long name.

A_	GLOB_SCALE
B_	GLOB_HISTORY_ELEV
C_	WALL_THICKNESS
D_	WALL_HEIGHT
E_	WALL_SECT_PEN
F_	WALL_FILL_PEN
G_	WALL_MAT_A
H_	WALL_MAT_B
I_	WALL_MAT_EDGE
J_	GLOB_ELEVATION
K_	WIDO_SILL
L_	SYMB_VIEW_PEN
M_	SYMB_MAT
N_	GLOB_FRAME_NR
O_	GLOB_FIRST_FRAME
P_	GLOB_LAST_FRAME
Q_	GLOB_HISTORY_HEIGHT
R_	WIDO_ORIG_DIST
S_	GLOB_USER_1
T_	GLOB_USER_2
U_	GLOB_USER_3
V_	GLOB_USER_4
W_	GLOB_USER_5
X_	GLOB_USER_6
Y_	GLOB_USER_7
Z_	GLOB_USER_8

A~	WALL_FILL
B~	WIDO_RIGHT_JAMB
C~	WIDO_THRES_DEPTH
D~	WIDO_HEAD_DEPTH
E~	WIDO_REVEAL_SIDE
F~	WIDO_FRAME_THICKNESS
G~	GLOB_USER_9
H~	WIDO_POSITION
I~	GLOB_USER_10
J~	WALL_RESOL
K~	GLOB_EYEPOS_X
L~	GLOB_EYEPOS_Y
M~	GLOB_EYEPOS_Z
N~	GLOB_TARGPOS_X
O~	GLOB_TARGPOS_Y
P~	GLOB_TARGPOS_Z
Q~	GLOB_CSTORY_ELEV
R~	GLOB_CSTORY_HEIGHT
S~	GLOB_CH_STORY_DIST
T~	GLOB_SCRIPT_TYPE
U~	GLOB_NORTH_DIR
V~	SYMB_MIRRORED
W~	SYMB_ROTANGLE
X~	SYMB_POS_X
Y~	SYMB_POS_Y
Z~	SYMB_POS_Z

FIX NAMED OPTIONAL PARAMETERS

Parameters set by ARCHICAD

The new method of ARCHICAD for providing information is the method of fixed named optional parameters. If a given library part has a parameter matching a fix named optional parameter in name and in type, ARCHICAD sets its value according to its function.

Parameters for D/W attributes (available for Door, Window, Label, Listing)

Floor plan display

ac_hole_cut_linetype	linetype
<i>pen of cut lines [floor plan and section]</i>	
ac_hole_overhead_pen	pen
<i>pen of the above view edges (overhead) [floor plan only]</i>	
ac_hole_overhead_linetype	linetype
<i>line type of the above view edges (overhead) [floor plan only]</i>	
ac_hole_uncut_pen	pen
<i>pen of the below view edges (uncut) [floor plan only]</i>	
ac_hole_uncut_linetype	linetype
<i>line type of the below view edges (uncut) [floor plan only]</i>	
ac_hole_display_option	integer
<i>floor plan display option: 1 - Projected, 2 - Projected with Overhead, 3 - Symbolic, 5 - Overhead All</i>	

Direction

ac_hole_direction_type	integer
<i>opening plane direction: 1 - Associated to Wall, 2 - Vertical</i>	
ac_wido_rotation	angle
<i>door/window rotation angle relative to the horizontal cut plane</i>	
ac_openingside	string
<i>door/window orientation parameter for listing (L - left, R - right, Custom) according to orientation definition settings (Automatic, Custom). ARCHICAD will disregard any settings of Compatibility Options/Orientation Displaying if this parameter is present.</i>	

Polygonal wall data

ac_walltype	integer
--------------------	---------

tells whether the window is in a polygonal wall or not. 1 - non polygonal, 2 - polygonal.

ac_wallContourPolygon[[3]	length
----------------------------------	--------

*The polygon of the wall in 2D points plus an extra angle value for arc sections. [set only if **ac_walltype** equals 2]*

ac_windowInWallContour[4]	integer
----------------------------------	---------

*Indices of the four vertices of the **ac_wallContourPolygon** polygon that part of the wall contour polygon as window corner points. [set only if **ac_walltype** equals 2]*

Hole position

ac_hole_position_angle	angle
-------------------------------	-------

In case of curved walls it gives the angle between the axis of the opening and the normal vector at the wall's starting point.

Anchor data

ac_vertAnchorPos	integer
-------------------------	---------

vertical anchor of D/W: 1 - Sill, 2 - Header

ac_revealAnchorPos	integer
---------------------------	---------

reveal anchor of D/W: 1 - Face, 2 - Core

ac_revealToWallCore	length
----------------------------	--------

reveal depth measured from the reveal side of the wall core.

Parameters for WALL attributes (available for Door, Window, Label, Listing)

Floor plan display

ac_wall_overhead_pen	pen
-----------------------------	-----

pen of the above view edges of the wall (overhead) [floor plan only]

ac_wall_overhead_linetype	linetype
----------------------------------	----------

line type of the above view edges of the wall (overhead) [floor plan only]

ac_wall_uncut_linetype	linetype
<i>line type of the below view edges of the wall (uncut) [floor plan only]</i>	
ac_wall_display_option	integer
<i>floor plan display option of the wall: 1 - Projected, 2 - Projected with Overhead, 3 - Symbolic, 4 - OutLines Only, 5 - Overhead All</i>	
ac_wall_show_projection_to	integer
<i>vertical view depth limitation of the wall: 1 - To Floor Plan Range, 2 - To Absolute Display Limit, 3 - Entire Element</i>	

Geometric data

ac_wall_elevation	length
<i>elevation of the wall bottom, relative to home story of the wall</i>	
ac_wall_crosssection_type	integer
<i>wall cross section type: 1 - Simple, 2 - Complex, 3 - Slanted, 4 - Trapezoid</i>	
ac_wall_profile_name	string
<i>profile name if the wall is complex with profile attribute, "Custom_Profile_i" if complex with custom profile (i being the id of the placed wall) or "n/a" if the wall is simple, slanted or trapezoid</i>	
ac_wall_slant_angle1	angle
<i>first slant angle of the wall relative to the horizontal (90 degrees if the wall is vertical)</i>	
ac_wall_slant_angle2	angle
<i>second slant angle of the wall relative to the horizontal (90 degrees if the wall is vertical)</i>	
ac_wall_direction_type	integer
<i>wall direction type; the construction method of the wall, which means the adjustment of the wall body and the reference line: 0 - Right, 1 - Left, 2 - Center (Right), 3 - Center (Left). Center values mean that the wall is set to 'Center' in the user interface, but the side notation shows how the wall acts internally.</i>	

Parameters for COLUMN attributes (available for Label, Listing)

The availability of each parameter (whether it contains meaningful data) is shown in a table with icons, with the value of the GLOB_ELEM_TYPE global variable in parentheses.

Floor plan display

ac_colu_overhead_pen pen

pen of the above view edges of the column (overhead) [floor plan only]

✓ Column Segment (27)	✓ Single-segment Column (6)	✓ Multi-segment Column (6)
-----------------------	-----------------------------	----------------------------

ac_colu_overhead_linetype linetype

line type of the above view edges of the column (overhead) [floor plan only]

✓ Column Segment (27)	✓ Single-segment Column (6)	✓ Multi-segment Column (6)
-----------------------	-----------------------------	----------------------------

ac_colu_uncut_linetype linetype

line type of the below view edges of the column (uncut) [floor plan only]

✓ Column Segment (27)	✓ Single-segment Column (6)	✓ Multi-segment Column (6)
-----------------------	-----------------------------	----------------------------

ac_colu_display_option integer

floor plan display option of the column: 1 - Projected, 2 - Projected with Overhead, 3 - Symbolic, 4 - OutLines Only, 5 - Overhead All

✓ Column Segment (27)	✓ Single-segment Column (6)	✓ Multi-segment Column (6)
-----------------------	-----------------------------	----------------------------

ac_colu_show_projection_to integer



vertical view depth limitation of the column: 1 - To Floor Plan Range, 2 - To Absolute Display Limit, 3 - Entire Element

✓ Column Segment (27)	✓ Single-segment Column (6)	✓ Multi-segment Column (6)
-----------------------	-----------------------------	----------------------------

Geometric data



ac_colu_profile_name string

profile name if the column is complex with profile attribute, "Custom_Profile_i" if complex with custom profile (i being the id of the placed column) or "n/a" if the column is rectangular or round

 Column Segment (27)	 Single-segment Column (6)	 Multi-segment Column (6)
---	---	--



ac_colu_inclination angle

inclination angle of the column relative to the horizontal line

 Column Segment (27)	 Single-segment Column (6)	 Multi-segment Column (6)
---	---	--

ac_colu_twist_angle angle

twist angle of the cross section

 Column Segment (27)	 Single-segment Column (6)	 Multi-segment Column (6)
---	---	--



Parameters for BEAM attributes (available for Label, Listing)

The availability of each parameter (whether it contains meaningful data) is shown in a table with icons, with the value of the GLOB_ELEM_TYPE global variable in parentheses.

Floor plan display



ac_beam_overhead_pen pen

pen of the above view edges of the beam(overhead) [floor plan only]

 Beam Segment (28)	 Single-segment Beam (12)	 Multi-segment Beam (12)
---	--	---

ac_beam_cut_linetype linetype

line type of the cut edges of the beam [not valid for complex profile]

 Beam Segment (28)	 Single-segment Beam (12)	 Multi-segment Beam (12)
---	--	---

ac_beam_uncut_pen pen

pen of the below view edges of the beam (uncut) [floor plan only]

✓ Beam Segment (28)	✓ Single-segment Beam (12)	✓ Multi-segment Beam (12)
---------------------	----------------------------	---------------------------

ac_beam_uncut_linetype linetype

line type of the below view edges of the beam (uncut) [floor plan only]

✓ Beam Segment (28)	✓ Single-segment Beam (12)	✓ Multi-segment Beam (12)
---------------------	----------------------------	---------------------------

ac_beam_display_option integer

floor plan display option of the beam: 1 - Projected, 2 - Projected with Overhead, 3 - Symbolic, 4 - OutLines Only, 5 - Overhead All

✓ Beam Segment (28)	✓ Single-segment Beam (12)	✓ Multi-segment Beam (12)
---------------------	----------------------------	---------------------------

ac_beam_show_projection_to integer

vertical view depth limitation of the beam: 1 - To Floor Plan Range, 2 - To Absolute Display Limit, 3 - Entire Element

✓ Beam Segment (28)	✓ Single-segment Beam (12)	✓ Multi-segment Beam (12)
---------------------	----------------------------	---------------------------

Geometric data

ac_beam_profile_name string

profile name if complex with profile attribute, "Custom_Profile_1" if complex with custom profile (1 being the id of the placed beam) or "n/a" if the beam is rectangular

✓ Beam Segment (28)	✓ Single-segment Beam (12)	✗ Multi-segment Beam (12)
---------------------	----------------------------	---------------------------

ac_beam_inclination angle

inclination angle of the beam relative to the horizontal line

✓ Beam Segment (28)	✓ Single-segment Beam (12)	✓ Multi-segment Beam (12)
---------------------	----------------------------	---------------------------

ac_beam_twist_angle angle

twist angle of the cross section (0.0 for non-complex beams)

✓ Beam Segment (28)

✓ Single-segment Beam (12)

✓ Multi-segment Beam (12)

Parameters for ROOF attributes (available for Label, Listing)

Floor plan display

ac_roof_overhead_pen pen

pen of the above view edges of the roof (overhead) [floor plan only]

ac_roof_overhead_linetype linetype

line type of the above view edges of the roof (overhead) [floor plan only]

ac_roof_display_option integer

floor plan display option of the roof: 1 - Projected, 2 - Projected with Overhead, 3 - Symbolic, 4 - OutLines Only, 5 - Overhead All

ac_roof_show_projection_to integer

vertical view depth limitation of the roof: 1 - To Floor Plan Range, 2 - To Absolute Display Limit, 3 - Entire Element

Door/Window Marker attributes

ac_wido_id string

ID of the opening

ac_wido_a_size length

opening width

ac_wido_b_size length

opening height

ac_wido_z_size length

opening depth/thickness

ac_glob_elevation	length
<i>elevation of the base line of the opening</i>	
ac_wido_subfl_thickness	length
<i>height of the subfloor wall part</i>	
ac_wido_reveal_side	boolean
<i>legacy opening reveal side value, use ac_wido_reveal_side_2 instead</i>	
ac_wido_reveal_side_2	boolean
<i>reveal side, the value of the WIDO_REVEAL_SIDE global variable set for the opening</i>	
ac_wido_mirrored	boolean
<i>mirrored state of the opening</i>	
ac_wall_thickness	length
<i>thickness of the wall at the origin of the opening</i>	
ac_wido_oversize_l	length
<i>left opening oversize</i>	
ac_wido_oversize_r	length
<i>right opening oversize</i>	
ac_wido_oversize_t	length
<i>top opening oversize</i>	
ac_wido_oversize_b	length
<i>bottom opening oversize</i>	
ac_wido_orientation	string
<i>marker position: "L" - Left, "R" - right, or any custom value set in the Details window of the library part editor according to the current mirrored state</i>	
ac_wido_type	integer
<i>1 - Door, 2 - Window</i>	

ac_symb_rotangle	angle
<i>opening rotation in the wall</i>	
ac_sill_to_curr_story	length
<i>sill height of the opening measured from the start of the story linked to the window sill</i>	
ac_sill_to_anchor_level	length
<i>sill height of the opening measured from the level of the anchor point; the anchor point may be the bottom of the wall or the selected story, accordingly</i>	

Detail/Worksheet Marker attributes

ac_showboundary	boolean
<i>Marker boundary polygon state. 0 - boundary off, 1 - boundary on.</i>	

Drawing Title attributes

ac_drawingName	string
<i>Name of the drawing.</i>	
ac_drawingNumber	string
<i>ID of the drawing.</i>	
ac_sourceFileName	string
<i>Name of the drawing source file (if the drawing comes from an external file).</i>	
ac_sourceFilePath	string
<i>Path of the drawing source file (if the drawing comes from an external file).</i>	
ac_drawingScale	string
<i>Drawing scale set for the drawing.</i>	
ac_magnification	real number
<i>Magnification percentage set for the drawing.</i>	
ac_originalDrawingScale	string
<i>Drawing scale of the originating view.</i>	

ac_enableBackReference	boolean
-------------------------------	---------

Back referencing is enabled for the drawing.

ac_backReferenceGUIDList	string array
---------------------------------	--------------

List of referred layout GUIDs. They can be used in autotext outputs.

ac_showDrawingReferences	boolean
---------------------------------	---------

Show back references.

General running context

ac_programVersion	integer
--------------------------	---------

This parameter contains the version of ARCHICAD executing the library part's scripts.

Room parameters (available for Zone Stamps)

Name	Type	Default	Description
ROOM_NAME	String	""	Zone name
ROOM_NUMBER	String	""	Zone number
ROOM_AREA	Real	0.0	Area of gross/net polygon
ROOM_PERIM	Length	0.0	Perimeter of gross/net polygon
ROOM_HOLES_PRM	Length	0.0	Perimeter of net polygon holes
ROOM_WALLS_PRM	Length	0.0	Perimeter of net polygon (with holes) but only where bordered by wall
ROOM_CORNERS	Integer	0	Corners of net polygon (with holes)
ROOM_CONCAVES	Integer	0	Concave corners of net polygon (with holes)
ROOM_WALLS_SURF	Real	0.0	Bordering walls' surfaces (bordering parts)
ROOM_DOORS_WID	Real	0.0	Doors' lengths at border
ROOM_DOORS_SURF	Real	0.0	Doors' surfaces at border
ROOM_WINDS_WID	Length	0.0	Windows' lengths at border
ROOM_WINDS_SURF	Real	0.0	Windows' surfaces at border
ROOM_BASELEV	Length	0.0	Zone level
ROOM_FL_THICK	Length	0.0	Zone subfloor thickness
ROOM_HEIGHT	Length	0.0	Zone height
ROOM_NET_AREA	Real	0.0	Area of net polygon (with holes)
ROOM_NET_PERIMETER	Length	0.0	Perimeter of net polygon (with holes)
ROOM_WALL_EXTR_AREA	Real	0.0	Reducing area by walls inside zone (not zone boundary type!)

Name	Type	Default	Description
ROOM_COLUMN_EXTR_AREA	Real	0.0	Reducing area by columns inside zone (not zone boundary type!)
ROOM_FILL_EXTR_AREA	Real	0.0	Reducing area by hatches inside zone (considering percentage!)
ROOM_LOW_EXTR_AREA	Real	0.0	Reducing area by low parts (trimmed) (considering preferences!)
ROOM_TOTAL_EXTR_AREA	Real	0.0	Sum of previous values (total extraction)
ROOM_REDUCED_AREA	Real	0.0	ROOM_NET_AREA - ROOM_TOTAL_EXTR_AREA
ROOM_AREA_FACTOR	Real	0.0	1 - Reduced_by_in_dialog / 100
ROOM_CALC_AREA	Real	0.0	ROOM_REDUCED_AREA * ROOM_AREA_FACTOR
ROOM_VOLUME	Real	0.0	Calculated from trimmed room upon net polygon
ROOM_BOUNDARY_SURF	Real	0.0	Surface of boundary side pages
ROOM_TOP_SURFACE	Real	0.0	Surface of zone top
ROOM_BOT_SURFACE	Real	0.0	Surface of zone bottom
ROOM_ROOF_TOP_SURF	Real	0.0	Surface of zone top where trimmed by a Roof
ROOM_ROOF_BOT_SURF	Real	0.0	Surface of zone bottom where trimmed by a Roof
ROOM_SLAB_TOP_SURF	Real	0.0	Surface of zone top where trimmed by a Slab
ROOM_SLAB_BOT_SURF	Real	0.0	Surface of zone bottom where trimmed by a Slab
ROOM_BEAM_TOP_SURF	Real	0.0	Surface of zone top where trimmed by a Beam
ROOM_BEAM_BOT_SURF	Real	0.0	Surface of zone bottom where trimmed by a Beam
ROOM_WALL_IN_TOP_SURF	Real	0.0	Sum of top surfaces of wall insets (or recess or niche)
ROOM_WALL_IN_BACK_SURF	Real	0.0	Sum of back surfaces of wall insets (facing to window)
ROOM_WALL_IN_SIDE_SURF	Real	0.0	Sum of side surfaces of wall insets
ROOM_POLY_STATUS	Integer	0	0>manual, 1:Auto, 2:Auto-refline

Stair related parameters

Flight / Landing Side Supported subtypes

ac_beamPlacement integer

This parameter reflects which side of the stair the stringer is placed. Compatibility: introduced in ARCHICAD 21.

- 0 - Left (when viewed as going up the stair)
 - 1 - Right
-

Riser Component subtype

ac_RiserPosition integer

This parameter reflects the current settings of riser and tread connections:

- 0 - Riser on Tread OFF
 - 1 - Riser on Tread ON
-

Stair 2D Component subtypes

ac_treadClassifications integer - array

Type of each tread (indexed from bottom upwards):

- 0 - Tread
 - 1 - Landing
-

Parameters set/read by ARCHICAD

ARCHICAD can synchronize values with library parts through parameters with predefined name and function. The list of such parameters follows below.

Stair related parameters

Structure subtype

ac_stairStructureWidth length

Width of the structure stringer, as set in the Stair Settings. Value is 0 for beam structure type.

ac_stairStructureThickness	length
<i>Thickness/ height of the beam or cantilevered structure, as set in the Stair Settings.</i>	

Parameters read by ARCHICAD

ARCHICAD can get values from library parts through parameters with predefined name and function. The list of such parameters follows below.

Objects on Floor Plan

Floor plan cutting of planar elements (i.e. skylight object, roof accessory objects)

ac_special_2d_symbol	boolean
<i>This parameter enables a 2D cutting mechanism in ARCHICAD floor plan. If the parameter is set to 1, ARCHICAD cuts the 2D model (generated by the 2D script of the libpart) according to the parameter values in: ac_symb_display_option, ac_symb_show_projection_to and ac_plane_definition. This 2D-based cut works like the display of simple roofs with the same settings. Naturally, this method gives correct output for plane-like elements only - like skylights and roof accessories. The plane of the flat object - and the plane of the cut - is defined by the parameter ac_plane_definition. In case of Skylight and Roof Accessory elements - if ac_special_2d_symbol is 1 -, the above parameters are set by the add-on automatically. In case of other elements, they should be filled in by the library developer.</i>	
ac_plane_definition	length
<i>Plane definition: ([1],[2],[3]): a point on the plane, ([4],[5],[6]): normal vector of the plane.</i>	
ac_symb_display_option	integer
<i>1 - Projected, 2 - Projected with Overhead, 3 - Symbolic, 4 - OutLines Only, 5 - Overhead All</i>	
ac_symb_show_projection_to	integer
<i>1 - To Floor Plan Range, 2 - To Absolute Display Limit, 3 - Entire Element</i>	
ac_bottomlevel	length
<i>This parameter indicates the lowest point of the object. When Show on Stories is set to All Relevant Stories, if this lowest point (calculated from the object's home story settings) is contained in a story's vertical extension, the object is displayed on the story. Top level has to be above the bottom level.</i>	
<i>ac_bottomlevel starts from the object origin of the object.</i>	
ac_toplevel	length
<i>When Show on Stories is set to All Relevant Stories this parameter tells the top of the object. The object will be visible on a story if the story's height is between the bottomlevel and the toplevel. Top level has to be above the bottom level.</i>	
<i>ac_toplevel starts from the object origin of the object.</i>	

Door/Window objects

ac_wido_sill	length
<i>This parameter provides full access to the sill depth of the opening object. The parameter can get a value list, it can be locked and hidden and its value can be set via the parameter script. Its current value will be assigned to the WIDO_SILL global variable for compatibility with older scripts.</i>	
ac_wido_hide_options	integer
<i>Via this bitfield parameter you can disable options from the window/door settings dialog. ac_wido_hide_options = j1 + 2*j2. If j1 is set, the sill depth inputs on the default ARCHICAD settings dialog is hidden. If j2 is set, the reveal settings in the settings dialog are disabled.</i>	
ac_wido_flip_once	boolean
<i>Flips the window or door once after the execution of the migration script if the parameter is present and its value is true.</i>	
ac_wido_flip_disable	integer
<i>This parameter can disable the "Flip" button on the user interface. The default value affects only the placing of the object.</i>	
<i>-1: Flip is enabled.</i>	
<i>0: Flip is disabled. The default is not flipped.</i>	
<i>1: Flip is disabled. The default is flipped.</i>	
ac_wido_mirror_once	boolean
<i>Mirrors the window or door once after the execution of the migration script if the parameter is present and its value is true.</i>	
ac_hole_hotspot_control	integer
<i>Controls whether openings have automatic hotspots. 0 - No automatic hotspots, 1 - Only in 2D, 2 - Only in 3D, 3 - Everywhere</i>	
ac_holeSideMaterial	boolean
<i>Controls the inherited surfaces of the wallhole. In case the wallhole is defined from GDL script, this parameter has no effect.</i>	
<i>1: Wallhole has the same surface as wall edge.</i>	
<i>0: Wallhole surface is divided by the sill depth line, using the inside-outside surfaces of the wall.</i>	
ac_holeMaterialCurved	boolean
<i>Controls the division line geometry of inside-outside wall surfaces of the wallhole in curved walls. In case the wallhole is defined from GDL script, this parameter has no effect.</i>	
<i>1: Surfaces connect in a curved line.</i>	
<i>0: Surfaces connect in a straight line.</i>	

Custom Component Template

ac_custom_component_type_name	string
--------------------------------------	--------

This parameter contains the name of the Custom Component Template which is displayed on the "Save Component As..." menu. It can differ from the object name.

Stair related parameters

Structure subtype

ac_beamProfileID	integer
-------------------------	---------

Index of the selected profile used for the structure beam. ARCHICAD provides the boundingbox size of the profile by the means of request options.

Flight / Landing Under Supported subtype

ac_stairStructureHorizThick	length
------------------------------------	--------

Horizontal thickness of cantilevered structure, ie. the part behind risers. Compatibility: introduced in ARCHICAD 22.

ac_stairStructureBoundsRiser	boolean
-------------------------------------	---------

This can be used for signalling that the risers should be narrower than the stair boundary. Use together with the four parameters below. Compatibility: introduced in ARCHICAD 22.

ac_stairRiserLeftBoundaryFrom	integer
--------------------------------------	---------

Stretch left edge of the risers relative to: Compatibility: introduced in ARCHICAD 22.

- -1 - Left boundary of stair
- 0 - Centerline of stair
- 1 - Right boundary of stair
- These are not necessarily parallel with eachother.

ac_stairRiserLeftBoundary	length
----------------------------------	--------

Distance of left riser edge measured from the anchor line set in ac_stairRiserLeftBoundaryFrom. Positive direction is to the right. Compatibility: introduced in ARCHICAD 22.

ac_stairRiserRightBoundaryFrom	integer
---------------------------------------	---------

Stretch right vertical edge of the risers relative to: Compatibility: introduced in ARCHICAD 22.

- -1 - Left boundary of stair
 - 0 - Centerline of stair
 - 1 - Right boundary of stair
 - These are not necessarily parallel with eachother.
-

ac_stairRiserRightBoundary

length

Distance of right riser edge measured from the anchor line set in ac_stairRiserRightBoundaryFrom. Positive direction is to the right. Compatibility: introduced in ARCHICAD 22.

Flight Under Supported Cantilever / Landing Cantilever Supported subtypes

ac_stairWallFixingWidthLeft

length

The depth of the cantilever in the wall (on the left side of the stair). Used at drawing the 2D symbol of the cantilever: any drawing beyond this will be cropped. Compatibility: introduced in ARCHICAD 21.

ac_stairWallFixingWidthRight

length

The depth of the cantilever in the wall (on the right side of the stair). Used at drawing the 2D symbol of the cantilever: any drawing beyond this will be cropped. Compatibility: introduced in ARCHICAD 21.

Railing related parameters**Railing Panel Component subtype**

ac_panelThickness

length

Thickness of panel section in the railing. Parameter value should be kept consistent with the model size via Parameter script.

Railing Rail Component subtype

ac_railWidth

length

Absolute width of the rail section measured on a plane perpendicular to rail axis. Parameter value should be kept consistent with the model size via Parameter script.

ac_railHeight

length

Absolute height of the rail section measured on a plane perpendicular to rail axis. Parameter value should be kept consistent with the model size via Parameter script.

ac_rail_boundingBox_left

length

Relative distance of the rail section bounding box left side measured from the rail section axis (RAIL_POLYLINE_GEOMETRY), on a plane perpendicular to rail axis, looking in the direction of the rail. Parameter value should be kept consistent with the model size via Parameter script. Used for section bounding box offset of the component axis.

ac_rail_boundingBox_right

length

Relative distance of the rail section bounding box right side measured from the rail section axis (RAIL_POLYLINE_GEOMETRY), on a plane perpendicular to rail axis, looking in the direction of the rail. Parameter value should be kept consistent with the model size via Parameter script. Used for section bounding box offset of the component axis.

ac_rail_boundingBox_top	length
<i>Relative distance of the rail section bounding box top measured from the rail section axis (RAIL_POLYLINE_GEOMETRY), on a plane perpendicular to rail axis, looking in the direction of the rail. Parameter value should be kept consistent with the model size via Parameter script. Used for section bounding box offset of the component axis.</i>	
ac_rail_boundingBox_bottom	length
<i>Relative distance of the rail section bounding box bottom measured from the rail section axis (RAIL_POLYLINE_GEOMETRY), on a plane perpendicular to rail axis, looking in the direction of the rail. Parameter value should be kept consistent with the model size via Parameter script. Used for section bounding box offset of the component axis.</i>	
ac_railProfileID	integer
<i>Index of the selected profile used for the rail. ARCHICAD provides the boundingbox size of the profile by the means of request options.</i>	

Railing Post Component subtype

ac_postWidth	length
<i>Absolute width of the post section measured on a plane perpendicular to post axis. Parameter value should be kept consistent with the model size via Parameter script.</i>	
ac_postHeight	length
<i>Absolute height of the post section measured on a plane perpendicular to post axis. Parameter value should be kept consistent with the model size via Parameter script.</i>	
ac_post_boundingBox_left	length
<i>Relative distance of the post section bounding box left side measured from the post section axis, on a plane perpendicular to post axis, left means the direction of the beginning of the reference line, looking from the inside. Parameter value should be kept consistent with the model size via Parameter script. Used for section bounding box offset of the component axis.</i>	
ac_post_boundingBox_right	length
<i>Relative distance of the post section bounding box right side measured from the post section axis, on a plane perpendicular to post axis, right means the direction of the end of the reference line, looking from the inside. Parameter value should be kept consistent with the model size via Parameter script. Used for section bounding box offset of the component axis.</i>	
ac_post_boundingBox_inside	length
<i>Relative distance of the post section bounding box measured horizontally from the post section axis, on a plane perpendicular to post axis, inside meaning the side a right-side handrail is placed on. Parameter value should be kept consistent with the model size via Parameter script. Used for section bounding box offset of the component axis.</i>	
ac_post_boundingBox_outside	length
<i>Relative distance of the post section bounding box measured horizontally from the post section axis, on a plane perpendicular to post axis, outside meaning the opposite side a right-side handrail is placed on. Parameter value should be kept consistent with the model size via Parameter script. Used for section bounding box offset of the component axis.</i>	
ac_postProfileID	integer
<i>Index of the selected profile used for the post. ARCHICAD provides the boundingbox size of the profile by the means of request options.</i>	

Railing End Component subtype

ac_railendWidth	length
<i>Absolute width of the railend section measured on a plane perpendicular to railend axis. Parameter value should be kept consistent with the model size via Parameter script.</i>	
ac_railendHeight	length
<i>Absolute height of the railend section measured on a plane perpendicular to railend axis. Parameter value should be kept consistent with the model size via Parameter script.</i>	
ac_railend_boundingbox_left	length
<i>Relative distance of the rail section bounding box left side measured from the railend section axis, on a plane perpendicular to railend axis, looking in the direction of the railend. Parameter value should be kept consistent with the model size via Parameter script. Used for section bounding box offset of the component axis.</i>	
ac_railend_boundingbox_right	length
<i>Relative distance of the railend section bounding box right side measured from the railend section axis, on a plane perpendicular to railend axis, looking in the direction of the railend. Parameter value should be kept consistent with the model size via Parameter script. Used for section bounding box offset of the component axis.</i>	
ac_railend_boundingbox_top	length
<i>Relative distance of the railend section bounding box top measured from the railend section axis, on a plane perpendicular to railend axis, looking in the direction of the railend. Parameter value should be kept consistent with the model size via Parameter script. Used for section bounding box offset of the component axis.</i>	
ac_railend_boundingbox_bottom	length
<i>Relative distance of the railend section bounding box bottom measured from the railend section axis, on a plane perpendicular to railend axis, looking in the direction of the railend. Parameter value should be kept consistent with the model size via Parameter script. Used for section bounding box offset of the component axis.</i>	
ac_railendProfileID	integer
<i>Index of the selected profile used for the railend. ARCHICAD provides the boundingbox size of the profile by the means of request options.</i>	

Parameters for Curtain Wall

Library parts can collaborate with ARCHICAD through values of parameters with predefined name and function. The list of such parameters related to the Curtain Wall Tool follows below.

Curtain Wall Parameters set and read by ARCHICAD

Curtain Wall Frame parameters

ac_frameWidth length

The width of the curtain wall frame.

Compatibility: introduced in ARCHICAD 22.

ac_frameDepth length

The depth of the curtain wall frame.

Compatibility: introduced in ARCHICAD 22.

ac_frameBackDepth length

The curtain wall frame's back offset from panel centerline.

Compatibility: introduced in ARCHICAD 22.

ac_clampWidth length

The width of the curtain wall panel insertion gap.

Compatibility: before ARCHICAD 22 this parameter could only be set by ARCHICAD.

ac_clampDepth length

The depth of the curtain wall panel insertion gap.

Compatibility: before ARCHICAD 22 this parameter could only be set by ARCHICAD.

Curtain Wall Parameters set by ARCHICAD

Curtain Wall Frame parameters

ac_nConnectingPanels length

The number of panels connecting to the frame. In case of boundary frames this value is 1, otherwise 2.

ac_clampVector[2][2] length, array

The direction vectors of the connecting curtain wall panels. The (ac_clampVector[1][1]; ac_clampVector[1][2]) vector contains the (X; Y) vector of the panel with the smaller rotation angle measured from local axis Y (counterclockwise, considering the positive direction of local axis X). In case of boundary frame the (ac_clampVector[2][1]; ac_clampVector[2][2]) vector contains the (X; Y) direction of the connecting panel, the other vector values are 0.

Curtain Wall Panel parameters

ac_panelCoords [[2]	length, array
<i>The X and Y coordinates of the curtain wall panel polygon measured on the insertion gap of the connecting frames in the local coordinate system. If such polygon does not exist, the first dimension of this parameter is set to 1, containing values 0, 0.</i>	
<i>Compatibility: invalid polygon geometry fallback to one node is introduced in ARCHICAD 22.</i>	
ac_clampFreeRegion [[2]	length, array
<i>The X and Y coordinates of the curtain wall panel polygon measured on the side of the connecting frames in the local coordinate system. If such polygon does not exist, the first dimension of this parameter is set to 1, containing values 0, 0.</i>	
<i>Compatibility: invalid polygon geometry fallback to one node is introduced in ARCHICAD 22.</i>	
ac_frameAxisCoords [[2]	length, array
<i>Compatibility: introduced in ARCHICAD 22.</i>	
<i>The X and Y coordinates of the curtain wall panel polygon measured on the axis of the connecting frames in the local coordinate system.</i>	

Curtain Wall Junction parameters

ac_frameDirs [[3]	length, array
<i>The end coordinates of the connecting curtain wall frame axes.</i>	
ac_panelOffsets []	length, array
<i>The clamp thicknesses of the connecting curtain wall panels.</i>	
<i>Note: total thickness of the panel for Built-in panels.</i>	
ac_panelPresences []	boolean, array
<i>Presence of the connecting curtain wall panels.</i>	

Curtain Wall Accessory parameters

ac_frameWidthLeft	length
<i>Reference frame contour width 1 (usually A/2)</i>	
ac_frameWidthRight	length
<i>Reference frame contour width 2 (usually A/2)</i>	

ac_frameWidthFront	length
<i>Reference frame contour length 1 (usually B/2)</i>	
ac_frameWidthBack	length
<i>Reference frame contour length 2 (usually B/2)</i>	
ac_accessoryFlipped	boolean
<i>Accessory flipped state. 0 - not flipped, 1 - flipped</i>	
ac_globalZDir[1][3]	length, array
<i>Vector of local Z axis in the global coordinate system</i>	
ac_cellAngle1	angle
<i>The accessory's frame can be connected to maximum 2 cells. These cells are cell1 and cell2. Cell1 is the cell with the smaller rotation angle measured from local axis Y (counterclockwise, considering the positive direction of local axis X). Parameter ac_cellAngle1 is the angle between cell1 and local axis Y.</i>	
ac_cellAngle2	angle
<i>The accessory's frame can be connected to maximum 2 cells. These cells are cell1 and cell2. Cell2 is the cell with the greater rotation angle measured from local axis Y (counterclockwise, considering the positive direction of local axis X). Parameter ac_cellAngle2 is the angle between cell2 and local axis Y.</i>	
ac_validCellAngle1	boolean
<i>Defines if there is cell 1 or not</i>	
ac_validCellAngle2	boolean
<i>Defines if there is cell 2 or not</i>	

Curtain Wall Frame Deprecated parameters

These parameters are still working in ARCHICAD's environment for compatibility reasons, but avoiding them is recommended during new object creation.

gs_rightOffset	length
<i>The distance of the curtain wall frame's inner side from the boundary. In case of Outside Boundary its value is the frame width, in case of Inside Boundary its value is 0.</i>	
gs_originOffsetX	length
<i>The distance of the curtain wall frame's outer side from the boundary. In case of Outside Boundary its value is 0, in case of Inside Boundary its value is the frame width.</i>	

gs_frontOffset	length
<i>The distance of the curtain wall frame's front side from the centerline of the panel.</i>	
gs_originOffsetY	length
<i>The distance of the curtain wall frame's back side from the centerline of the panel.</i>	
ac_topConnPlane[4]	length, array
<i>The top cutplane position of the frame, defined in the local coordinate system of the library part.</i>	
<i>ac_topConnPlane[1]: X component of the normal vector of top cutplane</i>	
<i>ac_topConnPlane[2]: Y component of the normal vector of top cutplane</i>	
<i>ac_topConnPlane[3]: Z component of the normal vector of top cutplane</i>	
<i>ac_topConnPlane[4]: distance of top cutplane from frame origo</i>	
ac_bottomConnplane[4]	length, array
<i>The bottom cutplane position of the frame, defined in the local coordinate system of the library part.</i>	
<i>ac_bottomConnplane[1]: X component of the normal vector of bottom cutplane</i>	
<i>ac_bottomConnplane[2]: Y component of the normal vector of bottom cutplane</i>	
<i>ac_bottomConnplane[3]: Z component of the normal vector of bottom cutplane</i>	
<i>ac_bottomConnplane[4]: distance of bottom cutplane from frame origo</i>	

Curtain Wall Parameters read by ARCHICAD

Curtain Wall Panel and Frame parameters

AC_AutoSchematicModel	boolean
<i>Controls whether the Schematic representation of the Curtain Wall Panel or Frame set at Model View Options / Curtain Wall Options is handled by ARCHICAD.</i>	
<i>Compatibility: introduced in ARCHICAD 22.</i>	

Curtain Wall Frame parameters

ac_iCWFrameType	integer
<p><i>Determines the type of frame</i></p> <ul style="list-style-type: none"> • 0 - Normal Frame • 1 - Diagonal Corner • 2 - Regular Double Corner • 3 - Regular Block Corner • 4 - Profiled Frame <p><i>The value of this parameter affects the Frame Type and Geometry Dialog and in case of the Regular Corner types, the Symbolic representation of the frame.</i></p> <p><i>Compatibility: introduced in ARCHICAD 22.</i></p>	
ac_bButtGlazedFrame	boolean
<p><i>Determines the type of frame</i></p> <ul style="list-style-type: none"> • 0 - frame with cap • 1 - butt-glazed frame <p><i>The value of this parameter affects the Frame Type and Geometry Dialog.</i></p> <p><i>Compatibility: introduced in ARCHICAD 22.</i></p>	
ac_capProfileID	profile
<p><i>Index of the selected profile used for the curtain wall frame cap. If this parameter and the ac_beamProfileID parameter exist in the curtain wall frame library part, the calculation of the frame and cap sizes is handled by ARCHICAD.</i></p> <p><i>Note: This parameter only has effect on ARCHICAD if the ac_beamProfileID parameter - see the section called "Stair related parameters" - exists.</i></p> <p><i>Compatibility: introduced in ARCHICAD 22.</i></p>	
ac_frameOffsetSide	length
<p><i>The distance of the frame side from the frame's origin measured on the panel centerline. The clamp depth is measured from this distance on the panel centerline.</i></p> <p><i>Compatibility: introduced in ARCHICAD 22.</i></p>	
ac_CWFrameBuildMat	building material
<p><i>The index of the frame's building material. The Symbolic representation of the frame is drawn with the fill attributes of this building material.</i></p> <p><i>Compatibility: introduced in ARCHICAD 22.</i></p>	

ac_CWFrameCutLinePen

pen

The index of the frame's cut line pen. The contour line of the Symbolic representation of the frame is drawn with the set pen index.

Compatibility: introduced in ARCHICAD 22.

ac_CWFrameCutLineType

linetype

The index of the frame's cut line type. The contour line of the Symbolic representation of the frame is drawn with the set line type index.

Compatibility: introduced in ARCHICAD 22.

Curtain wall panel parameters

ac_panel_type

integer

Determines the type of panel for listing. 0 - Fixed, 1 - Door, 2 - Window

ac_openingDir

integer

Determines the opening direction of doors and windows for listing. 0 - Fixed, 1 - Inside, 2 - Outside

ac_width

length

Panel width for listing.

ac_nominalWidth

length

Panel nominal width for listing.

ac_height

length

Panel height for listing.

ac_nominalHeight

length

Panel nominal height for listing.

ac_thickness

length

Panel thickness for listing.

ac_originIsFrameCenter

boolean

*If the parameter is present and its value is **true**, the panel origin is at the center point of the starting (left) frame. Otherwise, the origin is at the starting point of the left clamp.*

ac_aSizeIsWithClamp	boolean
----------------------------	---------

*If the parameter is present and its value is **true**, ARCHICAD sets the **A** size as the distance between the frames plus the clamps' size. Otherwise, the **A** size is measured between the frames.*

Parameters for add-ons

Add-ons can get values from library parts through parameters with predefined name and function. The list of such parameters related to ARCHICAD package add-ons follows below.

Parameters of Skylight add-on

Hole edge cut manipulation

ac_edge_lower_type	integer
---------------------------	---------

Cut type of the lower edge: 0 - Vertical, 1 - Perpendicular, 2 - Horizontal, 3 - Custom

ac_edge_lower_angle	angle
----------------------------	-------

*Angle of the cut of the lower edge, if **ac_edge_lower_type** is 3. The value range is [1-179] degrees, 90 is the perpendicular case.*

ac_edge_upper_type	integer
---------------------------	---------

Cut type of the upper edge: 0 - Vertical, 1 - Perpendicular, 2 - Horizontal, 3 - Custom

ac_edge_upper_angle	angle
----------------------------	-------

*Angle of the cut of the upper edge, if **ac_edge_upper_type** is 3. The value range is [1-179] degrees, 90 is the perpendicular case.*

Parameters of Corner Window add-on

Basic parameters of Corner Window objects

ac_cw_function	boolean
-----------------------	---------

Window place mode, controlled by the add-on. 0 - Window, 1 - Corner window

ac_corner_window	boolean
-------------------------	---------

Corner window mode selector, controlled by the object. 0 - Disable corner window mode, 1 - Enable corner window mode

ac_corner_angle	angle
<i>Angle between the connected walls.</i>	
ac_diff_con_wall_thk	boolean
<i>Always true (1). It is a historical feature showing whether the connected wall has a different thickness from the containing wall.</i>	
ac_con_wall_thk	length
<i>Thickness of the connected wall.</i>	
ac_cw_debug	boolean
<i>For internal usage only. Aspect of GDL programmers have no interest.</i>	

Wall skins data parameters of Corner Window objects (available from ARCHICAD 12)

ac_con_wall_skins_number	integer
<i>Number of skins in the connected wall. In case of solid walls it is zero.</i>	
ac_con_wall_skins_params	length
<i>Parameters of the connected composite wall skins. Same as the WALL_SKINS_PARAMS GDL global parameter of the owner wall.</i>	
ac_con_wall_direction_type	integer
<i>Connected wall flipped state; the flipped state of the wall, which means the adjustment of the wall body and the reference line: 0 - not flipped, 1 - flipped. (old meaning: 0 - Right, 1 - Left, 2 - Center (Right), 3 - Center (Left).)</i>	

Parameters of IFC add-on

Common basic parameters of Door and Window objects

ifc_LiningDepth	length
<i>Thickness of the door/window frame.</i>	
ifc_LiningThickness	length
<i>Width of the door/window frame.</i>	
ifc_TransomThickness	length
<i>Width of the transom.</i>	

IFC2x_ConstEnum integer / string

This parameter defines the basic types of construction of doors/windows.

<i>ifc_ConstEnum (integer) parameter value</i>	<i>IFC2x_ConstEnum (string) parameter value</i>	<i>IfcDoorStyleConstructionEnum category IfcWindowStyleConstructionEnum category</i>
0	<i>Not Defined</i>	NOTDEFINED
1	<i>Aluminum</i>	ALUMINIUM
2	<i>High Grade Steel</i>	HIGH_GRADE_STEEL
3	<i>Steel</i>	STEEL
4	<i>Wood</i>	WOOD
5	<i>Aluminum Wood</i>	ALUMINIUM_WOOD
6	<i>Aluminum Plastic</i>	ALUMINIUM_PLASTIC
7	<i>Plastic</i>	PLASTIC
8	<i>User Defined</i>	USERDEFINED

Basic parameters of Door objects

ifc_optype - Doors

integer / string

Door Opening Type, controlled by the IFC_optype_door.gsm macro.

ifc_optype (integer) parameter value	ifc_optypestr (string) parameter value	IfcDoorStyleOperationEnum category
0	<i>Not Defined</i>	NOTDEFINED
1	<i>Single Door Single Swing</i>	SINGLE_SWING_LEFT SINGLE_SWING_RIGHT
2	<i>Double Door Single Swing</i>	DOUBLE_DOOR_SINGLE_SWING
3	<i>Single Door Double Swing</i>	DOUBLE_SWING_LEFT DOUBLE_SWING_RIGHT
4	<i>Double Door Double Swing</i>	DOUBLE_DOOR_DOUBLE_SWING
5	<i>Double Door Single Swing Opposite</i>	DOUBLE_DOOR_SINGLE_SWING_OPPOSITE_LEFT DOUBLE_DOOR_SINGLE_SWING_OPPOSITE_RIGHT
6	<i>Single Door Sliding</i>	SLIDING_TO_LEFT SLIDING_TO_RIGHT
7	<i>Double Door Sliding</i>	DOUBLE_DOOR_SLIDING
8	<i>Single Door Folding</i>	FOLDING_TO_LEFT FOLDING_TO_RIGHT
9	<i>Double Door Folding</i>	DOUBLE_DOOR_FOLDING
10	<i>Revolving</i>	REVOLVING
11	<i>Rolling Up</i>	ROLLINGUP
12	<i>Other</i>	USERDEFINED
13	<i>Swing Fixed</i>	SWING_FIXED <i>Compatibility: introduced in ARCHICAD 23.</i>

ifc_LiningOffset

length

Offset of the door frame.

ifc_CasingDepth	length
<i>Thickness of the door casing.</i>	
ifc_CasingThickness	length
<i>Width of the door casing.</i>	
ifc_ThresholdDepth	length
<i>Depth of the door threshold.</i>	
ifc_ThresholdThickness	length
<i>Thickness of the door threshold.</i>	
ifc_ThresholdOffset	length
<i>Offset of the door threshold.</i>	
ifc_TransomOffset	length
<i>Offset of the transom.</i>	

ifc_DoorPanel

length - array

*ifc_DoorPanel[x][1] - thickness of the door sash.**ifc_DoorPanel[x][2] - width of the door sash.****ifc_DoorPanel[x][3] parameter value******IfcDoorPanelOperationEnum category***

0

NOTDEFINED

1

SWINGING

2

DOUBLE_ACTING

3

SLIDING

4

FOLDING

5

REVOLVING

6

ROLLINGUP

7

USERDEFINED

ifc_DoorPanel[x][4] parameter value***IfcDoorPanelPositionEnum category***

0

NOTDEFINED

1

LEFT

2

MIDDLE

3

RIGHT

Basic parameters of Window objects

ifc_optype - Windows	integer / string
<i>Window Opening Type, controlled by the IFC_optype_window.gsm macro.</i>	
<i>ifc_optype (integer)</i> <i>parameter value</i>	<i>ifc_optypestr (string)</i> <i>parameter values</i> <i>IfcWindowStyleOperationEnum category</i>
0	<i>Not Defined</i> NOTDEFINED
1	<i>Single</i> SINGLE_PANEL
2	<i>Double Vertical</i> DOUBLE_PANEL_VERTICAL
3	<i>Double Horizontal</i> DOUBLE_PANEL_HORIZONTAL
4	<i>Triple Vertical</i> TRIPLE_PANEL_VERTICAL
5	<i>Triple Horizontal</i> TRIPLE_PANEL_HORIZONTAL
6	<i>Triple Bottom</i> TRIPLE_PANEL_BOTTOM
7	<i>Triple Top</i> TRIPLE_PANEL_TOP
8	<i>Triple Left</i> TRIPLE_PANEL_LEFT
	<i>Triple Right</i> TRIPLE_PANEL_RIGHT
9	<i>Triple Right</i> TRIPLE_PANEL_RIGHT
10	<i>Other</i> USERDEFINED
ifc_MullionThickness	ifc_MullionThickness - length
<i>Width of the mullion.</i>	
ifc_FirstMullionOffset	ifc_FirstMullionOffset - length
<i>Offset of the mullion centerline.</i>	
ifc_SecondMullionOffset	ifc_SecondMullionOffset - length
<i>Offset of the mullion centerline of the second mullion.</i>	
ifc_FirstTransomOffset	ifc_FirstTransomOffset - length
<i>Offset of the transom centerline.</i>	

ifc_SecondTransomOffset

ifc_SecondTransomOffset - length

Offset of the transom centerline for the second mullion.

ifc_WindowPanel	length - array
<i>ifc_WindowPanel[x][1]</i> - thickness of the window sash.	
<i>ifc_WindowPanel[x][2]</i> - width of the window sash.	
<i>ifc_WindowPanel[x][3]</i> parameter value	<i>IfcWindowPanelOperationEnum</i> category
0	NOTDEFINED
1	SIDEHUNGRIGHTHAND
2	SIDEHUNGLFTHAND
3	TILTANDTURNRIGHTHAND
4	TILTANDTURNLEFTHAND
5	TOPHUNG
6	BOTTOMHUNG
7	PIVOTHORIZONTAL
8	PIVOTVERTICAL
9	SLIDINGHORIZONTAL
10	SLIDINGVERTICAL
11	REMOVABLECASEMENT
12	FIXEDCASEMENT
13	OTHEROPERATION
<i>ifc_WindowPanel[x][4]</i> parameter value	<i>IfcWindowPanelPositionEnum</i> category
0	NOTDEFINED
1	LEFT
2	MIDDLE
3	RIGHT
4	BOTTOM
5	TOP

Basic parameters of Transport Elements

ifc_optype - Transport Elements integer

Type choice for Transport Element. Compatibility: deprecated since ARCHICAD 23.

<i>ifc_optype (integer) parameter value</i>	<i>IfcTransportElementTypeEnum category</i>
0	NOTDEFINED
1	ELEVATOR
2	ESCALATOR
3	MOVINGWALKWAY
4	USERDEFINED

Basic parameters of Lift objects

ifc_CapacityByWeight realnum

Capacity of the transport element measured by weight. Compatibility: deprecated since ARCHICAD 23.

ifc_CapacityByNumber integer

Capacity of the transportation element measured in number of persons. Compatibility: deprecated since ARCHICAD 23.

Basic parameters of Stair objects

ifc_StairType	integer
<i>The basic configuration of the stair type in terms of the number of stair flights and the number of landings, controlled by the StairMaker add-on for the built-in stairs.</i>	
0	<i>Not Defined</i>
1	<i>StraightRunStair</i>
2	<i>TwoStraightRunStair</i>
3	<i>QuarterWindingStair</i>
4	<i>QuarterTurnStair</i>
5	<i>HalfWindingStair</i>
6	<i>HalfTurnStair</i>
7	<i>TwoQuarterWindingStair</i>
8	<i>TwoQuarterTurnStair</i>
9	<i>ThreeQuarterWindingStair</i>
10	<i>ThreeQuarterTurnStair</i>
11	<i>SpiralStair</i>
12	<i>DoubleReturnStair</i>
13	<i>CurvedRunStair</i>
14	<i>TwoCurvedRunStair</i>
15	<i>OtherOperation</i>
ifc_NumberOfRiser	integer
<i>Total number of risers in the stair.</i>	
ifc_NumberOfTreads	integer
<i>Total number of treads in the stair.</i>	
ifc_RiserHeight	length
<i>Vertical distance from tread to tread. The riser height is supposed to be equal for all steps of a stair or stair flight.</i>	

ifc_TreadLength

length

Horizontal distance from the front of the tread to the front of the next tread. The tread length is supposed to be equal for all steps of the stair or stair flight at the walking line.

Basic parameters of MEP elements

ifc_subtype	integer		
1 IfcAirTerminalBoxType	21 IfcHeatExchangerType	41 IfcElectricFlowStorageDeviceType	61 IfcUnitaryControlElementType
2 IfcAirTerminalType	22 IfcHumidifierType	42 IfcElectricGeneratorType	62 IfcBurnerType
3 IfcAirToAirHeatRecoveryType	23 IfcPipeFittingType	43 IfcSpaceHeaterType	63 IfcEngineType
4 IfcBoilerType	24 IfcPipeSegmentType	44 IfcElectricMotorType	64 IfcSolarDeviceType
5 IfcChillerType	25 IfcPumpType	45 IfcElectricTimeControlType	65 IfcElectricDistributionBoardType
6 IfcCoiType	26 IfcSpaceHeaterType	46 this value is skipped	66 IfcCableFittingType
7 IfcCompressorType	27 IfcTankType	47 IfcJunctionBoxType	67 IfcAudioVisualApplianceType
8 IfcCondenserType	28 IfcTubeBundleType	48 IfcLampType	68 IfcCommunicationsApplianceType
9 IfcCooledBeamType	29 IfcUnitaryEquipmentType	49 IfcLightFixtureType	69 IfcMedicalDeviceType
10 IfcCoolingTowerType	30 IfcValveType	50 IfcMotorConnectionType	70 IfcInterceptorType
11 IfcDamperType	31 IfcVibrationIsolatorType	51 IfcOutletType	
12 IfcDuctFittingType	32 IfcFireSuppressionTerminalType	52 IfcProtectiveDeviceType	
13 IfcDuctSegmentType	33 IfcSanitaryTerminalType	53 IfcSwitchingDeviceType	
14 IfcDuctSilencerType	34 IfcStackTerminalType	54 IfcTransformerType	
15 IfcEvaporativeCoolerType	35 IfcWasteTerminalType	55 IfcActuatorType	
16 IfcEvaporatorType	36 IfcCableCarrierFittingType	56 IfcAlarmType	
17 IfcFanType	37 IfcCableCarrierSegmentType	57 IfcControllerType	
18 IfcFilterType	38 IfcCableSegmentType	58 IfcFlowInstrumentType	
19 IfcFlowMeterType	39 IfcElectricApplianceType	59 IfcSensorType	
20 IfcSpaceHeaterType	40 this value is skipped	60 IfcProtectiveDeviceTrippingUnitType	

Compatibility: changes in ARCHICAD 23

- new types 60 to 70
- 20 IfcGasTerminalType renamed to IfcSpaceHeaterType
- 43 IfcElectricHeaterType renamed to IfcSpaceHeaterType

Parameters for Text Handling

Before ARCHICAD 22, selected Text Style controls were available for annotation tools (therefore library parts) spread on various settings dialog panels. Starting from ARCHICAD 22, a standard set of text handling controls became part of every annotation dialog in form of a dedicated "Text Style" panel.

Library parts belonging to such tools have access to these functions by using the following fix named optional parameters.

Starting from ARCHICAD 22, the locking/hiding of the corresponding ARCHICAD interface controls (if exist) is an option by using LOCK and HIDEPARAMETER commands via the parameter script of the library part, combined with "Enable hide/lock of specific fix named optional parameters" setting (see "Details/Compatibility Options" dialog of the object in the Library Part Editor).

For tool/version history, refer to the compatibility notes of each parameter.

By default, the following parameters are considered available and compatible before ARCHICAD 22, while exceptions are mentioned separately.

AC_TextFont_1	string
<i>Name of the currently selected/ stored Font Type.</i>	
<i>Compatibility: introduced in ARCHICAD 22 for Label objects. The similar global variable "LABEL_FONT_NAME" is considered deprecated since.</i>	
AC_TextSize_1	real
<i>Currently set/ stored Font Size value in mm.</i>	
<i>Compatibility: introduced in ARCHICAD 22 for Label and Zone objects. The similar global variable "LABEL_TEXT_SIZE" is considered deprecated in Labels. In Zone objects, the "ROOM_LSIZE" fix named optional parameter is also considered deprecated since.</i>	
AC_TextStyle_1	integer
<i>Font Style value mask. Can be used as direct input parameter for DEFINE STYLE{2} or UI_TEXTSTYLE_INFIELD.</i>	
values:	
<i>values = $j_1 + 2*j_2 + 4*j_3 + 128*j_8$, where each j can be 0 or 1.</i>	
<i>j_1: bold,</i>	
<i>j_2: italic,</i>	
<i>j_3: underline,</i>	
<i>j_8: strikethrough.</i>	
<i>If AC_TextStyle_1 = 0, then style is normal.</i>	
<i>Compatibility: introduced in ARCHICAD 22 for Zone and Label objects. The similar global variable "LABEL_FONT_STYLE2" is considered deprecated in Labels.</i>	

AC_TextPen_1	integer
---------------------	---------

Index of the currently selected/ stored Text Pen.

Compatibility: introduced in ARCHICAD 22 for Zone and Label objects. The similar global variable "LABEL_TEXT_PEN" is considered deprecated since in Labels.

The following set of text handling parameters are available for all annotation-type library parts. In Labels, the corresponding global variables are considered deprecated. See the section called “Deprecated Label Global Variables” for the full list of out-of-date label globals.

AC_TextAlignment_1	integer
---------------------------	---------

Alignment of the text.

1 - left aligned, 2 - center aligned, 3 - right aligned, 4 - full justified

Compatibility: introduced in ARCHICAD 22. In Labels, the similar global variable "LABEL_TEXT_ALIGN" is considered deprecated since ARCHICAD 22.

AC_TextLeading_1	real
-------------------------	------

Line spacing factor of the text.

Compatibility: introduced in ARCHICAD 22. In Labels, the similar global variable "LABEL_TEXT_LEADING" is considered deprecated since ARCHICAD 22.

AC_TextCharWidthFactor_1	real
---------------------------------	------

Character width factor of the text.

Compatibility: introduced in ARCHICAD 22. In Labels, the similar global variable "LABEL_TEXT_WIDTH_FACT" is considered deprecated since ARCHICAD 22.

AC_TextCharSpaceFactor_1	real
---------------------------------	------

Character spacing factor of the text.

Compatibility: introduced in ARCHICAD 22. In Labels, the similar global variable "LABEL_TEXT_CHARSPEACE_FACT" is considered deprecated since ARCHICAD 22.

Parameters for Labels

Parameters set or read by ARCHICAD

The following set of label parameters were all introduced in ARCHICAD 22, so the parallel global variables are considered deprecated. See the section called “Deprecated Label Global Variables” for the full list of out-of-date label globals.

Starting from ARCHICAD 22, the locking/hiding of the corresponding ARCHICAD interface controls (if exist) is an option by using LOCK and HIDEPARAMETER commands via the parameter script of the library part, combined with "Enable hide/lock of specific fix named optional parameters" setting (see "Details/Compatibility Options" dialog of the object in the Library Part Editor).

AC_bLabelAlwaysReadable	Boolean
<i>1 - "Always Readable" is checked on "Label Settings/Text Style" panel, 0 otherwise</i>	
<i>Compatibility: introduced in ARCHICAD 22. The similar global variable "LABEL_ALWAYS_READABLE" is considered deprecated since ARCHICAD 22.</i>	
AC_bLabelTextWrap	Boolean
<i>1 - "Wrap Text" is checked on "Label Settings/Text Style" panel, 0 otherwise</i>	
<i>Compatibility: introduced in ARCHICAD 22. The similar global variable "LABEL_TEXT_WRAP" is considered deprecated since ARCHICAD 22.</i>	
AC_bLabelOpaqueFill	Boolean
<i>1 - "Opaque" is checked on "Label Settings/Text Style" panel, 0 otherwise</i>	
<i>Compatibility: introduced in ARCHICAD 22. The similar global variable "LABEL_TEXT_BG_PEN" is considered deprecated since ARCHICAD 22.</i>	
AC_LabelTextBgrPen	integer
<i>Contains the index of the selected Text Fill Pen.</i>	
<i>Compatibility: introduced in ARCHICAD 22. The similar global variable "LABEL_TEXT_BG_PEN" is considered deprecated since ARCHICAD 22.</i>	
AC_bLabelFrame	Boolean
<i>1 - "Frame" is checked, 0 - "Frame" is unchecked.</i>	
<i>Compatibility: introduced in ARCHICAD 22. The similar global variable "LABEL_FRAME_ON" is considered deprecated since ARCHICAD 22.</i>	
AC_LabelFrameOffset	length
<i>Frame offset value according to "Label Settings/Text Style" panel.</i>	
<i>Compatibility: introduced in ARCHICAD 22. The similar global variable "LABEL_FRAME_OFFSET" is considered deprecated since ARCHICAD 22.</i>	
AC_LabelPointerPen	pen
<i>Contains the index of the selected Pointer Line Pen.</i>	
<i>Compatibility: introduced in ARCHICAD 22. The similar global variable "LABEL_ARROW_PEN" is considered deprecated since ARCHICAD 22.</i>	
AC_LabelPointerLineType	line type
<i>Contains the index of the selected Pointer Line Type.</i>	
<i>Compatibility: introduced in ARCHICAD 22. The similar global variable "LABEL_ARROW_LINETYPE" is considered deprecated since ARCHICAD 22.</i>	

AC_LabelPointerConnection integer

Pointer connection position.

0 - middle, 1 - top, 2 - bottom, 3 - bottom right

Compatibility: introduced in ARCHICAD 22. The similar global variable "LABEL_ANCHOR_POS" is considered deprecated since ARCHICAD 22.

AC_LabelOrientation integer

Label orientation type value of "Label Orientation" settings in "Symbol Label" panel. "LABEL_ROTANGLE" value may change according to orientation settings.

1 - parallel, 2 - perpendicular, 3 - vertical, 4 - horizontal, 5 - custom angle

Compatibility: introduced in ARCHICAD 22.

Extended LOCK/HIDEPARAMETER feature is not available for this parameter. Masking of the corresponding interface control values is set by "AC_DisableLabelOrientationVal". The parameter defines the library part default value.

Parameters read by ARCHICAD

AC_DisableLabelOrientationVal integer

Label orientation ("AC_LabelOrientation") type value mask.

bitset: *Disable the following options in "Symbol Label" dialog panel for "Label Orientation":*

*bitset = $j_1 + 2*j_2 + 4*j_3 + 8*j_4$, where each j can be 0 or 1.*

j_1 : "Parallel",

j_2 : "Perpendicular",

j_3 : "Vertical",

j_4 : "Horizontal".

"Custom" type cannot be disabled.

Compatibility: introduced in ARCHICAD 22.

ac_bDisableLabelFrameDisplay boolean

Compatibility: introduced in ARCHICAD 20.

Hides the built-in rectangular frame drawing around the Label Symbol in case of the built-in Pointer and Frame is set, enabling the user to script custom shaped frame.

ac_bCustomPointerConnection boolean

Compatibility: introduced in ARCHICAD 20.

Controls the automatic Pointer Connections of the Label Symbol in case of the built-in Pointer is set. If this parameter is set to ON, 6 hotspots can be defined in the 2D script for the custom pointer connection in accordance with the built-in types. These hotspots should have fix ID-s from 1 to 6. The ID's indicate the following connection positions:

If the Pointer is on the left side of the Label Symbol:

- 1: left top connection
- 3: left middle connection
- 5: left bottom connection
- 6: right bottom connection

If the Pointer is on the right side of the Label Symbol:



- 2: right top connection
 - 4: right middle connection
 - 6: right bottom connection
 - 5: left bottom connection
-

Deprecated parameters

Deprecated Beam/Column parameters - available for listing and labels only



From ARCHICAD 23 these values are available in BEAM_SEGMENT_INFO and COLU_SEGMENT_INFO global variables with uniformized value references. See also the section called “Deprecated Beam/Column Global Variables - available for listing and labels only”. For compatibility, they are still available on homogeneous, straight or horizontally curved Beams and on homogeneous Columns (GLOB_ELEM_TYPE = 12 or 6).

ac_colu_crosssection_type cross-section type of the column (integer)

 <i>Column Segment (27)</i>	 <i>Single-segment Column (6)</i>	 <i>Multi-segment Column (6)</i>
--	--	---

1 - rectangular, 2 - round, 3 - complex profiled

ac_beam_crosssection_type cross-section type of the beam (integer)

 <i>Beam Segment (28)</i>	 <i>Single-segment Beam (12)</i>	 <i>Multi-segment Beam (12)</i>
--	---	--

1 - rectangular, 2 - complex profiled

Deprecated Zone Stamp parameters

ROOM_LSIZE	real
<i>Font size of text in mm.</i>	
<i>Compatibility: deprecated since ARCHICAD 22. Use AC_TextSize_1 instead.</i>	
ac_disable_controls	integer
<i>This parameter can control the visibility of the Font Size ("ROOM_LSIZE") input area of the Zone Stamp settings dialog: 0 or the object doesn't have the parameter - show Font Size, 1 - hide Font Size (therefore allowing extra space for the parameter list)</i>	
<i>Compatibility: inactive since ARCHICAD 22. The "Font Size" input control has moved to the "Text Style" panel, its visibility is controlled by LOCK/HIDEPARAMETER commands.</i>	

REQUEST OPTIONS

n = **REQUEST** (question_name, name_or_index, variable1 [, variable2, ...])
n = **REQUEST{2}** (question_name, name_or_index, name, variable1 [, variable2, ...])
n = **REQUEST{3}** (question_name, name, name_or_index_array, variable1 [, variable2, ...])
n = **REQUEST{4}** (question_name, name_or_index, index, name, variable1 [, variable2, ...])

The first parameter represents the question string while the second (or more) represents the object of the question (if it exists). The other parameters are variable names in which the return values (the answers) are stored. The function's return value is the number of the answer (in the case of a badly formulated question or a nonexistent name, the value will be 0).

ARCHICAD identifies the order and number of the input parameters by either the version of the REQUEST command, or the exact name (as string constant) of the request option. This means that using the first or both of the following options is the safest:

- name of the request is always a constant string
- version is added to the command

Request Parameter Script Compatibility

The use of most requests in parameter scripts (or master scripts run as parameter script) can result in unstable returned values, therefore should be avoided.

Compatibility up to ARCHICAD 19: The use of most requests in parameter scripts (or master scripts run as parameter script) could result in unreliable returned values.



Compatibility starting from ARCHICAD 20: the following applies in parameter script cases:

























- *the request expression will always have 0 as success return value*
- *the requested values will contain a type-matching default only (empty string or 0)*



Using restricted requests in the parameter script will also generate GDL warnings starting from ARCHICAD 19.

To check the parameter script compatibility, refer to the tables below:

Legend:

	works without restriction
	works (with additional warning)
	does not work: expression returns 0, while containing dummy type-matching defaults in returned variables (empty string or 0) - with additional warning

Compatibility in Parameter Script	ARCHICAD 18	ARCHICAD 19	ARCHICAD 20
ANCESTRY_INFO			
ANGULAR_DIMENSION			
ANGULAR_LENGTH_DIMENSION			
AREA_DIMENSION			
ASSOCEL_PROPERTIES			
ASSOCLP_NAME			
ASSOCLP_PARVALUE			
ASSOCLP_PARVALUE_WITH_DESCRIPTION			
AUTOTEXT_LIST	-	-	

Compatibility in Parameter Script	ARCHICAD 18	ARCHICAD 19	ARCHICAD 20
BUILDING_MATERIAL_INFO			

Compatibility in Parameter Script	ARCHICAD 18	ARCHICAD 19	ARCHICAD 20
CALC_ANGLE_UNIT	✓	⚠	✗
CALC_AREA_UNIT	✓	⚠	✗
CALC_LENGTH_UNIT	✓	✓	✓
CALC_VOLUME_UNIT	✓	✓	✓
CLASS_OF_FILL	✓	✓	✓
CLEAN_INTERSECTIONS	✓	⚠	✗
COMPONENT_PROJECTED_AREA	✓	⚠	✗
COMPONENT_VOLUME	✓	⚠	✗
CONFIGURATION_NUMBER	-	-	✗
CONSTR_FILLS_DISPLAY	✓	⚠	✗
CUSTOM_AUTO_LABEL	✓	⚠	✗

Compatibility in Parameter Script	ARCHICAD 18	ARCHICAD 19	ARCHICAD 20
DATETIME	✓	⚠	⚠
DOOR_SHOW_DIM	✓	⚠	✗

Compatibility in Parameter Script	ARCHICAD 18	ARCHICAD 19	ARCHICAD 20
ELEVATION_DIMENSION	✓	⚠	✗

Compatibility in Parameter Script	ARCHICAD 18	ARCHICAD 19	ARCHICAD 20
FLOOR_PLAN_OPTION	✓	⚠	✗
FONTNAMES_LIST	✓	✓	✓
FULL_ID_OF_PARENT	-	⚠	✗

Compatibility in Parameter Script	ARCHICAD 18	ARCHICAD 19	ARCHICAD 20
HEIGHT_OF_STYLE	✓	✓	✓
HOME_STORY	✓	✓	✓
HOME_STORY_OF_OPENING	✓	✓	✓
HOMEDB_INFO	✓	✓	✓

Compatibility in Parameter Script	ARCHICAD 18	ARCHICAD 19	ARCHICAD 20
ID_OF_MAIN	✓	⚠	✗
INTERNAL_ID	✓	✓	✓

Compatibility in Parameter Script	ARCHICAD 18	ARCHICAD 19	ARCHICAD 20
LAYOUT_LENGTH_UNIT	✓	⚠	⚠
LAYOUT_TEXT_SIZE_UNIT	✓	✓	✓
LEVEL_DIMENSION	✓	⚠	✗
LINEAR_DIMENSION	✓	✓	✓

Compatibility in Parameter Script	ARCHICAD 18	ARCHICAD 19	ARCHICAD 20
MATCHING_PROPERTIES	✓	⚠	✗
MATERIAL_INFO	✓	⚠	✗
MODEL_LENGTH_UNIT	✓	⚠	⚠
MODEL_TEXT_SIZE_UNIT	✓	⚠	✗

Compatibility in Parameter Script	ARCHICAD 18	ARCHICAD 19	ARCHICAD 20
NAME_OF_FILL	✓	⚠	✗
NAME_OF_LINE_TYPE	✓	⚠	✗
NAME_OF_LISTED	✓	⚠	✗
NAME_OF_MACRO	✓	✓	✓
NAME_OF_MAIN	✓	✓	✓
NAME_OF_MATERIAL	✓	⚠	✗
NAME_OF_PLAN	✓	⚠	✗
NAME_OF_PROGRAM	✓	⚠	✗
NAME_OF_STYLE	✓	⚠	✗

Compatibility in Parameter Script	ARCHICAD 18	ARCHICAD 19	ARCHICAD 20
PEN_OF_RGB	✓	⚠	✗
PROGRAM_INFO	✓	✓	✓
PROPERTIES_OF_PARENT	-	-	✗
PROPERTY_NAME	-	-	✗
PROPERTY_VALUE_OF_PARENT	-	-	✗

Compatibility in Parameter Script	ARCHICAD 18	ARCHICAD 19	ARCHICAD 20
RADIAL_DIMENSION	✓	⚠	✗
REFERENCE_LEVEL_DATA	✓	✓	✓
RGB_OF_MATERIAL	✓	⚠	✗
RGB_OF_PEN	✓	⚠	✗

Compatibility in Parameter Script	ARCHICAD 18	ARCHICAD 19	ARCHICAD 20
SILL_HEIGHT_DIMENSION	✓	✓	✓
STORY	✓	⚠	✗
STORY_INFO	✓	✓	✓
STYLE_INFO	✓	⚠	⚠
SUM_WITH_ROUNDING	-	-	✓

Compatibility in Parameter Script	ARCHICAD 18	ARCHICAD 19	ARCHICAD 20
TEXTBLOCK_INFO	✓	⚠	✗

Compatibility in Parameter Script	ARCHICAD 18	ARCHICAD 19	ARCHICAD 20
VIEW_ROTANGLE	✓	✓	✓
WINDOW_DOOR_DIMENSION	✓	✓	✓
WINDOW_DOOR_SHOW_DIM	✓	⚠	✗
WINDOW_DOOR_ZONE_RELEV	✓	⚠	⚠
WINDOW_DOOR_ZONE_RELEV_OF_OWNER	✓	⚠	⚠
WINDOW_SHOW_DIM	✓	⚠	✗
WORKING_ANGLE_UNIT	✓	⚠	⚠
WORKING_LENGTH_UNIT	✓	✓	✓

Compatibility in Parameter Script	ARCHICAD 18	ARCHICAD 19	ARCHICAD 20
ZONE_CATEGORY	✓	✓	✓
ZONE_COLUS_AREA	✓	⚠	✗
ZONE_RELATIONS	✓	✓	✓
ZONE_RELATIONS_OF_OWNER	✓	⚠	⚠

Details of Requests

`n = REQUEST ("Name_of_program", "", program_name)`

Returns in the given variable the name of the program, e.g., "ARCHICAD". *Expression returns 0 and contains dummy return values (empty string or 0) if used in parameter script, causing additional warning.*

Example 1: Printing the name of the program

```
n = REQUEST ("Name_of_program", "", program_name)
PRINT program_name
```

```
n = REQUEST ("Name_of_macro", "", my_name)
n = REQUEST ("Name_of_main", "", main_name)
```

After executing these function calls, the my_name variable will contain the name of the macro, while main_name will contain the name of the main macro (if it doesn't exist, empty string).

```
n = REQUEST ("ID_of_main", "", id_string)
```

For library parts placed on the floor plan, returns the identifier set in the tool's settings dialog box in the id_string variable (otherwise empty string). Not working on annotation elements (e.g. Label, D/W Marker, Zone Stamp). *Expression returns 0 and contains dummy return values (empty string or 0) if used in parameter script, causing additional warning.*

```
n = REQUEST ("Full_ID_of_parent", "", id_string)
```

For annotation elements linked or hotlinked on the floor plan, returns all identifiers (Master ID) of the linked modules and the parent library parts' identifier set in the tool's settings dialog box in the id_string variable (otherwise empty string). *Expression returns 0 and contains dummy return values (empty string or 0) if used in parameter script, causing additional warning.*

```
n = REQUEST ("Name_of_plan", "", name)
```

Returns in the given variable the name of the current project. *Expression returns 0 and contains dummy return values (empty string or 0) if used in parameter script, causing additional warning.*

```
n = REQUEST ("Story", "", index, story_name)
```

Returns in the index and story_name variables the index and the name of the current story. *Expression returns 0 and contains dummy return values (empty string or 0) if used in parameter script, causing additional warning.*

```
n = REQUEST ("Home_story", "", index, story_name)
```

Returns in the index and story_name variables the index and the name of the home story.

```
n = REQUEST ("Home_story_of_opening", "", index, story_name)
```

Returns the index and the name of the home story of the opening in the index and story_name variables. The home story is the first story, where the opening is visible. Can be used in scripts of doors, windows, wallends, corner windows and skylights, and in the script of their labels and markers. Causes warning if used in parameter script.

```
n = REQUEST ("Story_info", expr, nStories,
             index1, name1, elev1, height1 [,
             index2, name2, ...])
```

Returns the story information in the given variables: number of stories and story index, name, elevation, height to next successively. If expr is a numerical expression, it means a story index: only the number of stories and the information on the specified story is returned. If expr is a string expression, it means that information on all stories is requested. The return value of the function is the number of successfully retrieved values.

Example 2:

```
DIM t[]
n = REQUEST ("STORY_INFO", "", nr, t)
FOR i = 1 TO nr
  nr = STR ("%0m", t [4 * (i - 1) + 1])
  name = t [4 * (i - 1) + 2]
  elevation = STR ("%m", t [4 * (i - 1) + 3])
  height = STR ("%m", t [4 * (i - 1) + 4])
  TEXT2 0, -i, nr + ", " + name + ", " + elevation + ", " + height
NEXT i
```

With the following requests, you can learn the dimension formats set in the Options/Project Preferences/Dimensions and Calculation Units & Rules dialog boxes. These requests return a format string that can be used as the first parameter in the STR () function.

```
n = REQUEST ("Linear_dimension", "", format_string)
n = REQUEST ("Angular_dimension", "", format_string)
```

Expression returns 0 and contains dummy return values (empty string or 0) if used in parameter script, causing additional warning.

```
n = REQUEST ("Angular_length_dimension", "", format_string)
```

Expression returns 0 and contains dummy return values (empty string or 0) if used in parameter script, causing additional warning.

```
n = REQUEST ("Radial_dimension", "", format_string)
```

Causes warning if used in parameter script.

```
n = REQUEST ("Level_dimension", "", format_string)
```

Causes warning if used in parameter script.

```
n = REQUEST ("Elevation_dimension", "", format_string)
```

Expression returns 0 and contains dummy return values (empty string or 0) if used in parameter script, causing additional warning.

```
n = REQUEST ("Window_door_dimension", "", format_string)
```

```
n = REQUEST ("Sill_height_dimension", "", format_string)
```

```
n = REQUEST ("Area_dimension", "", format_string)
n = REQUEST ("Calc_length_unit", "", format_string)
n = REQUEST ("Calc_area_unit", "", format_string)
```

Expression returns 0 and contains dummy return values (empty string or 0) if used in parameter script, causing additional warning.

```
n = REQUEST ("Calc_volume_unit", "", format_string)
n = REQUEST ("Calc_angle_unit", "", format_string)
```

Expression returns 0 and contains dummy return values (empty string or 0) if used in parameter script, causing additional warning.

Example 3:

```
format = "" num = 60.55
n = REQUEST ("Angular_dimension", "", format)!"%.2dd"
TEXT2 0, 0, STR (format, num)!60.55
```

```
n = REQUEST ("Clean_intersections", "", state)
```

Returns the state of the Clean Wall & Beam Intersections feature (1 when turned on, 0 when off) *Expression returns 0 and contains dummy return values (empty string or 0) if used in parameter script, causing additional warning.*

```
n = REQUEST ("Zone_category", "", name, code)
```

For zones, returns the name and the code string of the current zone category.

```
n = REQUEST ("Zone_relations", "",
             category_name, code, name, number
             [, category_name2, code2, name2, number2])
```

Returns in the given variables the zone category name and code and the name and number of the zone where the library part containing this request is located. For doors and windows, there can be a maximum of two zones. The return value of the request is the number of successfully retrieved values (0 if the library part is not inside any zone).

```
n = REQUEST ("Zone_relations_of_owner", "",
             category_name, code, name, number
             [, category_name2, code2, name2, number2])
```

Returns in the given variables the category name & code and the zone name & number of the zone where the owner of the object is located. So, it is meaningful, if the library part has owner (door-window labels and door-window markers, etc.). In case of a door label, its owner is the door. For doors and windows, there can be a maximum of two related zones. The return value of the request is the number of successfully retrieved values (0 if the object has no owner, or its owner is not inside any zone). Causes warning if used in parameter script.

```
n = REQUEST ("Zone_colus_area", "", area)
```

Returns in the area variable the total area of the columns placed in the current zone. Effective only for Zone Stamps. Available only for compatibility reasons. It is recommended to use quantities set in Zone Stamp fix parameters. *Expression returns 0 and contains dummy return values (empty string or 0) if used in parameter script, causing additional warning.*

n = REQUEST ("Custom_auto_label", "", name)

Returns in the name variable the name of the custom auto label of the library part or an empty string if it does not exist. *Expression returns 0 and contains dummy return values (empty string or 0) if used in parameter script, causing additional warning.*

n = REQUEST ("Rgb_of_material", name, r, g, b)

n = REQUEST ("Rgb_of_pen", penindex, r, g, b)

n = REQUEST ("Pen_of_RGB", "r g b", penindex)

Like the REQ() function (but in just one call), returns in the specified variables the value of the r, g, b components of the material and pen, or the index of the pen corresponding to the given RGB values. *All 3 expressions return 0 containing dummy return values (empty string or 0) if used in parameter script, causing additional warning.*

n = REQUEST ("Height_of_style", name, height [, descent, leading])

Returns in the given variables the total height of the style measured in millimeters (height in meters is height / 1000 * GLOB_SCALE); the descent (the distance in millimeters from the text base line to the descent line) and the leading (the distance in millimeters from the descent line to the ascent line).

n = REQUEST ("Style_info", name, fontname [, size, anchor, face_or_slant])

Returns information in the given variables on the previously defined style (*see style parameters at the DEFINE STYLE command*). Can be useful in macros to collect information on the style defined in a main script. Causes warning if used in parameter script.

n = REQUEST ("Name_of_material", index, name)

Returns in the variable the material name identified by index. *Expression returns 0 and contains dummy return values (empty string or 0) if used in parameter script, causing additional warning.*

n = REQUEST ("Name_of_building_material", index, name)

Returns in the variable the building material name identified by index. *Expression returns 0 and contains dummy return values (empty string or 0) if used in parameter script, causing additional warning.*

n = REQUEST ("Name_of_fill", index, name)

Returns in the name variable the fill name identified by index. *Expression returns 0 and contains dummy return values (empty string or 0) if used in parameter script, causing additional warning.*

n = REQUEST ("Name_of_line_type", index, name)

Returns in the given variable the line name identified by index. *Expression returns 0 and contains dummy return values (empty string or 0) if used in parameter script, causing additional warning.*

n = REQUEST ("Name_of_style", index, name)

Returns in the given variable the name of the style identified by index. *Expression returns 0 and contains dummy return values (empty string or 0) if used in parameter script, causing additional warning.*

If index < 0, it refers to a material, fill, line type or style defined in the GDL script or the MASTER_GDL file. A call of a request with index = 0 returns in the variable the name of the default material or line type. (Empty string for fill and style.)

The return value of the request is the number of successfully retrieved values (1 if no error occurred, 0 for error when the index is not valid).

n = REQUEST ("WINDOW_DOOR_SHOW_DIM", "", show)

Before 9.0 returns 1 in the show variable if Options/Display Options/Doors & Windows is set to "Show with Dimensions", 0 otherwise. Since 9.0 display options were split to separate Door and Window display options, so for compatibility reasons ARCHICAD checks if the request is used in a Window (or marker of a Window) or a Door (or marker of a Door) and automatically returns the corresponding display option. In other cases (symbol, lamp, label) the Window option is returned. Can be used to hide/show custom dimensions according to the current Display Options. *Expression returns 0 and contains dummy return values (empty string or 0) if used in parameter script, causing additional warning.*

Since 9.0 the "window_show_dim", and the "door_show_dim" separate requests are available.

n = REQUEST ("window_show_dim", "", show)

Returns 1 in the show variable if in the Model View Options/Window options the "with Markers" is checked, 0 otherwise. *Expression returns 0 and contains dummy return values (empty string or 0) if used in parameter script, causing additional warning.*

n = REQUEST ("door_show_dim", "", show)

Returns 1 in the show variable if in the Model View Options/Door options the "with Markers" is checked, 0 otherwise. *Expression returns 0 and contains dummy return values (empty string or 0) if used in parameter script, causing additional warning.*

n = REQUEST ("name_of_listed", "", name)

Returns in the name variable the name of the library part associated with the property type library part containing this request. For elements (Walls, Slabs, etc.), the name is an empty string. Causes warning if used in parameter script.

n = REQUEST ("window_door_zone_relev", "", out_direction)

Effective only for Doors and Windows. Use it as complement to the "zone_relations" request. Returns 1 in the out_direction variable if the Door/Window opening direction is in that of the first room identified by the "zone_relations" request, 2 if the opening direction is towards the second room. It also returns 2 if there is only one room and the opening direction is to the outside. Causes warning if used in parameter script.

n = REQUEST ("window_door_zone_relev_of_owner", "", out_direction)

Effective only if the library part's parent is a door or a window (markers, labels). Use it as a complement to the "zone_relations_of_owner" request. Returns 1 in the out_direction variable if the parent's opening direction is in that of the first zone identified by the zone relations type requests, 2 if the opening direction is towards the second zone. It also returns 2 if there is only one zone and the opening direction is to the outside. Causes warning if used in parameter script.

```
n = REQUEST ("matching_properties", type, name1, name2, ...)
```

If type = 1, returns in the given variables individually associated property library part names, otherwise property library part names associated by criteria. If used in an associative label, the function returns the properties of the element the label is associated with. *Expression returns 0 and contains dummy return values (empty string or 0) if used in parameter script, causing additional warning.*

```
n = REQUEST ("Working_length_unit", "", format_string)
```

```
n = REQUEST ("Working_angle_unit", "", format_string)
```

With these requests, the user can get the working unit formats as set in the Options > Project Preferences > Working Units dialog box. They return a format string that can be used as the first parameter in the STR () function. The requests both work when interpreting the user interface script, but "Working_angle_unit" causes warning if used in parameter script.

```
n = REQUEST ("Model_length_unit", "", format_string)
```

```
n = REQUEST ("Layout_length_unit", "", format_string)
```

With these requests, the user can get the layout and the model unit formats as set in the Options > Project Preferences > Working Units dialog box. They return a format string that can be used as the first parameter in the STR () function. *Both expressions return 0 containing dummy return values (empty string or 0) if used in parameter script, causing additional warning. Both work in User Interface Script only.*

```
n = REQUEST ("Model_text_size_unit", "", format_string)
```

```
n = REQUEST ("Layout_text_size_unit", "", format_string)
```

With these requests, the user can get the layout and the model text size formats. They return a format string that can be used as the first parameter in the STR () function. The requests cause warning if used in parameter script.

```
n = REQUEST ("Properties_Of_Parent", propertyType, parentProperties)
```

Returns the properties of the parent object. All properties are returned in one array with the following form: ID, type, group, name. Can be used only in labels. *Expression returns 0 and contains dummy return values (empty string or 0) if used in parameter script, causing additional warning.*

Core property:	[id, "", "", PropertyName]
AC property:	[guid, "", "GroupName", PropertyName]
IFC property:	[id, "IFC", "GroupName", PropertyName]
Classification:	[guid, "Classification", "", ClassificationSystemName]
Profile parameter:	[guid, "", "Profile Parameters", ParameterName]

propertyType: keyword defining the type of the requested properties. Empty string retruns all types of properties. Possible values:

```
"COREPROPERTY"
```

```
"ACPROPERTY"
```

```
"IFCPROPERTY"
```

```
"CLASSIFICATION"
```

```
"PROFILEPARAMETER"
```

Compatibility: the request is introduced in ARCHICAD 20. The property type options and the Classification property type are introduced in ARCHICAD 21, the Profile parameter property type is introduced in ARCHICAD 22.

Example 4:

```
DIM parentProperties[]
n = REQUEST ("Properties Of Parent", "", parentProperties)
! parentProperties = [Id1, TypeName1, GroupName1, PropertyName1,
                    Id2, TypeName2, GroupName2, PropertyName2,
                    ...
                    Idn, TypeNamen, GroupNamen, PropertyNamen]
```

```
n = REQUEST ("Property_Value_Of_Parent", "id", type, dim1, dim2, propertyValues)
```

Returns value array of the selected property. Can be used only in labels. *Expression returns 0 and contains dummy return values (empty string or 0) if used in parameter script, causing additional warning.*

Compatibility: introduced in ARCHICAD 20.

id: the ID of the selected property (string).

type: the type of the selected property value.

- 1: boolean
- 2: integer
- 3: real number
- 4: string
- 5: length
- 6: area
- 7: volume
- 8: angle

Compatibility: length, area, volume and angle types are introduced in ARCHICAD 22.

dim1, dim2: the dimensions of the **propertyValues** array.

- dim1 = 0, dim2 = 0: simple, scalar value.
- dim1 > 0, dim2 > 0: list of values.

Example 5:

```
DIM propertyValues[]
n = REQUEST ("Property_Value_Of_Parent", "ExampleId", type, dim1, dim2, propertyValues)
```

n = REQUEST ("Property_Values_Of_Parent", propInputIds, propOutputVals)

Returns a value dictionary for the given property ID dictionary. Can be used only in labels. *Expression returns 0 and contains dummy return values (empty string or 0) if used in parameter script or used with unknown input dictionary key, causing additional warning.*

Compatibility: introduced in ARCHICAD 23.

propInputIds: (dictionary) defining the selected property IDs.

propInputIds.propertyIds[n]: (array) contains a dictionary for each selected property ID.

propInputIds.propertyIds[n].id: (string) the ID of the selected property.

propOutputVals: (dictionary) the property value data for the selected property IDs.

propOutputVals.propertyValues[n]: (array) contains dictionaries for each property value.

propOutputVals.propertyValues[n].value_status: the status of the selected property value

- 1: the selected property is available and has value
- 2: the selected property is available but no value has been defined for it
- 3: the property is unavailable, or the selected ID is not valid
- 4: the property value cannot be evaluated

propOutputVals.propertyValues[n].type: the type of the selected property value. This key only exists in case the propOutputVals.propertyValues[n].value_status is 1 or 2.

- 1: boolean
- 2: integer
- 3: real number
- 4: string
- 5: length
- 6: area
- 7: volume
- 8: angle

propOutputVals.propertyValues[n].value[]: (array) contains the list of the selected property values.

Example 6:

```
dict propInputIds
  propInputIds.propertyIds[1].id = "ExampleId1"
  propInputIds.propertyIds[2].id = "ExampleId2"
  ...
  propInputIds.propertyIds[n].id = "ExampleIdn"
dict propOutputVals
n = REQUEST ("Property_Values_Of_Parent", propInputIds, propOutputVals)
! propOutputVals
  .propertyValues[1].value_status
  .propertyValues[1].type
  .propertyValues[1].value[]
  .propertyValues[2].value_status
  .propertyValues[2].type
  .propertyValues[2].value[]
  ...
  .propertyValues[n].value_status
  .propertyValues[n].type
  .propertyValues[n].value[]
```

```
n = REQUEST ("Component_Properties_Of_Parent", propertyType, parentComponentProperties)
```

Returns the component properties, which are available for at least one of the building material components of the parent object. All properties are returned in one array with the following form: ID, type, group, name. Can be used only in labels. *Expression returns 0 and contains dummy return values (empty string or 0) if used in parameter script, causing additional warning.*

```
AC property: [guid, "", "GroupName", PropertyName]
Classification: [guid, "Classification", "", ClassificationSystemName]
```

propertyType: keyword defining the type of the requested properties. Empty string returns all available types of properties. Possible values:
 "ACPROPERTY"
 "CLASSIFICATION"

Compatibility: the request is introduced in ARCHICAD 23.

Example 7:

```
DIM parentComponentProperties[]
n = REQUEST ("Component_Properties_Of_Parent", "", parentComponentProperties)
! parentComponentProperties = [Id1, TypeName1, GroupName1, PropertyName1,
                             Id2, TypeName2, GroupName2, PropertyName2,
                             ...
                             Idn, TypeNamen, GroupNamen, PropertyNamen]
```

```
n = REQUEST ("Component_IDS_Of_Parent", collectComponents, outputCompIds)
```

Returns the building material component IDs of the parent object in a dictionary form. Can be used only in labels. *Expression returns 0 and contains dummy return values (empty string or 0) if used in parameter script, causing additional warning.*

Compatibility: introduced in ARCHICAD 23.

collectComponents: (dictionary) defining the method of collecting the building material components of the parent object.

collectComponents.collectMode: (integer) the method of collecting the building material components. This key is optional, if it does not exist, the request uses a default collectMode of 1.

1: (default) returns all the building material component IDs of the parent

2: returns the same building material component IDs in the same order as in WALL_SKINS_PARAMS, SHELLBASE_SKINS_PARAMS, SLAB_SKINS_PARAMS or ROOF_SKINS_PARAMS - depending on the element type of the parent.

outputCompIds: (dictionary) the building material component IDs of the parent object.

outputCompIds.componentIds[n]: (array) contains dictionaries for each building material component ID.

outputCompIds.componentIds[n].id: (integer) the building material component ID of the parent element.

Example 8:

```
dict collectComponents
    collectComponents.collectMode = 1
dict outputCompIds
n = REQUEST ("Component_IDS_Of_Parent", collectComponents, outputCompIds)
! outputCompIds
    .componentIds[1].id
    .componentIds[2].id
    ...
    .componentIds[n].id
```

n = REQUEST ("Component_Property_Values_Of_Parent", compPropInput, compPropVals)

Returns a value dictionary for the given component ID and property IDs. Can be used only in labels. *Expression returns 0 and contains dummy return values (empty string or 0) if used in parameter script or used with unknown input dictionary key, causing additional warning.*

Compatibility: introduced in ARCHICAD 23.

compPropInput: (dictionary) defining the selected building material component and property IDs.

compPropInput.componentId: (dictionary) contains a dictionary for the selected building material component ID.

compPropInput.componentId.id: (integer) the selected building material component ID, available via the "Component_IDs_Of_Parent" request.

compPropInput.propertyIds[n]: (array) contains a dictionary for each selected property ID.

compPropInput.propertyIds[n].id: (string) the ID of the selected property.

compPropVals: (dictionary) the building material component property value data for the selected property IDs.

compPropVals.propertyValues[n]: (array) contains a dictionary for each property value.

compPropVals.propertyValues[n].value_status: the status of the selected property value

- 1: the selected property is available and has value
- 2: the selected property is available but no value has been defined for it
- 3: the property is unavailable, or the selected ID is not valid
- 4: the property value cannot be evaluated

compPropVals.propertyValues[n].type: the type of the selected property value. This key only exists in case the compPropVals.propertyValues[n].value_status is 1 or 2.

- 1: boolean
- 2: integer
- 3: real number
- 4: string
- 5: length
- 6: area
- 7: volume
- 8: angle

compPropVals.propertyValues[n].value[]: (array) contains the list of the selected property values.

Example 9:

```
dict compPropInput
  compPropInput.componentId.id = iActualID ! From "Component_IDs_Of_Parent" request
  compPropInput.propertyIds[1].id = "ExampleId1"
  compPropInput.propertyIds[2].id = "ExampleId2"
  ...
  compPropInput.propertyIds[n].id = "ExampleIdn"
dict compPropVals
n = REQUEST ("Component_Property_Values_Of_Parent", compPropInput, compPropVals)
! compPropVals = propertyValues[1].value_status
  .propertyValues[1].value_status
  .propertyValues[1].type
  .propertyValues[1].value[]
  .propertyValues[2].value_status
  .propertyValues[2].type
  .propertyValues[2].value[]
  ...
  .propertyValues[n].value_status
  .propertyValues[n].type
  .propertyValues[n].value[]
```

n = REQUEST ("Property_Name", "id", typeName, groupName, propertyName)

Returns the **type, group and name** of the selected property. Can be used only in labels. *Expression returns 0 and contains dummy return values (empty string or 0) if used in parameter script, causing additional warning.*

Compatibility: introduced in ARCHICAD 20.

id: the ID of the selected property (string).

typeName: the Type of the selected property (string).

"IFC": for IFC properties

"": other properties

groupName: the Group of the selected property (string).

empty string ("") for Core properties.

propertyName: the Name of the selected property (string).

n = REQUEST ("AUTOTEXT_LIST", "", autoTextListArray)

Returns one AUTOTEXT array of the autotexts used in the project with the following triplets ["ID", "Category", "Name"]. *Expression returns 0 and contains dummy return values (empty string or 0) if used in parameter script, causing additional warning. Can be used only in UI script.* The ID is stored in the parameter via the **UI_CUSTOM_POPUP...** commands.

Contains all autotexts from Project Info and Autotext Dialog (Text tool - Insert Autotext).

Compatibility: introduced in ARCHICAD 20.

Example 10:

```
DIM autoTextListArray[]
n = REQUEST ("AUTOTEXT_LIST", "", autoTextListArray)
! autoTextListArray = [ID1, CategoryName1, TextName1,
                      ID2, CategoryName2, TextName2,
                      ...
                      IDn, CategoryNamen, TextNamen]
```

n = REQUEST{3} ("Sum_with_rounding", req_name, addends_array, result)

Returns the sum of the numbers in **addends_array**, with rounding according to the "Calculate Totals by" project preference. This preference can be found in Options/Project Preferences/Calculation Units & Rules.

Possible project preference settings:

- "Displayed values": the request will first round the addends according to **req_name**, and then sum them.
- "Exact values": the request will simply sum the addends.

Causes warning if used in parameter script.

Compatibility: introduced in ARCHICAD 20.

Return values:

- 0, if **req_name** is invalid.
- 1, if the call succeeded.

req_name: the name of the formatting request specifying how the addends have to be rounded if "Calculate Totals by" is set to "Displayed values".

For example if **req_name = "Area_dimension"**, and the Project Preferences / Dimensions / Area Calculations is set to "square centimeter" with 3 decimals, rounding to 0.025, then the addends will be rounded to the multiples of 0.025 cm², that is to 0.0000025 m².

Valid request names:

Linear_dimension, Angular_dimension, Radial_dimension, Level_dimension, Elevation_dimension, Window_door_dimension, Sill_height_dimension, Area_dimension, Calc_length_unit, Calc_area_unit, Calc_volume_unit, Calc_angle_unit.

addends_array: the array of numbers to be added. Whether they have to be treated as m, m², m³ or degrees is determined by **req_name**.

result: a number, on return it will be set to the sum of the addends according to the "Calculate Totals by" preference. Note that **result** is in the same unit as the addends. It is not converted to the target unit specified by **req_name**.

n = REQUEST ("ASSOCLP_PARVALUE", expr, name_or_index, type, flags, dim1, dim2, p_values)

n = REQUEST ("ASSOCLP_PARVALUE_WITH_DESCRIPTION", expr, name_or_index, type, flags, dim1, dim2, p_values_and_descriptions)

Returns information in the given variables on the library part parameter with which the library part containing this request is associated. Can be used in property objects, labels and marker objects.

The function return value is the number of successfully retrieved values, 0 if the specified parameter does not exist or an error occurred.

expr: the request's object, associated library part parameter name or index expression.

name_or_index: returns the index or the name of the parameter, depending on the previous expression type (returns index if a parameter name, name if the index is specified).

type: parameter type, possible values:

- 1: boolean
- 2: integer
- 3: real number
- 4: string
- 5: length
- 6: angle
- 7: line
- 8: material
- 9: fill
- 10: pen color
- 11: light switch
- 12: rgb color
- 13: light intensity
- 14: separator
- 15: title
- 16: building material
- 17: profile *Compatibility: introduced in ARCHICAD 23*

flags:

$flags = j_1 + 2*j_2 + 64*j_7 + 128*j_8$, where each j can be 0 or 1.

j_1 : child/indented in parameter list

j_2 : with bold text in parameter list

j_7 : disabled (locked in all contexts)

j_8 : hidden in the parameter list

dim1, dim2: dim1 is the number of rows, dim2 the number of columns.

dim1 = 0, dim2 = 0: simple, scalar value

dim1 > 0, dim2 = 0: one dimensional array

dim1 > 0, dim2 > 0: two dimensional array

If dim2 > 0, then dim1 > 0.

p_values: for ASSOCLP_PARVALUE returns the parameter value or array of values. The array elements are returned successively, row by row as a one dimensional array, independently of the dimensions of the variable specified to store it. If the variable is not a dynamic array, there are as many elements stored as there is room for (for a simple variable only one, the first element). If values is a two dimensional dynamic array, all elements are stored in the first row.

p_values_and_descriptions: for ASSOCLP_PARVALUE_WITH_DESCRIPTION returns the parameter value followed by the parameter description string (as specified at the VALUES command command) or an array of these pairs. For string type parameters the description string is always empty. The array element - array element description string pairs are returned successively, row by row as a one dimensional array, independently of the dimensions of the variable specified to store it. If the variable is not a dynamic array, there are as many elements stored as there is room for (for a simple variable only one, the first element). If values is a two dimensional dynamic array, all elements are stored in the first row.

n = REQUEST ("ASSOCLP_NAME", "", name)

Returns in the given variable the name of the library part associated with the label or marker object. For elements (Walls, Slabs, etc.) the name is an empty string. *Expression returns 0 and contains dummy return values (empty string or 0) if used in parameter script, causing additional warning.*

n = REQUEST ("ASSOCEL_PROPERTIES", parameter_string, nr_data, data)

Returns, in the given variables, own property data or the element properties which the library part containing this request is associated to (in labels and associative marker objects). The function return value is the number of successfully retrieved values, 0 if no property data was found or an error occurred. The function does not work in property objects during the listing process. *Expression returns 0 and contains dummy return values (empty string or 0) if used in parameter script, causing additional warning.*

parameter_string: a combination of keywords separated by commas representing the requested fields of the property data records.

Records will be ordered accordingly. Possible values:

"ISCOMP"

```

"DBSETNAME"
"KEYCODE"
"KEYNAME"
"CODE"
"NAME"
"FULLNAME"
"QUANTITY"
"TOTQUANTITY"
"UNITCODE"
"UNITNAME"
"UNITFORMATSTR"
"PROPOBJNAME"

```

nr_data: returns the number of the data items.

data: returns the property data, records containing and being ordered by the fields specified in the parameter string. Values are returned as a one dimensional array which contains the requested record fields successively, independently of the dimensions of the variable specified to store it. If the variable is not a dynamic array, there are as many elements stored as there is room for (in case of a simple variable only one, the first element). If values is a two dimensional dynamic array, all elements are stored in the first row.

Example 11:

```

DIM DATA []
n = REQUEST ("ASSOCEL_PROPERTIES", "iscomp, code, name", nr, data)
IF nr = 0 THEN
  TEXT2 0, 0, "No properties"
ELSE
  j = 0
  FOR i = 1 TO nr
    IF i MOD 3 = 0 THEN
      TEXT2 0, -j, DATA [i] ! name
      j = j + 1
    ENDIF
  NEXT i
ENDIF

n = REQUEST ("REFERENCE_LEVEL_DATA", "", name1, elev1, name2, elev2,
  name3, elev3, name4, elev4)

```

Returns in the given variables the names and elevations of the reference levels as set in the Options/Project Preferences/Reference Levels dialog. The function return value is the number of successfully retrieved values, 0 if an error occurred.

```
n = REQUEST ("ANCESTRY_INFO", expr, name [, guid,
             parent_name1, parent_guid1,
             ...
             parent_namen, parent_guidn)
```

Ancestry information on a library part. *Expression returns 0 and contains dummy return values (empty string or 0) if used in parameter script, causing additional warning.*

If `expr = 0`, returns in the given variables the name and the globally unique identifier of the library part containing this request function. Optionally the function returns the names and globally unique identifiers of the parents of the library part (`parent_namei`, `parent_guidi`). If the parent templates are not loaded their names will be empty strings.

If `expr = 1`, returns information on the library part replaced by the template containing this function. In this case if the template is not actually replacing, no values are returned.

The return value of the request is the number of successfully retrieved values.

Example 12:

```
DIM strings[]
n = REQUEST ("ANCESTRY_INFO", 1, name, guid, strings)
IF n > 2 THEN
    ! data of replaced library part
    TEXT2 0, -1, "replacing: " + name + ' ' + guid
    ! parents
    l = -2
    FOR i = 1 TO n - 2 STEP 2
        TEXT2 0, 1, strings [i]
        l = l - 1
    NEXT i
ENDIF
```

```
n = REQUEST ("TEXTBLOCK_INFO", textblock_name, width, height)
```

Returns in the given variables the sizes in x and y direction of a text block previously defined via the TEXTBLOCK command. The sizes are in mm or in m in model space depending on the `fixed_height` parameter value of TEXTBLOCK (millimeters if 1, meters in model space if 0). If width was 0, the request returns the calculated width and height, if width was specified in the text block definition, returns the calculated height corresponding to that width. *Expression returns 0 and contains dummy return values (empty string or 0) if used in parameter script, causing additional warning.*

n = REQUEST{2} ("Material_info", name_or_index, param_name, value_or_values)

Returns information in the given variable(s) on a parameter (or extra parameter, see the section called “Additional Data”) of the specified material. RGB information is returned in three separate variables, texture information is returned in the following variables: file_name, width, height, mask, rotation_angle corresponding to the texture definition. All other parameter information is returned in single variables. *Expression returns 0 and contains dummy return values (empty string or 0) if used in parameter script, causing additional warning.* Possible material parameter names corresponding to parameters of the material definition:

param_name:

"gs_mat_surface_rgb": surface R, G, B [0.0..1.0]
 "gs_mat_surface_r": surface R [0.0..1.0]
 "gs_mat_surface_g": surface G [0.0..1.0]
 "gs_mat_surface_b": surface B [0.0..1.0]
 "gs_mat_ambient": ambient coefficient [0.0..1.0]
 "gs_mat_diffuse": diffuse coefficient [0.0..1.0]
 "gs_mat_specular": specular coefficient [0.0..1.0]
 "gs_mat_transparent": transparent coefficient [0.0..1.0]
 "gs_mat_shining": shininess [0.0..100.0]
 "gs_mat_transp_att": transparency attenuation [0.0..4.0]
 "gs_mat_specular_rgb": specular color R, G, B [0.0..1.0]
 "gs_mat_specular_r": specular color R [0.0..1.0]
 "gs_mat_specular_g": specular color G [0.0..1.0]
 "gs_mat_specular_b": specular color B [0.0..1.0]
 "gs_mat_emission_rgb": emission color R, G, B [0.0..1.0]
 "gs_mat_emission_r": emission color R [0.0..1.0]
 "gs_mat_emission_g": emission color G [0.0..1.0]
 "gs_mat_emission_b": emission color B [0.0..1.0]
 "gs_mat_emission_att": emission attenuation [0.0..65.5]
 "gs_mat_fill_ind": fill index
 "gs_mat_fillcolor_ind": fill color index
 "gs_mat_texture": texture index

Example 13:

```
n = REQUEST{2} ("Material_info", "Brick-Face", "gs_mat_ambient", a)
n = REQUEST{2} ("Material_info", 1, "gs_mat_surface_rgb", r, g, b)
n = REQUEST{2} ("Material_info", "Brick-Face", "gs_mat_texture",
               file_name, w, h, mask, alpha)
n = REQUEST{2} ("Material_info", "My-Material", "my_extra_parameter", e)
```

n = REQUEST{2} ("Building_Material_info", name_or_index, param_name, value_or_values)

Returns information in the given variable(s) on a parameter of the specified building material. *Expression returns 0 and contains dummy return values (empty string or 0) if used in parameter script, causing additional warning.* Possible building material parameter names corresponding to parameters of the building material definition:

param_name:

- "gs_bmat_id": building material id
- "gs_bmat_surface": building material surface index
- "gs_bmat_description": building material description
- "gs_bmat_manufacturer": building material manufacturer
- "gs_bmat_collisiondetection": building material participates in collision detection (0 or 1)
- "gs_bmat_intersectionpriority": building material intersection priority
- "gs_bmat_cutFill_properties": building material cut fill properties (cut fill index number, cut fill foreground pen index number, cut fill background pen index number)
- "gs_bmat_physical_properties": building material physical properties (thermal conductivity, density, heat capacity, embodied energy, embodied carbon)

Example 14:

```
n = REQUEST{2} ("Building_Material_info", "Brick", "gs_bmat_id", id)
n = REQUEST{2} ("Building_Material_info", "Brick", "gs_bmat_surface", index)
n = REQUEST{2} ("Building_Material_info", "Brick", "gs_bmat_physical_properties",
               thermalConductivity, density, heatCapacity, embodiedEnergy, embodiedCarbon)
```

n = REQUEST ("FONTNAMES_LIST", "", fontnames)

Returns in the given variables the fontnames available on the current computer (with character codes included). This list (or any part of this list) can be used in a VALUES command to set up a fontname popup. The function return value is the number of successfully retrieved values, 0 if an error occurred.

Example 15:

```
dim fontnames[]
n = REQUEST ("FONTNAMES_LIST", "", fontnames)
VALUES "f" fontnames, CUSTOM
```

This form of the VALUES command assembles a fontnames pop-up for the simple string-typed parameter "f". The "fontnames" variable contains the possible fontnames (with character codes included) which can be set manually or using the REQUEST ("FONTNAMES_LIST", ...) command. The CUSTOM keyword is necessary for the correct handling of missing fonts on other platforms/computers: if it is specified, a fontname set on another platform/computer missing in the current environment will be preserved in the parameter settings as a custom value (otherwise, due to the implementation of the VALUES command, a missing string popup value in the parameter settings will be replaced with the first current string value). It is recommended to include this function in the ARCHICAD_Library_Master file.

```
n = REQUEST ("HomeDB_info", "", homeDBIntId, homeDBUserId, homeDBName, homeContext)
```

Returns in the given variables the internal ID (integer), the user ID and name (strings) of the home database (where the library part containing this request was placed).

- if placed on the floor plan: the story internal ID, index as a string and name, homeContext = 1,
- if placed on a section: the section internal ID, reference ID and name, homeContext = 2,
- if placed on a detail: the detail internal ID, reference ID and name, homeContext = 3,
- if placed on a master layout: the layout internal ID, empty string and name, homeContext = 4,
- if placed on a layout: the layout internal ID, number and name, homeContext = 5.

For labels the returned data refers to the labeled element. The collected data can be used to uniquely identify elements in different ARCHICAD databases of a plan file. Causes warning if used in parameter script.

```
n = REQUEST ("floor_plan_option", "", storyViewpointType)
```

Returns the story viewpoint type which is set in the Model View Options. 0 stands for "Floor Plan", 1 stands for "Ceiling Plan". *Expression returns 0 and contains dummy return values (empty string or 0) if used in parameter script, causing additional warning.*

```
n = REQUEST ("class_of_fill", index, class)
```

Returns class of the fill identified by index in the class variable. Causes warning if used in parameter script.

class: Possible values:

- 1: vector fill
- 2: symbol fill
- 3: translucent fill
- 4: linear gradient fill
- 5: radial gradient fill

6: image fill

n = REQUEST ("view_rotangle", "", angleViewRotation)

Returns the rotation angle of the current view. *Expression returns 0 and contains dummy return values (empty string or 0) if used in parameter script, causing additional warning.*

n = REQUEST ("program_info", "", name[, version[, keySerialNumber[, isCommercial]])]

Returns information on the currently running program. *Expression returns 0 and contains dummy return values (empty string or 0) if used in parameter script, causing additional warning.*

name: name of the program

version: version number of the program

keySerialNumber: serial number of the keyplug

isCommercial: returns true if there is running a full (commercial) version of the program

n = REQUEST ("Configuration_number", "", stConfigurationNumber)

Returns the configuration number (as string expression) assigned to the current ARCHICAD license in case of soft license or hardware key. Returns empty string in case of Edu, Trial or Demo licenses. Each configuration number is unique and does not change.

Expression returns 0 and contains dummy return values (empty string or 0) if used in parameter script, causing additional warning.

Compatibility: introduced in ARCHICAD 20.

n = REQUEST (extension_name, parameter_string, variable1, variable2, ...)

If the question isn't one of those listed above, the REQUEST() function will attempt to use it as an extension-specific name. If this extension is loaded, it will be used to get as many variable names as are specified. The parameter string is interpreted by the extension.

n = REQUEST ("COMPONENT_PROJECTED_AREA", idxSkin, projectedArea)

Returns the projected area of the indexed skin. Available in property script only (other scripts return 0). *Expression returns 0 and contains dummy return values (empty string or 0) if used in parameter script, causing additional warning.*

idxSkin: Possible values:

0: for basic elements

1- : index of the skin in composites

1- : index of the component in profiles

Example 16:

```
n = request ("COMPONENT_PROJECTED_AREA", 0, a)
COMPONENT "Projected Area", a, "m2"
```

Used in property script, first request the area of the skin, then create a component using the returned value.

```
n = REQUEST ("COMPONENT_VOLUME", idxSkin, skinVolume)
```

Returns the volume of the indexed skin/component. Available in property script only (other scripts return 0). *Expression returns 0 and contains dummy return values (empty string or 0) if used in parameter script, causing additional warning.*

idxSkin: Possible values:

- 0: for basic elements
- 1- : index of the skin in composites
- 1- : index of the component in profiles

Example 17:

```
n = request ("COMPONENT_VOLUME", 0, v)
COMPONENT "Volume", v, "m3"
```

Used in property script, first request the volume of the skin, then create a component using the returned value.

```
n = REQUEST ("DateTime", format_string, datetimestring)
```

Returns the current date and time as a formatted string in `datetimestring`. Uses the DateTime Add-On, opening and closing the required channel.

format_string: Format string, described at *paramString* parameter of the section called “Opening Channel”.

datetimestring: the formatted string is returned in this variable

The requests cause warning if used in parameter script.

Profile Requests

```
n = REQUEST ("Name_of_Profile", index, name)
```

Returns in the name variable the profile name identified by `index`. *Expression returns 0 and contains dummy return values (empty string or 0) if used in parameter script, causing additional warning.*

Compatibility: introduced in ARCHICAD 21.

```
n = REQUEST ("Profile_components", name_or_index, nComponents,
             compType1, compType2, ..., compTypeN)
```

Returns the number (`nComponents`) and component types (`compTypeN`) of the profile identified by name or index. *Expression returns 0 and contains dummy return values (empty string or 0) if used in parameter script, causing additional warning.*

compTypei: Possible values of profile component types:

- 0: core
- 1: finish
- 2: other

Compatibility: introduced in ARCHICAD 21.

Example 1:

```
_nComponents = 0
_dim _componentTypes[]
n = REQUEST ("Profile_components", myProfileIdx, _nComponents, _componentTypes
```

```
n = REQUEST ("Profile_default_boundingbox", name_or_index, xmin, ymin, xmax, ymax)
```

Returns the 2 defining coordinate point of the original bounding rectangle relative to the origo of the profile identified by name or index.

Expression returns 0 and contains dummy return values (empty string or 0) if used in parameter script, causing additional warning.

Compatibility: introduced in ARCHICAD 21.

```
n = REQUEST ("Profile_default_geometry", name_or_index, n1, n2, ..., nm,
  x11, y11, edgeVisible11, vertEdgeVisible11, additionalStatus11, ...,
  x1n1, y1n1, edgeVisible1n1, vertEdgeVisible1n1, additionalStatus1n1,
  x21, y21, edgeVisible21, vertEdgeVisible21, additionalStatus21, ...,
  x2n2, y2n2, edgeVisible2n2, vertEdgeVisible2n2, additionalStatus2n2, ...,
  xm1, ym1, edgeVisiblem1, vertEdgeVisiblem1, additionalStatusm1, ...,
  xmnm, ynm, edgeVisiblemnm, vertEdgeVisiblemnm, additionalStatusmnm)
```

Returns the original geometric data of the profile identified by name or index. *Expression returns 0 and contains dummy return values (empty string or 0) if used in parameter script, causing additional warning.*

n1...ni: then number of contour nodes in each profile component. The total number of profile components (m) can be returned by the "Profile_components" request.

edgeVisiblei: contour starting from i node is visible.

vertEdgeVisiblei: vertical edge starting from i node is visible, usable in 3D (0 in case of segmented polygon).

additionalStatusi: used for segments and arcs of the polyline (set centerpoint = 900, arc using centerpoint and angle = 4000, etc.), or to mark the contour end control point (-1, this case the **vertEdgeVisiblei** and **edgeVisiblei** are set to 0 automatically).

The status parameters returned in this structure support different status type definitions of poly2, cprism, tube. Each format can be calculated with the following method:

Example 2:

```

poly2Status = edgeVisible + additionalStatus
prismStatus = additionalStatus
tubeStatus = additionalStatus
if additionalStatus >= 0 then          ! not contour end
  if edgeVisible then
    prismStatus = prismStatus + 15    ! j1, j2, j3, j4
  endif
  if verticalEdgeVisible = 0 then
    prismStatus = prismStatus+ 64    ! j7
    ! in tube, lateral edges starting from the node are used for showing the contour
    tubeStatus = tubeStatus + 1
  endif
endif
endif

```

Compatibility: introduced in ARCHICAD 21.

n = REQUEST{4} ("Profile_component_info", name_or_index, component_ind, param_name, value)

Returns a requested attribute value of a dedicated component (by `component_ind`) of the profile identified by name or index. *Expression returns 0 and contains dummy return values (empty string or 0) if used in parameter script, causing additional warning.*

The `component_ind` must be in the valid range of `nComponents` (defined by "Profile_components" request).

param_name: addresses attribute settings of Profile Manager, returned in value

"gs_profile_bmat": building material index of the component

"gs_profile_surface": override surface index of the component (in case of active override settings; returns the surface of the building material otherwise)

"gs_profile_showoutline": "Show Outline" setting of the component

"gs_profile_outlinetype": "Outline Type" setting of the component

"gs_profile_outlinepen": "Outline Pen" setting of the component

Return attribute values can be used in any attribute related command, such as `POLY2_B{6}`, where contour sections of the polygon can be customized individually.

Compatibility: introduced in ARCHICAD 21.

n = REQUEST{4} ("Profile_component_info", name_or_index, component_ind, param_name, value1, value2, ..., valuen)

Returns requested attributes of all edges in the dedicated component (by `component_ind`) of the profile identified by name or index. *Expression returns 0 and contains dummy return values (empty string or 0) if used in parameter script, causing additional warning.*

The `component_ind` must be in the valid range of `nComponents` (defined by "Profile_components" request).

param_name: addresses attribute settings of Profile Manager, returned in value

- "gs_profile_comp_surfaces": individual surface indexes of edges of the component
- "gs_profile_comp_pens": individual pen indexes of edges of the component
- "gs_profile_comp_linetypes": individual linetype indexes of edges of the component

Return attribute values can be used in any attribute related command, such as `POLY2_B { 6 }`, where contour sections of the polygon can be customized individually.

Compatibility: introduced in ARCHICAD 21.

Deprecated Requests

n = REQUEST ("Constr_Fills_display", "", optionVal)

Expression returns 0 and contains dummy return values (empty string or 0) if used in parameter script, causing additional warning.

Compatibility up till ARCHICAD 19: returns in the given variable the value of the Cut Fills Display option as set in the Document/ Set Model View/ Model View Options. (previous Construction Fills).

Compatibility starting from ARCHICAD 20: the returned value is always 6 by default (Cut fill patterns: as in Settings).

optionVal: cut fill display code.

- 1: Show cut fill contours only (previous Empty)
- 2: Show cut fill contours only with separator lines (previous No Fills)
- 4: Cut fill patterns: Solid (previous Solid)
- 6: Cut fill patterns: as in Settings (previous Vectorial Hatching)

n = REQUEST ("internal_ID", "", id)

Always returns 1. Use GLOB_INTGUID global variable instead.

APPLICATION QUERY OPTIONS

n = APPLICATION_QUERY (extension_name, parameter_string, variable1, variable2, ...)

Below is a list of request functions ARCHICAD can provide with the help of the `APPLICATION_QUERY` command. These request options are given in the **extension_name** and the **parameter_string** parameter of the command. Note, that the query options and return values of an `APPLICATION_QUERY` may vary according to the execution context.

The use of the following application query types in parameter script is not supported. These queries cause GDL warnings starting from ARCHICAD 19, and will return either 0 or empty string starting from the next versions. The restriction applies to:

- "document_feature"

Document feature

This command can return features of the active document/view. Currently there is only one feature it can return - the view direction of the document. These type of queries are restricted from the parameter script and cause GDL warnings.

View direction

```
n = APPLICATION_QUERY ("document_feature", "view_direction", type)
```

This command returns the viewing direction of the current document type in which the object is being visualized. This command has no additional parameters.

type: Returned type values:

"vertical_only": for floor plan

"horizontal_only": for section and elevation generated from 3D (not when the object is placed into a S/E)

"free": for 3D and 3D document

"none"

"unset"

MEP System

This command returns MEP system types and information about MEP systems. It has more functions which can be addressed via the **parameter_string** parameter:

Get MEP Systems

```
DIM d[2][]
```

```
n = APPLICATION_QUERY ("MEPSYSTEM", "GetMEPSystems(domain)", d)
```

domain: MEP classification index (DuctWork – 1, PipeWork – 2) (GDL defines the MEP classifications based on connector class)

d: Array of values:

[2*k-1]: MEP system index

[2*k]: MEP system name

n: Number of MEP systems multiplied by 2.

Get Domain

```
n = APPLICATION_QUERY ("MEPSYSTEM", "GetDomain(idx)", d)
```

idx: MEP system index

d: domains (integer)

- 1: DuctWork
- 2: PipeWork
- 3: Duct- and PipeWork
- 4: Cabling
- 5: DuctWork and Cabling
- 6: PipeWork and Cabling
- 7: DuctWork, PipeWork and Cabling

n: 1 if successful, 0 otherwise

Get Contour Pen

n = **APPLICATION_QUERY** ("MEPSYSTEM", "GetContourPen (idx)", pen)

idx: MEP system index

pen: contour pen index (integer)

n: 1 if successful, 0 otherwise

Get Fill Pen

n = **APPLICATION_QUERY** ("MEPSYSTEM", "GetFillPen (idx)", pen)

idx: MEP system index

pen: fill pen index (integer)

n: 1 if successful, 0 otherwise

Get Background Pen

n = **APPLICATION_QUERY** ("MEPSYSTEM", "GetBgPen (idx)", pen)

idx: MEP system index

pen: background pen index (integer)

n: 1 if successful, 0 otherwise

Get Fill Type

n = **APPLICATION_QUERY** ("MEPSYSTEM", "GetFillType (idx)", filltype)

idx: MEP system index

filltype: fill type index (integer)

n: 1 if successful, 0 otherwise

Get Center Line Type

`n = APPLICATION_QUERY ("MEPSYSTEM", "GetCenterLineType (idx)", line)`

idx: MEP system index

line: center line type index (integer)

n: 1 if successful, 0 otherwise

Get Center Line Pen

`n = APPLICATION_QUERY ("MEPSYSTEM", "GetCenterLinePen (idx)", pen)`

idx: MEP system index

pen: center line pen index (integer)

n: 1 if successful, 0 otherwise

Get System Material

`n = APPLICATION_QUERY ("MEPSYSTEM", "GetSystemMaterial (idx)", material)`

idx: MEP system index

material: system material index (integer)

n: 1 if successful, 0 otherwise

Get Insulation Material

`n = APPLICATION_QUERY ("MEPSYSTEM", "GetInsulationMaterial (idx)", material)`

idx: MEP system index

material: insulation material index (integer)

n: 1 if successful, 0 otherwise

MEP Modeler

This command returns whether MEP modeler is active. It has one function which can be addressed via the **parameter_string** parameter:

Is Available

```
n = APPLICATION_QUERY ("MEPMODELER", "IsAvailable()", isavailable)
```

isavailable: MEP Modeler is present (integer)

n: 1 if successful, 0 otherwise

MEP Connection Type

This command returns the connection types and the styles of connection types. It has two functions which can be addressed via the **parameter_string** parameter:

Get Connection Types

```
DIM d[2][ ]
```

```
n = APPLICATION_QUERY ("MEPCONNECTIONTYPE", "GetConnectionTypes(connectorClass)", d)
```

connectorClass: connector class (Duct – 1, Pipe – 2, Cable carrier – 3)

d: Array of values:

[2*k-1]: connection type GUID

[2*k]: connection type name

n: Number of connection types multiplied by 2.

Get Connection Type Style

```
DIM d[ ]
```

```
n = APPLICATION_QUERY ("MEPCONNECTIONTYPE", "GetConnectionTypeStyle(connectorClass)", d)
```

connectorClass: connector class (Duct – 1, Pipe – 2, Cable carrier – 3)

d: Array of values:

[]: connection type styles

n: Number of connection types.

MEP Flexible Segment

This command returns the geometry of flexible segments. It has four functions which can be addressed via the **parameter_string** parameter:

Start Sectioning

```
n = APPLICATION_QUERY ("MEPFLEXIBLESEGMENT", "StartSectioning()", r)
```

Indicates that sectioning has begun.

r: not used

n: 1 if successful, 0 otherwise

Add Control Point

```
n = APPLICATION_QUERY ("MEPFLEXIBLESEGMENT", "AddControlPoint(x; y; z)", r)
```

Provides a control point to the add-on.

AddControlPoint:

x: X coordinate of the control point

y: Y coordinate of the control point

z: Z coordinate of the control point

r: not used

n: 1 if successful, 0 otherwise

Add Direction and Width Vector

```
n = APPLICATION_QUERY ("MEPFLEXIBLESEGMENT",
    "AddDirectionAndWidthVector(i; dx; dy; dz; wx; wy; wz)", r)
```

Provides the direction and side vectors of the ends of spline to add-on. It is called twice.

AddDirectionAndWidthVector:

i: id of port (1: 0. port, 2: 1. port etc.)

dx: X component of direction vector of the port

dy: Y component of direction vector of the port

dz: Z component of direction vector of the port

wx: X component of side vector of the port

wy: Y component of side vector of the port

wz: Z component of side vector of the port

r: not used

n: 1 if successful, 0 otherwise

End Sectioning

DIM d[]

n = **APPLICATION_QUERY** ("MEPFLEXIBLESEGMENT", "EndSectioning(res)", d)

Getting of the result of sectioning.

res: resolution of sectioning

d: Array of values:

- [9*k-8]: X position of k segment
- [9*k-7]: Y position of k segment
- [9*k-6]: Z position of k segment
- [9*k-5]: X component of tangent vector of k segment
- [9*k-4]: Y component of tangent vector of k segment
- [9*k-3]: Z component of tangent vector of k segment
- [9*k-2]: X component of normal vector k segment
- [9*k-1]: Y component of normal vector k segment
- [9*k]: Z component of normal vector k segment

n: Number of segments

MEP Bend

This command returns the geometry of flexible segment. It has four functions which can be addressed via the **parameter_string** parameter:

Start Sectioning

n = **APPLICATION_QUERY** ("MEPBEND", "GetBendTypeNames()", d)

d: Bend Type Names (examples of INT version)

- "Radius"
- "Square Throat"
- "Mitered"
- "45° Throat with 45° Heel"
- "45° Throat with 90° Heel"

```
"45° Throat with Radius Heel"
"Radius Throat with 90° Heel"
"Pleated"
"Stamped"
"Segmented"
"Segmented Standing Seam"
```

n: 1 if successful, 0 otherwise

Parameter Script

This command can return various conditions of the parameter script. Currently there is only one feature it can return - the distinction of the first run.

First Occasion in Progress

```
n = APPLICATION_QUERY ("parameter_script", "firstoccasion_in_progress", isFirstRun)
```

This command returns whether the current run is the first run or a consequence of a previous execution of the parameter script which changed some parameters. This command has no additional parameters.

The distinction may be important when a part of the parameter script executes a triggered event - e.g. it handles the pushing of a function button.

isFirstRun: The returned value shows whether the current run is the first run

Tags and Categories

These commands return the folder names, parameter names and parameter values of "Tags and Categories" tabpage. The order of parameters is the same as on the tabpage. There are two possible **extension_names** in these commands:

- **"OwnCustomParameters"** returns parameters of the object
- **"ParentCustomParameters"** returns parameters of the object's parent

Get Parameter Folder Names

```
DIM folderNamesArray[] ! [idString 1],[shortNameString 1],[longNameString 1],
                        ! ...
                        ! [idString n],[shortNameString n],[longNameString n]
n = APPLICATION_QUERY (extension_name, "GetParameterFolderNames()", folderNamesArray)
```

Returns the folder names of Tags and Categories parameters.

folderNamesArray: String array which contains the foldernames of Tags and Categories

n+1: Number of folders including the root folder

Get Parameter Names

```
DIM parNamesArray[] ! [idString 1],[shortNameString 1],[longNameString 1],
                    ! ...
                    ! [idString n],[shortNameString n],[longNameString n]
n = APPLICATION_QUERY (extension_name,
                      "GetParameterNames(folderNamesArray[i][1])", parNamesArray)
```

Returns the names of Tags and Categories parameters.

The first column of the array returned at the section called "Get Parameter Folder Names".

parNamesArray: String array which contains the names of Tags and Categories parameters

n: Number of parameters

Get Parameters

```
n = APPLICATION_QUERY (extension_name, "GetParameter(parNamesArray[i][2])", parValue)
```

Returns the values of Tags and Categories parameters.

The second column of the array returned at the section called "Get Parameter Names".

parValue: String which contains the value of Tags and Categories parameters

n: 1 if successful, 0 otherwise

Library manager

This command can return various features of the library manager.

Ies files

```
n = APPLICATION_QUERY ("LIBRARY_MANAGER", "IES_FILES", ies_files_list)
```

This command returns the list of file names with .ies extensions loaded with the active libraries.

User image files

```
n = APPLICATION_QUERY ("LIBRARY_MANAGER", "USER_IMAGE_FILES", image_files_list)
```

This command returns the list of user-provided image file names loaded with the active libraries (image files which are not in the dedicated folders with names containing [TImg]*, [BImg]*, [UImg]*, or [HImg]*)

GDL STYLE GUIDE

Introduction

This document contains the GDL coding standard of GRAPHISOFT, which mainly sets the formal requirements for writing source code. It also describes a few rules and recommendations for the content. You have to obey these rules in order to produce manageable scripts; by default every declarative or imperative sentence is a rule, except where 'recommendation' (or avoidable, optional, etc.) is explicitly stated.

This document was created to establish a common format of GDL scripting. The GDL language is insensitive to the character case and most of the whitespace characters. As a result, lots of coding practices and standards exist. This gets intolerable, when such practices meet in the same project or organization. The following sections describe the GRAPHISOFT company standard, which remains purely a recommendation for non-GRAPHISOFT related developers. The supposed format will not be included in the GDL language's constraints ever.

Naming Conventions

General rules

Because of the subtype hierarchy, the child library parts automatically inherit all parameters of the parent. (Read more about subtypes and parameter in the ARCHICAD User Guide). Parameters are identified by their name, so inherited and original parameters can have the same name. It is the responsibility of the library author to avoid conflicts by using descriptive parameter names prefixed with abbreviated library part names. For handler parameters and user-defined parameters, GRAPHISOFT has introduced a parameter naming convention in its libraries.

Note

Handlers add extra functionality to library parts (e.g. doors and windows cut holes in walls). Parameter names with the prefix `ac_` are reserved for special parameters associated with ARCHICAD handlers (e.g. `ac_corner_window`). Check the standard ARCHICAD Library subtype templates for the complete list.

Standard GRAPHISOFT parameter names are marked with the `gs_` prefix (e.g. `gs_frame_pen`). Please check the ARCHICAD library parts for reference. Use these parameters in your GDL scripts to ensure full compatibility with GRAPHISOFT libraries.

`FM_` is reserved for ArchiFM (e.g. `FM_Type`).

Variable names

Variable and parameter names should be related with the function of the parameter.

mixedCase: starts with a lowercase letter; every new word should start with an uppercase letter. E.g.: `size`, `bRotAngle180`, `upperLeftCorner`

Don't use one or two letter variable names - no one will know what you meant.

You should use a prefix in generally used variable names to denote general categories. This can spare time when someone needs to find out the type of a variable or parameter. Don't forget to replace the prefix if you change the meaning of a variable.

Table 6. Variable name prefixes

Prefix	Meaning	Example
i	General integer value / integer index	iRiser
n	Integer value - amount of something	nRiser
b	Boolean value	bHandrail
st	String type value	stPanelTypes
x	X coordinate of a point	xRailPos
y	Y coordinate of a point	yRailPos
pen	Pen color	penContour
lt	Linetype	ltContour
fill	Fill type	fillMainBody
mat	Material type	matCover

Using underscores (_) is recommended for distinguishing variables and parameters in the same script: use single underscore (_) prefix for a variable in a script, and double (__) for a variable declared and used only inside a subroutine section. Do not use underscores in the beginning of parameter names, or to separate words in a name. Historical names coming from subtypes are exceptions.

Example

```

__iDoorTypes = iDoorTypes
! " __iDoorTypes" variable gets the value of "iDoorTypes" parameter
gosub "exampleScript"
end

"exampleScript":
    __iDoorTypes = _iDoorTypes * 3
    ! " __iDoorTypes" subroutine variable gets the value of 3 times " _iDoorTypes" variable
return

```

Capitalization

- Commands should be written consistently lowercase or uppercase according to your taste. **GRAPHISOFT recommends lowercase.**
- GDL global variables should always be written uppercase for easier script reading.
- The following keywords should be lowercase: `call`, `goto`, `gosub`, `parameters`.

Expressions

- Space should be used in front of and behind the following binary operators:
 - arithmetical: `*`, `/`, `%` (mod), `+`, `-`, `^` (**)
 - logical: `&` (and), `|` (or), `@` (excluding or), `=`, `<>` (#), `<`, `<=`, `>`, `>=`
 - assignment: `=`
 E.g.:
`a = (b + c % d) * e`
- No spaces are allowed in front of and behind the following unary operators:
 - subscripting: `array[25]` Note: avoid space inside brackets (`array[5]`) to make "find" function easier
 - logical not: `not(x)`
 - unary minus, unary plus: `-x`, `+x`
- Function calls should have a space in front of the opening parenthesis of the parameter list, and behind every comma separating the parameters:

```
abs (signedLength)
minimum = min (a, 25 * b, c)
```
- When testing equality with constants (e.g. `i = 5`) the constant should be the second operand.
- When assigning values to Boolean variables the logical expression should be parenthesized:

```
bBoolValue = (i > j)
```
- Do not use the Boolean result of logical negation of integer values or variables. E.g. instead of `if not (iIntVal) then` please use `if iIntVal = 0 then`. (Of course, Boolean variables and expressions can be negated, e.g. `if not (bBoolVal) then`).
- Do not compare Boolean variables and expressions to true or false; use the value of Boolean or its negated value:

```
bBoolVal = 1
if bBoolVal then          ! instead of: if bBoolVal = 1
...
endif
if not(bBoolVal) then    ! instead of: if bBoolVal = 0
...
endif
```
- Complex expressions (e.g. where and and or are both present) should be parenthesized to clarify precedence.

- Put parentheses around rarely used operator combinations.
- Logical expressions consisting of many parts should be placed on multiple lines, and you should also align the sub-expressions or the logical operators:

```
bResult = (bValue1      & bValue3      & not(bValueWithLongerName)) | \
          (not(bValue1) & not(bValue3) & bValueWithLongerName) | \
          (not(bValue12) & bValue3      & not(bValueWithLongerName)) | \
          (bValue2      & not(bValue3)  & bValueWithLongerName)
```

Control flow statements

if - else - endif

Avoid using the one line form of conditional expressions.

To improve code readability, it is essential to express the hierarchy of nested statements. The following example shows the recommended tabulation of code blocks.

```
if condition1 then
    statement1
    ...
    statementn
else
    statementn+1
    ...
    statementn+m
endif

if condition2 then
    if condition3 then
        ...
    else
        ...
    endif
    if condition4 then
        ...
    endif
else
    ...
endif
```

for - next, do - while, while - endwhile, repeat - until

To improve code readability, it is essential to express the hierarchy of nested statements. The following example shows the recommended tabulation of code blocks.

```
for i = initialValue to endValue
    statement1
    ...
    statementn
next i

do
    ...
    for i = initialValue to endValue
        statement1
        ...
        statementn
    next i
    ...
    bCondition = ...
    ...
while bCondition
```

Subroutines

Pieces of code that are needed more than once should be turned into subroutines. This makes later corrections less risky, and the code more structured. The label of the subroutine should correspond with its function. Do not use numbers as names, it makes the code unreadable. Variables used and declared only inside a subroutine should start with double underscore.

Style (*italic texts should be replaced implicitly*):

```

! =====
! Short description of the functionality
! -----
! Input Parameters:
!   par1: short description (type)
!   par2: short description (type)
!   ...
! Output:
!   par1: short description
!   ...
! Remark:
!   Remarks for the caller
!   Description of key points of the implementation
! =====

subroutine_title:
! body
return

```

You should write the body of the subroutine indented by one tabulator field to the right.

You should leave two empty lines behind the closing 'return' of the subroutine.

You should write one statement per line.

Subroutines shouldn't be longer than 1-2 screens (about 80 lines) if possible.

Check all incoming parameters for validity and/or declare the restriction in comment

The call and parameters keywords are lowercase.

Writing comments

The language of the comments should be English; avoid bad words.

You should use the following style for comments:

Script header

It is only a recommendation

```

! <contact person initials>
! =====
!   One sentence description of the purpose of the script
! -----
! Input Parameters:
!   par1:   description of the parameter (integer)
!   par2:   description of the parameter (1 / -1)
!   par3:   description of the parameter (0 / 1)
!   ...
! Output: [if a macro returns values]
!   [1]:   description of the value (type)
!   [2]:   description of the value (type)
!   [ ... NSP]: original stack elements
! Remark:
!   Longer description.
!   Note for the caller
! =====

```

Any code can come only after this.

Section divide

```

! =====
! Section name
! =====

```

The length of the full comment line is 80 characters.

For the subroutines you should always explain the meaning of non-trivial parameters and the return value. E.g. for indices always indicate the range (starts from 0 or 1, any special values, etc.).

Example in the section called “Subroutines”

You should always indicate with the TODO keyword if you leave something unfinished, it's easy to search for later:

```
n = 5 ! TODO: set initials; it will be computed from the length
```

You can also put optional section descriptions in between the lines of the source code, beginning at the current tab depth. You can also add short explanations to the end of the source line by adding a tab at the end; or, if there are more of those, you can align them with tabs.

You should always add comments:

- For unusual solutions
- If it would help others understand the code more quickly.
- If something is forbidden or not recommended for others.

Optional (others will be thankful) if it helps in any way.

Do not let the comments break the rhythm of the code, or the merits of the code.

When commenting a coherent code block, you may use the following format:

```
! == code block name ===[
statement1
...
statementn
! ]=== code block name ===
```

This facilitates the isolation of the block by the look plus some editors support the search for the matching bracket by a shortcut (e.g.: `ctrl +]` in Microsoft Visual Studio)

Comment the end of 'if' statements if there are many code lines between `if` and `endif` as follows:

```
if condition1 then
    ...
    if condition2 then
        ...
        ! many statements
    endif ! if condition2
endif ! if condition1
```

Some script types (Forward and Backward Migration Scripts especially) have a recommended form of separators and structures. For examples, see the ARCHICAD library or the section called “Basic Technical Standards”.

Script structure

Set your editor to use 4 character wide tabs. Spaces should never be used to tabulate lines. Instead, use spaces to adjust expressions to each other inline.

The maximum length of the lines is 120 characters. Statements shouldn't even get close to this number. In case they do, you get a warning.

All file name references are case sensitive in scripts, the extensions accordingly.

Values used multiple times should be calculated directly before the block of usage if it can be well localized or at the beginning of the script otherwise. There is no compromise. Calculate complex values only once to spare calculation time by storing them in variables (but do not waste variables unnecessary) or in the transformation stack (add, rot, etc.).

The object scripts are linear which makes them clearer. Subroutines should only break it when a calculation or model generation segment is needed more than once, or for script readability. Avoiding coding the same thing twice is an important principle in all programming languages. Redundancy makes later changes a lot more difficult.

Try not to use huge choice branches, instead prepare the data for a calculation or generation command in smaller choice-blocks, where you can avoid redundancy easier.

Bad Solution

```
if bOnHomeStory then
  line_type ltContour
  fill_gs fill_type
  poly2_b 5, 3, gs_fill_pen, gs_back_pen,
    left, 0, 1,
    left, -depth, 1,
    right, -depth, 1,
    right, 0, 0,
    left, 0, -1
endif
if (bOnUpperStory or bOnAboveUpper) and bDrawContBB then
  line_type ltBelow
  fill_fillTypeBelow
  poly2_b 5, 3, fillPenBelow, fillBackBelow,
    left, 0, 1,
    left, -depth, 1,
    right, -depth, 1,
    right, 0, 0,
    left, 0, -1
endif
```

The definition of geometry is duplicated! It could be even worse if the distance between the identical commands were bigger.

Good Solution

```

if bOnHomeStory then
  bPolygon = 1
  line_type ltContour
  fill_gs_fill_type
  fillPen = gs_fill_pen
  fillBGPen = gs_back_pen
endif
if (bOnUpperStory or bOnAboveUpper) and bDrawContBB then
  bPolygon = 1
  line_type ltBelow
  fill_fillTypeBelow
  fillPen = fillPenBelow
  fillBGPen = fillBackBelow
endif
if bPolygon then
  poly2_b 5, 3, fillPen, fillBGPen,
  left, 0, 1,
  left, -depth, 1,
  right, -depth, 1,
  right, 0, 0,
  left, 0, -1
endif

```

Prepare your scripts for localization.

Use "asdf" for non-localized strings (e.g. macro calls) and `asdf` for localized strings (e.g. string constants, parameter values).

BASIC TECHNICAL STANDARDS

Introduction

The release of new ARCHICAD® national versions, the growing GRAPHISOFT® product line and the BIMcomponents® portal have dramatically increased the demand for GDL objects and object libraries. As a result, many independent or third party GDL programmers have started developing libraries or objects for GRAPHISOFT.

Basic guidelines are necessary to keep these objects compatible and to achieve the standard of quality people expect from GRAPHISOFT products. The purpose of this document is to provide guidance to GDL developers in creating objects, with useful tips and tricks, examples, descriptions of previously undocumented and new ARCHICAD features.

Library part format

File extension

Most GDL Library Objects are saved with the *.gsm extension and they are distinguished by their subtype in ARCHICAD. There is a special extension, *.gdl (GDL Script Files) for the MASTER_GDL/MASTEREND_GDL files. ARCHICAD handles any GDL Script File starting with the string "MASTER_GDL..." or "MASTEREND_GDL..." in their file name in a special way. These files can be used to load attribute definitions, define line types, and materials etc. (more information in **The GDL Script Analysis on page 10**).

Identification

The identifier

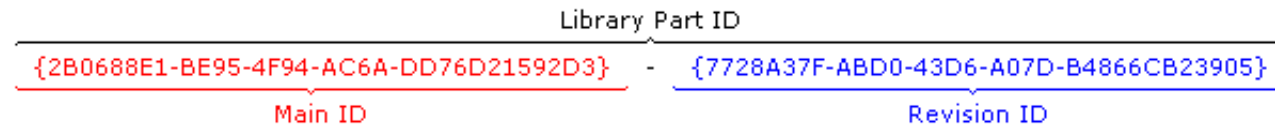

The ID consists of two parts, each 36 hexadecimal characters long. The first 36 characters represent the **Main ID** and the last 36 characters represent the **Revision ID**.

- The Main ID is created when the library part is saved for the first time. It is also modified if the library part is resaved using the "Save as" command.
- The Revision ID is also created when the library part is saved for the first time but it is modified if the library part is resaved using the "Save" command. Using the LP_XMLConverter tool a compilation will change the Revision ID and leave the Main ID untouched, of course.

This means that Main ID identifies a library part in its function and the Revision ID helps in distinguishing the revisions of the object. Let's see this in practice.

Library Part Identification

When placing an object in ARCHICAD, the program stores the reference by the ID and considers the name only for objects without an ID (library parts saved before ARCHICAD 8 and .gdl files). In case of Library Parts coming from versions earlier than ARCHICAD 8, there was no such thing as a GUID. So when such a Library Part is encountered in the file, ARCHICAD will fill out its ID with zeros.

When loading a library, ARCHICAD uses the following hierarchical criteria for matching loaded library parts to objects already placed in the project:

- In case the stored ID is valid:
 - ARCHICAD tries to get an exact match of both parts of the ID
 - Failing that, ARCHICAD tries to match the first part of the ID, which is the Main ID.
 - In case it doesn't find one matching, it starts to check other elements' Migration Table values to find a substitute.
 - Finally, when loading files saved before ARCHICAD 12, ARCHICAD tries to match by library part name.
- In case the stored ID is zero, the identification procedure tries to match by name only.

The same process is executed when looking for macros in a placed element as every library part contains a lookup table for its called macros' GUIDs. Naturally, when saving an object containing macro calls, this table is collected using a name-based search in the currently loaded library.

How to know what the exact GUID of a Library Object is

For this you have to get to know the Subtype Hierarchy dialog window. In this dialog you can see the subtype hierarchy of the currently loaded library in a tree view. The main attributes - name, version, ID, file location, flags indicating if the object is template or placeable - of the selected library part are displayed in the bottom of the window.

This dialog appears in 3 contexts:

- Open Object by Subtype... (in File menu)
- Select Subtype... (in the Library Part Editor window)
- Place All Objects (in the Special menu)

Naturally, you can read the ID in the XML format of the library part (location: `xpointer (/Symbol/@UNID)`). To get this, use the `LP_XMLConverter` tool.

Compatibility issues

The most important principle is that the Main ID represents a constant functionality to the users of the library. This means that if you publish a new library part using a Main ID that is already in use by an old library part, when loading an old project with the new library, the old placed elements will be replaced by the new object. This contradicts the users' expectations, such as there will be no change in the object's parameters and their functions. If you want to change the name or the function of old parameters, generate a new Main ID and use migration scripts to avoid ambiguity and unexpected data loss. Make sure that this new Main ID is unique - not identical with any other ID in the library.

Note, that renaming an object won't make it incompatible with its past self for ARCHICAD as long as their MainIDs remain identical. Similarly, giving the name of an existing library part to a new one (with a new ID) will not make them compatible.

This issue effects the localization of libraries, too. If you have string type controlling parameters, the relevant values will differ between national versions. For example: if you are unaware of the problem, loading a German plan file with the Danish sibling library will change the generated

elements since some control parameters have meaningless values. There are two solutions. The easy way is to declare that the German and Danish libraries have nothing to do with each other and to change the Main IDs in localization consequently. The second - and more user friendly - solution is to create an integer type control parameter acting as string (see VALUES). These integer parameters are determinant, the visible string descriptions are just an input method for them (therefore localizations can be different, but the true meaning will stay the same). When writing a script, the integer parameter values should be used.

The following example code features a detail level integer parameter acting as a string type:

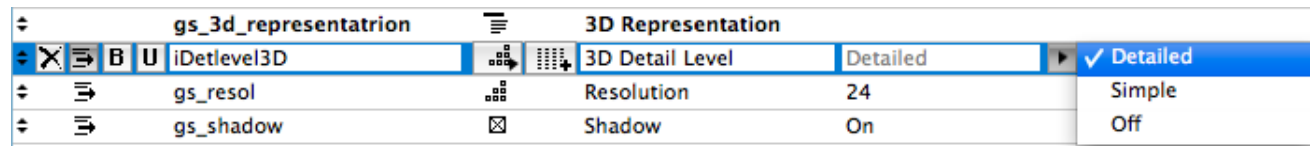

```
! Master script:
dim stDetlevel3DDesc [3]
stDetlevel3DDesc[1]=`Detailed`
stDetlevel3DDesc[2]=`Simple`
stDetlevel3DDesc[3]=`Off`

! iDetlevel3D constants
DETLEVEL3D_DETAILED = 1
DETLEVEL3D_SIMPLE   = 2
DETLEVEL3D_OFF      = 3

! Parameter script:
values{2} "iDetlevel3D"  DETLEVEL3D_DETAILED, stDetlevel3DDesc[1],
                        DETLEVEL3D_SIMPLE,   stDetlevel3DDesc[2],
                        DETLEVEL3D_OFF,      stDetlevel3DDesc[3]
```

Migrating Elements

It is possible to maintain a link between the old and the new, updated version (with new Main ID) of a library part by using migration scripts (the section called “Forward Migration script”, the section called “Backward Migration script”) and the section called “Migration table”.

In these scripts you can define which library part substitutes which (by connecting the old and new Main ID-s), and how to update the new object's parameter values based on the old one (or vice versa). You can set rules for the migration to happen only under certain parametric conditions. If the subject of the migration meets these, the upgrade or downgrade is possible, otherwise it will not be an option.

Generally, it is possible for the subject of the migration to have one or more successors (or ancestors in backward migration) depending on parameter settings. The case is a little different when migrating Zone Stamps, though. One type of Zone Stamp can be linked to many Zone Categories. But each category can use only one kind of Zone Stamp. When migrating a Zone Stamp, the Category stays the same. If the route of migration diverges ("Zone Old" is upgraded to "Zone New 1", or to "Zone New 2", depending on different parameter settings), it is possible to get a Category with two different Stamps linked. While this is a valid result regarding the migration process, it is an inconsistent situation for ARCHICAD. Make sure you only migrate Zone Stamps in a direct way, to avoid this.

General scripting issues

Numeric types - Precision

Before ARCHICAD 9 all numeric values were stored internally as floating point values which resulted in imprecise values. This meant that integer values were - a little - imprecisely stored. From ARCHICAD 9 integers - and hence GDL parameter types that are best described with integers - are correctly stored internally as integers.

Parameter types internally stored as an Integer:

- Integer,
- Boolean,
- Material,
- Line type,
- Fillpattern,
- Pencolor,
- Intensity (Light)

Parameter types internally stored as a Floating-point number:

- Length,
- Angle,
- Real,
- RGB Color component (Light)

GDL variables still don't require type definition, the type is determined during the interpretation from the value to be loaded into the variable. The output of numeric operators now have a type. You should consult the GDL Manual for this information.

The programmer can safely compare integer types with the equality operator. In fact, from ARCHICAD 9 warnings are now issued, if a programmer tries to directly compare floating point values with integer values using the equality operator. For equality-comparisons of floating-point numbers use a small epsilon value meaning the precision of the comparison. For equality-comparisons of a floating-point number and an integer use the `round_int` function.

Below some sample methods of testing for equivalence between different numeric types are described:

```
iDummy = 1 * 2
if iDummy = 2 then
    ! valid comparison, it is true, these statements will be executed
    ...
endif
```

```
dDummy = 1.5 + 0.5
if dDummy = 2 then
    ! you never know if it is true, don't trust such comparisons
    ...
endif
```

```
dDummy = 1.1 * 2
if dDummy = 2.2 then
    ! you never know if it is true, don't trust such comparisons
    ...
endif
```

```
! EPS = 0.0001 -> in the master script
dDummy = 1.1 * 2
if abs (dDummy - 2.2) < EPS then
    ! valid comparison, it is true, these statements will be executed
    ...
endif
```

```
dDummy = 1.5 * 2
if round_int (dDummy) = 3 then
    ! valid comparison, it is true, these statements will be executed
    ...
endif
```

Trigonometry functions

While GDL scripting, you may need various trigonometry functions. The following functions are directly available from GDL: `cos`, `sin`, `tan`, `acs`, `asn`, `atn`.

All other functions can be easily derived as follows.

```

Secant Sec(X) = 1 / cos(X)
Cosecant Cosec(X) = 1 / sin(X)
Cotangent Cotan(X) = 1 / tan(X)
Inv. Sine Arcsin(X) = atn(X / Sqr(-X * X + 1))
Inv. Cosine Arccos(X) = atn(-X / sqr(-X * X + 1)) + 2 * atn(1)
Inv. Secant Arcsec(X) = atn(X / sqr(X * X - 1)) + sgn((X) - 1) * 2*atn(1)
Inv. Cosecant Arccosec(X) = atn(X / sqr(X*X - 1)) + (sgn(X) - 1) * 2*atn(1)
Inv. Cotangent Arccotan(X) = atn(X) + 2 * atn(1)
Hyp. Sine HSin(X) = (exp(X) - exp(-X)) / 2
Hyp. Cosine HCos(X) = (exp(X) + exp(-X)) / 2
Hyp. Tangent HTan(X) = (exp(X) - exp(-X)) / (exp(X) + exp(-X))
Hyp. Secant HSec(X) = 2 / (exp(X) + exp(-X))
Hyp. Cosecant HCosec(X) = 2 / (exp(X) - exp(-X))
Hyp. Cotangent HCotan(X) = (exp(X) + exp(-X)) / (exp(X) - exp(-X))
Inv. Hyp. Sine HArcsin(X) = log(X + sqr(X * X + 1))
Inv. Hyp. Cosine HArccos(X) = log(X + sqr(X * X - 1))
Inv. Hyp. Tangent HArctan(X) = log((1 + X) / (1 - X)) / 2
Inv. Hyp. Secant HArcsec(X) = log((sqr(-X * X + 1) + 1) / X)
Inv. Hyp. Cosecant HArccosec(X) = log((sgn(X) * sqr(X * X + 1) + 1) / X)
Inv. Hyp. Cotangent HArccotan(X) = log((X + 1) / (X - 1)) / 2

```

Note:

Logarithm to base N $\text{LogN}(X) = \log(X) / \log(N)$

GDL warnings

Like any other programming language, GDL has a syntax and logic to be followed. If there is a mistake in syntax, the programmer gets an error message. If there is something confusing, or some unexpected thing happens when running the script, a GDL warning is sent out.

You can choose WHERE you want to send these messages in Options/Work Environment/Model Rebuild Options:

- **Interrupt with error messages:** a dialog pops up at every problem
- **Write Report:** the message is written in the Report window

You can choose WHAT you want to send out as message: this setting is available in the Library Developer menu, called "**Check Library Part Scripts for Warnings**". When enabled, not only errors, but warnings get reported as well according to the WHERE settings.

You can also choose WHEN you want to see warning messages. This can be set in the Library Developer menu as well, called "**Always Send GDL Messages**". Turning this feature on, every time GDL is executed, the warnings and errors get force-reported anyway. Leaving it off, the warning report contexts stay as usual.

Note, that using some combinations of the above switches can result in difficulties: for example, having the "**Always Send GDL Messages**" and the "**Interrupt with error messages**" enabled together may prevent the execution of something as "simple" as moving an editable hotspot, popping up dialogs all the time.

Pressing "**Check script**" in the library part editor, if there is a problem with your script using the current parameter settings, you will always get a warning or error message popup window. Using the PRINT command, or the GDL debugger may help a lot locating mistakes hard to find otherwise.

Note that the line numbers in the GDL warnings refer to the script which contains the problem.

Parsing errors must be handled with extra care. These denote the first line in which the parsing gets impossible but the actual problems may be some lines before.

Example

The interpreter detects the missing statement first at the `endif` and stops there; though the problem is obviously around line 4 where an `endif` is really missing.

```
if condition1 then
    if condition2 then
        ! do something

        ! do something - BUT WE MISSED AN 'endif'
    else
        ! a potentially long code block
    endif
```

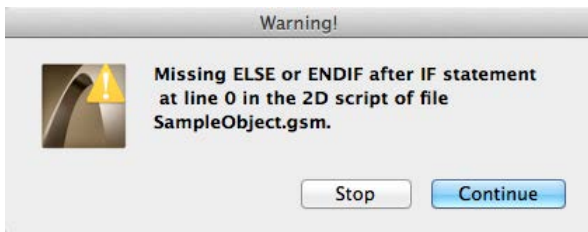

Here are some examples of the latest warning messages developed, with some explanation:

Warning message	Possible explanation
Simple parameter redeclared as an array	specifying a simple parameter in an object and using it as an array in the called macro
Undefined parentId "id" used in UI_PAGE definition	missing parent ID in tabpage hierarchy
View/Project dependent global "globalName" used in parameter script	see the section called "Global Variables"
Request "requestName" used in parameter script	see the section called "REQUEST Options"
Application query "applicationQueryName" used in parameter script	see the section called "Application Query Options"
Possibly unwanted parameter type change	a parameter receives a value not supported by its original type

Hotspot and Hotline IDs

Purpose of hotspot/hotline/hotarc identification

In ARCHICAD the hotspot/hotline/hotarc identification is introduced to support associative dimensioning in section. Via this feature a dimensioning item can refer to any of a GDL object's hotspots/hotlines. It will become an important issue when the number of hotspots/hotlines changes between the object's different parameterization states.

Problem of old-school hotspots/hotlines

If the programmer doesn't specify hotspot/hotline/hotarc IDs - or if he sets them to 0 - ARCHICAD will assign continuously increasing ordinal numbers. This solution is correct for static objects but causes dimensioning problems when some hotspots/hotlines appear or hide between parameter set-ups. Namely, the IDs will be rearranged so they will change, and the associative dimensioning items - in section - will go astray.

Correct hotspot/hotline/hotarc scripting

For all these reasons you should assign fix IDs to the hotspots/hotlines in your objects. This can be done by reserving wide intervals for the hotspots/hotlines of individually controllable features.

Let's take a stair for example. The bounding hotspots/hotlines may use the [1-100] interval, the handrails may use the [200-299] interval and the risers the [1000-) one. This guarantees that the dimensioning of the handrails won't be corrupted if the number of risers changes or even if the bottom connection gets more complex (using more hotspots/hotlines).

Editable hotspots

Since ARCHICAD 8 release you can use editable hotspots in your library parts. The feature is described in *Graphical Editing Using Hotspots* except for one possibility.

In some cases you may want to display a different parameter from the edited one. See the example code below:

Editable hotspot example - Shoe / Shoe-rack

We want to have the size of a shoe in meters and in shoe sizes, too. For that we create two parameters and connect them in the parameter script. Naturally, the type of the explaining parameter can be different (e.g. text). We emphasize that the edited parameter is `footLength` all the way, `footSizeEU` - the displayed parameter - must be updated via the parameter script.

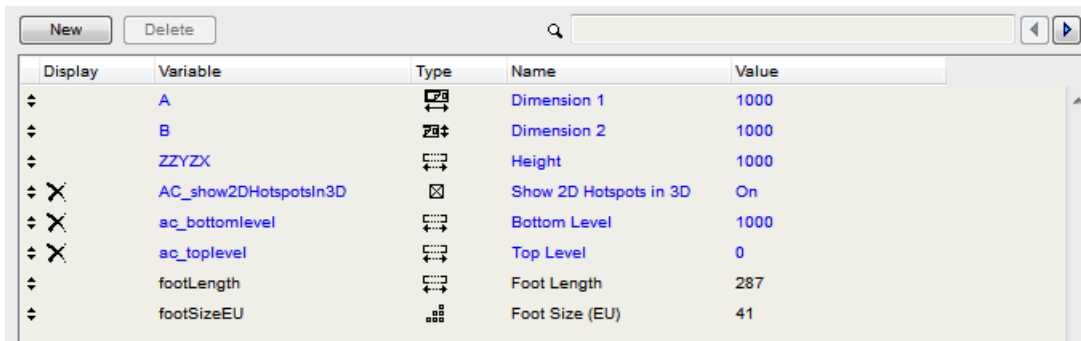

Display	Variable	Type	Name	Value
↕	A	↔	Dimension 1	1000
↕	B	↕	Dimension 2	1000
↕	ZZYZX	↕	Height	1000
↕ ✕	AC_show2DHotspotsIn3D	☒	Show 2D Hotspots in 3D	On
↕ ✕	ac_bottomlevel	↕	Bottom Level	1000
↕ ✕	ac_toplevel	↕	Top Level	0
↕	footLength	↕	Foot Length	287
↕	footSizeEU	☐	Foot Size (EU)	41

2D editing

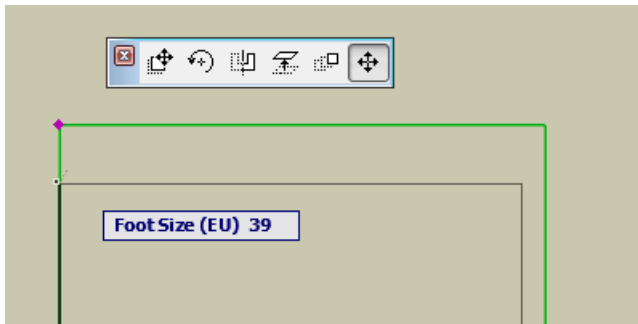

Parameter script

```
DIM lengthValues[10]
DIM sizeValues[10]
for i = 1 to 10
    sizeValues[i] = i + 35
    lengthValues[i] = (i + 35) * 0.007
next i

values "footLength" lengthValues
values "footSizeEU" sizeValues

if GLOB_MODPAR_NAME = "footLength" then
    parameters footSizeEU = round_int (footLength / 0.007)
else
    if GLOB_MODPAR_NAME = "footSizeEU" or GLOB_MODPAR_NAME = "" then
        parameters footLength = footSizeEU * 0.007
    endif
endif
```

2D script

```

rect2 0, 0, footLength * 0.4, footLength ! or a more realistic shoe model
hotspot2 0, 0, 1, footLength, 1 + 256, footSizeEU
hotspot2 0, footLength, 2, footLength, 2, footSizeEU
hotspot2 0, -0.1, 3, footLength, 3

```

GDL execution contexts

ARCHICAD lets the GDL object know about the context it is being displayed or used in. The next global variables are used for this purpose:

- **GLOB_VIEW_TYPE** to determine the active view
- **GLOB_PREVIEW_MODE** to determine the active preview
- **GLOB_FEEDBACK_MODE** for editing context indication
- **GLOB_SEO_TOOL_MODE** for solid element operations context indication

For the possible values refer to the section called “General environment information” and the following list:

GLOB_VIEW_TYPE = 2 - 2D, floor plan

The model is displayed in the standard 2D floor plan. In a 3D script this means that the model is projected to 2D via the `project2D` command. This is the main use of an object - this 2D model must be always correct and efficient.

If **GLOB_FEEDBACK_MODE = 1** then the model is displayed via feedback lines on the 2D floor plan during the hotspot editing of the object. This model is drawn many times in a single second throughout the user interaction. This implies that the model should represent the essential parts of the object only. Note, that texts (generated by `text2` command) are not refreshed in feedback mode - since it would slow down the output.

GLOB_VIEW_TYPE = 3 - 3D view

The 3D model is displayed in the standard 3D model window or it is the source of photorealistic rendering. This view should omit internal details of the object, since these cannot be seen anyway. This is the second most important use of an object - the 3D model must be always correct and efficient. This target type demands correct outside look.

If **GLOB_FEEDBACK_MODE = 1** then the 3D model is displayed via feedback lines in the 3D model window during the hotspot editing of the object. This model is drawn many times in a single second throughout the user interaction. This implies that the model should represent the essential and visible parts of the object only.

GLOB_VIEW_TYPE = 4 - section or GLOB_VIEW_TYPE = 5 - elevation

The 3D model is displayed in a section/elevation window. For these views, the object should generate internal details which are unnecessary for every other view type.

If **GLOB_FEEDBACK_MODE = 1** then the 3D model is displayed via feedback lines in a section/elevation window during the hotspot editing of the object. This model is drawn many times in a single second throughout the user interaction. This implies that the model should represent the essential and visible parts of the object only.

GLOB_VIEW_TYPE = 6 - 3D document

The 3D model is displayed in an axonometric window as a drawing. This is used for documentation, dimensioning in 3D.

GLOB_VIEW_TYPE = 7 - detail drawing

The model is used in a detailed drawing window. The model can be more detailed than in other views consequently. The 2D and 3D models are not distinguished - that information can be derived from the script type.

GLOB_VIEW_TYPE = 8 - layout

The model is used in a layout window, with its print display. The model should show its printing look. The 2D and 3D models are not distinguished - that information can be derived from the script type.

If **GLOB_FEEDBACK_MODE = 1** then the model is displayed via feedback lines in a layout window during the hotspot editing of the object. This model is drawn many times in a single second throughout the user interaction. This implies that the model should represent the essential and visible parts of the object only.

GLOB_VIEW_TYPE = 9 - calculation and/or GLOB_PREVIEW_MODE = 2 - listing

The 3D model is used for surface and volume calculation by the listing engine. This context is the proper place to do some model alterations for listing. E.g. you can generate extra bodies to raise the surface to be painted and the amount of required paint. Use the combination of the 2 globals for the desired result in calculation and listing model generation.

GLOB_PREVIEW_MODE = 1 - settings dialog

The model is displayed in the Object Settings Dialog's preview box. The 2D and 3D models are not distinguished - that information can be derived from the script type. The object should provide a fast, rough preview of the model considering the limited size of the preview.

GLOB_SEO_TOOL_MODE = 1 generating as an operator for Solid Element Operations

The generated 3D model is used as a parameter for solid (CSG) operations. This can be useful, when the object's space demand is larger than the object itself. E.g. when you subtract a stair from a slab, you'd expect that the stair cuts a hole for the walking people, too. To achieve this, in this context the stair should generate a model containing that walking space.

Communicating values with ARCHICAD

There are two directions of parameter value flow between ARCHICAD and the library part. The first direction means that the ARCHICAD informs the library part about an attribute of its context (e.g. the drawing scale of the project or the thickness of the wall a window is placed into). The second direction is when the library part asserts something about itself which instructs ARCHICAD to change that something in the direct context of the object (e.g. the depth a wall end cuts in the wall).

Information flow from ARCHICAD

There are 3 channels of information coming from ARCHICAD: global variables, parameters with predefined names and directly called values.

Global variables

Global variables are filled by ARCHICAD according to the current project settings and to the placement context of the object. Note, that not all globals are filled in every context and view.

For the complete list of global variables and their relevant restrictions in certain scripts, consult the section called “Global Variables”.

Fix named optional parameters

The newer method of ARCHICAD for providing information is the method of fixed named optional parameters. If a given library part has a parameter with a name and type matching any optional parameter, ARCHICAD sets its value according to its function.

Refer the section called “Parameters set by ARCHICAD” in the section called “Fix named optional parameters” to learn the ARCHICAD defined library part parameters.

Requests and Application Queries

For rarely used, special information, library parts use Request calls or Application Queries in their scripts. Unlike global variables, these only give a return value when the containing actual scripts runs. Note, that most requests and queries should be avoided in a parameter script, or a master script run as a parameter script. If used in those scripts, the validity of the returned value or the function can not be guaranteed.

Refer the section called “REQUEST Options” and the section called “Application Query Options” to learn more about options, parameter script compatibility and syntax.

Information coming from the library part

ARCHICAD needs certain informations to use the library parts correctly. These informations depend on the function and the context, and are stored in the built-in ARCHICAD subtypes as parameters with predefined name and function. In addition to built-in ARCHICAD subtypes some functions might need fixed named optional parameters.

Consult the fix parameters of built-in subtypes and the section called “Parameters read by ARCHICAD” in the section called “Fix named optional parameters” to get a view of the possibilities.

Model View Options, Library Global

The display of library parts in the plan may depend on the current view.

Internal Model View Options

The view's internal settings are available via GDL global variables (e.g. GLOB_SCALE, GLOB_STRUCTURE_DISPLAY) and request options (e.g. "window_show_dim", "door_show_dim", "floor_plan_option", "view_rotangle").

Library Global View Options

From ARCHICAD 13 on, you can define view options from your library. These options are stored into each view and they are returned accordingly.

The following properties/parameters/options should be stored in view dependent library globals:

- showing/hiding opening lines
- showing/hiding minimal spaces
- pen and other view attributes which shouldn't be changed individually for the sake of uniformity (e.g. minimal spaces)
- showing/hiding specific accessory elements (e.g. knobs, handles)
- setting 2D symbol types for object groups

Things which should NOT be stored in view dependent library globals: general values for the whole project, general values for the whole country, values which may be required to be set individually for objects.

To insert a tab page into the MVO dialog, you have to make a library part which is derived from the *Library Global Settings* (GUID: {709CC5CC-6817-4C56-A74B-BED99DDB5FFA}) subtype. This object must contain the desired global options as parameters and it must have a user interface definition for the tab page. The width of the UI should be set to 600 pixels to match the existing panels. The height of the UI is freely definable. It may have a parameter script for connecting parameters or user interface elements.

The LIBRARYGLOBAL command can be used in your placeable elements to query values of your own library global settings object depending on the current view settings.

Script type specific issues

Master script

When writing the master script you should keep in mind that it will be evaluated before the run of each script by ARCHICAD. This implies the following things:

- Placing parameter definitions and calculations used by multiple scripts in the master script is a good idea: it reduces file size and makes elements easily modifiable.
- Be sure to put only common calculations here to avoid an unnecessary increase of the evaluation time of the libpart (remember that master script is evaluated before each and every script).

- Avoid using the parameter buffer in the master script for effectiveness reasons.
- Do not put end commands in the master script; otherwise, ARCHICAD will not run the rest of the scripts.

2D script

Execution context

The 2D script is executed when a 2D model is generated:

- 2D plan
- 2D editing feedback
- 2D preview in the Object Settings dialog window
- Layout drawing
- Layout drawing feedback

Mind that most of the architectural design is done in 2D, so usually this model is the most important. This implies requirements of exact look, fast generation time and proper function when editing via hotspots.

General recommendation

Try to avoid using fragments and the binary 2D format in order to make objects modifiable.

2D script is much more customizable than the 2D symbol, prefer this solution. In a binary 2D symbol, the curved fills aren't stretched correctly, you don't have to face this problem in 2D scripting, either.

Defining line and fill properties

From ARCHICAD 9 on you have the possibility to choose from several main categories of lines and fills from GDL. Lines and polygon segments can be defined as contour, inner or general; fills can be defined cut, cover or drafting. These categories are described in the ARCHICAD user documentation, let's see how we use them in GDL objects.

Setting the correct properties for lines and fills will enable you to eliminate the display-option dependence from your scripts. Formerly, you had to add a condition for drawing of some inner lines according to the set display option. Now you should define an inner line for that purpose and ARCHICAD will display it or not as implied by the display options.

Let's see the extract of the 2D script of a window to summarize the definition cases:

```
! ===== Sill =====  
  
line_property 0    ! general lines  
  
! the sill is seen from above -> cover fill  
poly2_b{2} 4, 1 + 2 * (gs_fillSillCover > 0) + 4 + 64, ...  
...  
  
! ===== Wall segment / Cavity Closure =====  
  
line_property 1    ! inner lines  
line2 ...  
...  
  
line_property 2    ! wall contours  
line2 ...  
...  
  
! wall segment is seen cut -> cut fill  
poly2_b{2} 4, 2 + 4 + 8 + 16 + 32, ...  
  
! ===== Window Frame =====  
  
line_property 0    ! general lines  
  
! side window frame is seen cut -> cut fill  
poly2_b{2} 4, 1 + 2 * (gs_fillFrames > 0) + 4 + 32, ...  
...
```

3D script

Execution context

The 3D script is executed each time a 3D model is generated:

- 3D window (wire, hidden line, solid model)
- 2D plan when `project2` is used to project the 3D model to 2D

- 2D section - mind the details
- 3D editing feedback - optimize for speed
- Operator for solid operations in 3D - ask the designer for the desired functionality
- Surface and volume calculation for Listing
- 3D preview in the Object Settings dialog window
- Layout drawing when `project2` is used to project the 3D model to 2D
- Layout drawing feedback

General recommendation

Try to avoid using binary format in order to make objects modifiable.

Use status codes to control the visibility of the objects in hidden line views. Make the contour lines of curved surfaces visible. Hide unnecessary lines when it is possible.

Define editable hotspots instead of fix ones whenever possible.

Don't use `del top` command to make later modifications easier.

Always restore the global coordinate system at the end of the 3D script and follow it with an `end` command to make further modifications on the object easier.

Modeling transparent bodies

Use the `body -1` command between solid and transparent parts of an object to make correct shadow casting with Internal Rendering Engine (e.g., window sash with grilles).

Table 7. Examples for transparent bodies

Incorrect

```
prism_10, 0.1,
  0, 0, 15,
  1, 0, 15,
  1, 1, 15,
  0, 1, 15,
  0, 0, -1,
  0.1, 0.1, 15,
  0.9, 0.1, 15,
  0.9, 0.9, 15,
  0.1, 0.9, 15,
  0.1, 0.1, -1
```

```
material "blueglass"
```

```
prism_5, 0.1,
  0.1, 0.1, 15,
  0.9, 0.1, 15,
  0.9, 0.9, 15,
  0.1, 0.9, 15,
  0.1, 0.1, -1
```

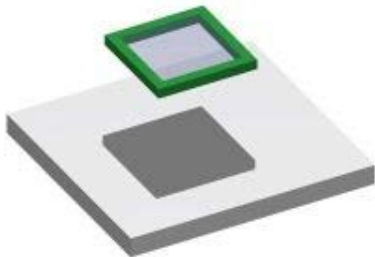
**Correct**

```
prism_10, 0.1,
  0, 0, 15,
  1, 0, 15,
  1, 1, 15,
  0, 1, 15,
  0, 0, -1,
  0.1, 0.1, 15,
  0.9, 0.1, 15,
  0.9, 0.9, 15,
  0.1, 0.9, 15,
  0.1, 0.1, -1
```

```
body -1
```

```
material "blueglass"
```

```
prism_5, 0.1,
  0.1, 0.1, 15,
  0.9, 0.1, 15,
  0.9, 0.9, 15,
  0.1, 0.9, 15,
  0.1, 0.1, -1
```

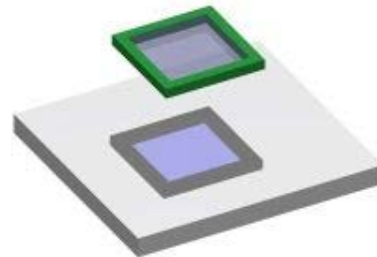

Texture mapping

Always check if texture mapping is applied correctly on your objects. If the default ARCHICAD texture mapping process doesn't produce a good result, use the `COOR` command to set the correct method. See the case below for example.

Table 8. Example code for random and for correctly aligned tiling

Random texture

```

define texture "owntile" "T.jpg",
    1, 1, 128+256, 0

define material "tilemat" 21,
    0.7, 0.7, 1,
    0.15, 0.95, 0, 0.0,
    0, 0,
    ind (fill, ""), 1,
    ind (texture, "owntile")

material tilemat

block 1, 1, 1

```

**Aligned texture**

```

define texture "owntile" "T.jpg",
    1, 1, 128+256, 0

define material "tilemat" 21,
    0.7, 0.7, 1,
    0.15, 0.95, 0, 0.0,
    0, 0,
    ind (fill, ""), 1,
    ind (texture, "owntile")

material tilemat

block 1, 1, 1

base
vert 0, 0, 0
vert 1, 0, 0
vert 0, 1, 0
vert 0, 0, 1

coor 2 + 256, -1, -2, -3, -4

```

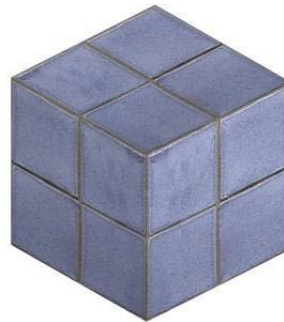

In general, separate bodies which require different texture coordinate systems with a `body -1` command.

When using different texture mapping modes, you should take care of correct axis definitions with the `vert` or `teve` commands. The node order is shown below.

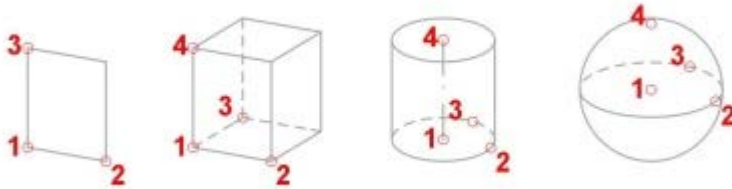

You can distort the textures by setting different distances between the nodes defined by the `vert` or `teve` commands.

Take care that working with different rendering engines can produce slightly different results, see the examples.

Internal engine:

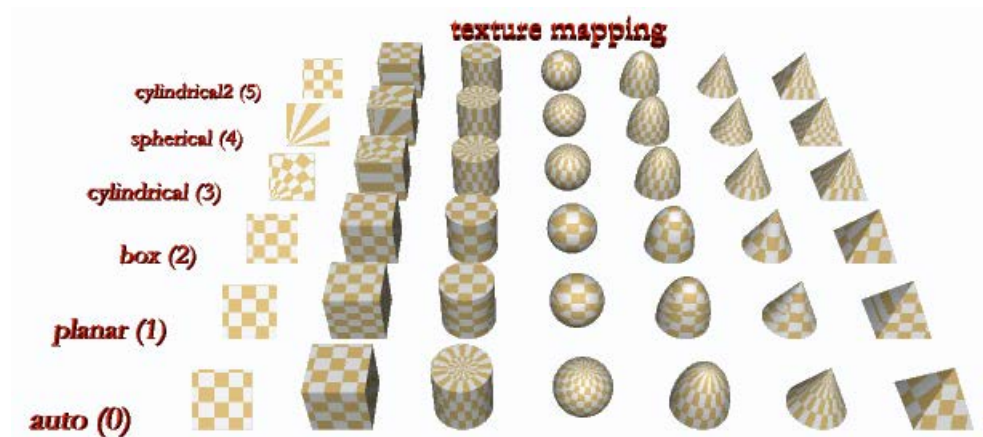

C4D engine:

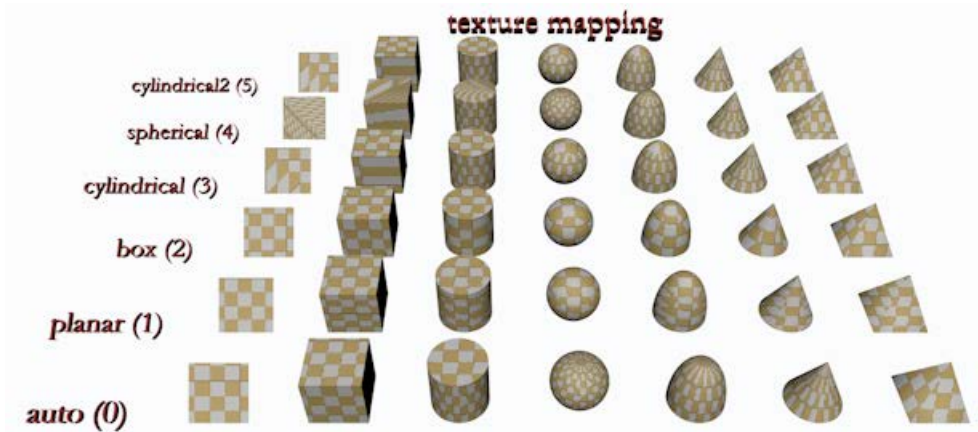

Correct texture mapping on complicated surfaces or distorted textures can be modeled with `cor` and `teve` commands. In this way you can make surface models only. In ARCHICAD, there is no direct texture specification. You can define a texture as a part of a material definition. This texture is used in Rendering Engines and in OpenGL – but in OpenGL we have only limited implementation of our full texture mapping, and no texture (fill) mapping in our Internal 3D Engine at all.

So with `TEVE` command you can map a planar texture point (u,v) to a spatial geometric point (x, y, z) :

- (x, y, z) is measured in meters in the local coordinate system, as usual
- (u, v) is measured in units in the infinite texture space. One unit is as long as the texture extent in that direction.

You can give a negative or more than one value for either u or v .

See the example 1:

Table 9. Teve example 1: mapping with no distortion

Program

```

base
teve 0, 0, 1, 0, 0
teve 2, 0, 1, 1, 0
teve 0, 2, 1, 0, 1
teve 2, 2, 1, 1, 1
teve 0, 0, 1, 1, 1

edge 1, 2, -1, -1, 0
edge 2, 4, -1, -1, 0
edge 4, 3, -1, -1, 0
edge 3, 1, -1, -1, 0

set material 92

pgon 4, 0, 0, 1, 2, 3, 4
coord 1024, 1, 2, 3, -5

body -1

```

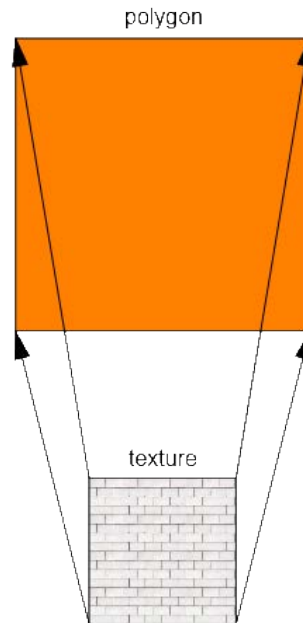
Logic**Result**

If you make a non-regular mapping, the Rendering engine will fit the shape in texture space to the shape in model space:

Table 10. Teve example 1: mapping with distortion

Program

```

base
teve 0, 0, 1, 0, 0
teve 2, 0, 1, 1, 0
teve 0, 2, 1, 0.3, 0.5
teve 2, 2, 1, 1, 1
teve 0, 0, 1, 1, 1

edge 1, 2, -1, -1, 0
edge 2, 4, -1, -1, 0
edge 4, 3, -1, -1, 0
edge 3, 1, -1, -1, 0

set material 92

pgon 4, 0, 0, 1, 2, 3, 4
coord 1024, 1, 2, 3, -5

body -1

```

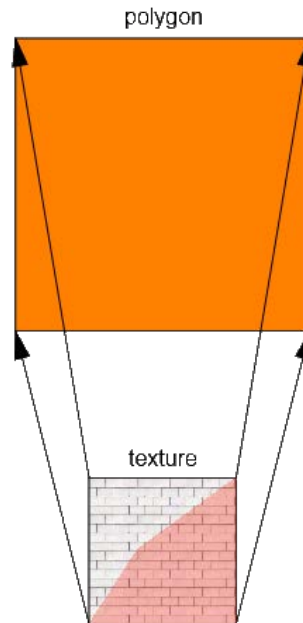
Logic**Result**

The same is true for real 3D bodies, as you can see in this example:

Table 11. Teve example 1: mapping with distortion on a pyramid

Program	Logic	Result
base		
teve 0, 0, 1, 0, 0 ! 1		
teve 2, 0, 1, 2, 0 ! 2		
teve 2, 2, 1, 2, 2 ! 3		
teve 2, 2, 1, 0, 2 ! 4		
teve 1, 1, 3, 1, 1 ! 5		
edge 1, 2, -1, -1, 0		
edge 2, 4, -1, -1, 0		
edge 4, 3, -1, -1, 0		
edge 3, 1, -1, -1, 0		
set material 92		
pgon 3, 0, 0, 1, 6, -5		
coord 1024, -6, -7, -8, -9		
body -1		

Please note, that you can assign only one texture vertex for a model vertex. It is not possible to assign the texture vertices on a per polygon basis. It is sometimes an advantage and sometimes a disadvantage.

Picture elements

It may be a good idea to replace complicated parts of a model with a single picture. This method can be well used for trees and bushes.

Using an external image referred by its file name, don't omit the file extension.

When you place a picture in a 3D model using the `picture` command, a polygon will be created using the picture as a face. The material of the polygon affects the result of the rendering. With this in mind you should use a matte surface - the color may be chosen depending on the picture.

```

define material "pictmat" 2,
    1, 1, 1          ! RGB

material "pictmat"

picture "filename.extension", a, b, mask

```

The first picture shows a picture on a shiny surface - the undesired side-effect can be observed. In the second picture you can see a texture on a precisely set material - the wanted result.

Table 12. Transparent images

Shiny surface



Matte surface



For transparent images - like the tree above - you should consider a more precise definition of the base material. See the following example.

```

define material "pictmat" 0,
    1, 1, 1,          ! RGB
    0.5, 0.8, 0, 0,
    0, 0,
    0, 0, 0,
    0, 0, 0,
    0

```

```

material "pictmat"

picture "filename", a, b, mask

```

Group operations

Group operations bring the power of solid operations into GDL. On the other hand they present a risk factor when misused.

An important point is that you mustn't place a group inside another one. In such situations you should define a new group like in the source snippet below:

```
subtractionResult = subgroup ("sub_operand_1", "sub_operand_2")
```

Parameter script

Execution context

The parameter script is run in the following cases:

- Opening the Object Settings dialog window
- Changing a parameter's value in the Object Settings dialog window
- Changing a parameter's value using editable hotspots (even while generating the feedback)
- Stretching the object using conventional hotspots
- loading step-by-step migration libraries (starting from AC18)

The parameter script MAY be run on:

- Dragging the object, in case the object refers to SYMB_POS_X/SYMB_POS_Y
- *Update Zones* runs the parameter script of the affected zones if necessary

The parameter script is NOT run on:

- Rebuild
- Changing scale
- Changing story

Editing multiple selection may result unintended parameter values.

Note that the parameter script may be run multiple times on a single user interaction. The reason for this is that the parameter script can change the value of parameters and this requires the parameter script to be run again, and so on. Therefore it makes no sense to increase a parameter value by one in the parameter script since you may not be able to predict the cardinality of executions.

The run of the parameter script is linear, and not necessarily multiple. You can force the parameter script to start only once by checking the **Run the parameter script only once** option in the object's Compatibility Options panel, if you are sure you don't need it to run many times. This can make objects react faster, saving time and computing resources.

General recommendation

When you control parameters in the parameter script, try to follow the order of additional parameters.

You can define relations between parameters using the `GLOB_MODPAR_NAME` value (containing the name of the last modified parameter). For example you can make a circle object for which both the radius and the diameter can be set (maybe one of them via the parameter list and the other via editable hotspots). Don't use this possibility to define the valid range of parameters - use `values` command instead.

Define the valid value range for all parameters using the `values` command.

When resetting the value of a parameter in a certain condition in the Parameter Script using the `parameters` command, a similar statement must be put into the Master Script. This keeps the object's display correct in cases when the parameter script is not run by the system. E.g.:

```
! parameter script
if bCondition then
    yy = 1
    parameters yy = yy
endif

! master script
if bCondition then yy = 1
```

Font type names

If you want to have a string parameter - named `stFont` in the sample - for setting the font type for a text, use the following value list definition to get a platform independent sound solution.

```
DIM fontNames[]
request ("FONTNAMES_LIST", "", fontNames)
values "stFont" fontNames, CUSTOM
```

If you do this in the `ARCHICAD_Library_Master.gsm` object, every loaded library part with the same `"stFont"` parameter will automatically receive the same value list.

`CUSTOM` value is needed to deal with missing or unexpected font types.

Setting limits for array parameters

Array parameters should be used for homogeneous data; i.e. all array elements should have a similar meaning.

Example code snippet for limiting all components of array parameter `gridXPosition` to the range [1, 5] and how to use it on the UI:

```
! parameter script
values "gridXPosition" range [1, 5]

! UI script
for i = 1 to nGridLines      ! nGridLines: number of lines in the array parameter
    ui_infield{3}    gridXPosition[i], xPos, yPos, infieldWidth, infieldHeight

    yPos = yPos + diffY
next i
```

User Interface script

Execution context

The User Interface script is displayed in only one context: the user interface tab page in the Object Settings dialog window.

The script is run on the initialization of the dialog window and after each user interaction and parameter change.

General recommendation

If you want the Custom Settings page to appear in the topmost UI selector as default instead of the parameter list, push the **Set as Default** button (or add the "STBit_UIDefault" bit to the "StatBits" section of the XML). Otherwise the parameter list will be the starting tab. For Hierarchical pages, push the **Hierarchical Pages** button in the GDL Editor/UI window (or add the "STBit_UIUseHierarchicalPages" bit to the "StatBits" section of the XML).

When styling texts, note that extra small letters cannot get any style but plain. In addition, *Outline* and *Shadow* styles have no effect on Windows platform.

Note that ARCHICAD tries to match the fonts used in dialogs with the operating systems. When scripting graphical user interfaces on Windows, leave more space around texts otherwise Mac users will see truncated texts.

Thumbnail control pictures

If you use the `ui_infield` command to define a thumbnail view field for value lists, be aware of the following. There should be equal sized thumbnails for all parameter values (including empty value). Thumbnails have to be the same size at which they will be displayed otherwise ARCHICAD will distort them. We advise you to use ARCHICAD's figure tool for assembling the thumbnails into one picture file.

Table 13. Infield with picture

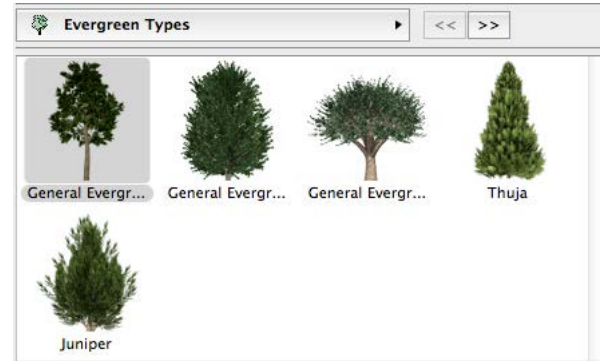
Input picture**Output picture**

A user interface picture used by only one object should be integrated in the library part file itself. This can be done using the LP_XMLConverter tool.

When using an external image referred to by its file name, don't omit the file extension. This way, you will avoid errors stemming from pictures and objects having the same name.

Keep all pictures used by interface scripts in the Macros folder, or embedded in the object itself. Using external images: add the `file_dependence` command to make sure they are saved in archive format with the object.

Tab page handling

Starting from ARCHICAD 18, a new hierarchical paging option is available for tabpage selection. This is accessed via the UI_PAGE command, by adding some extra parameters, and setting the **Hierarchical Pages** parameter in the object itself. Doing so, a separate popup tabpage control will appear above the custom UI field. The order and hierarchy of the available pages can be defined by the ID of the pages. Root ID is always -1. The possibility to set up an "oldschool" tabpage selector within the UI page still remains available.

Let's see an example script:

```
! Master Script

! TabIDs
TABID_ROOT      = -1
TABID_PAGE_1    = 50
TABID_PAGE_2    = 60

dim uiUsedPageIDs[][2]
dim uiUsedPageNames[][2]

idxPage = 1

uiUsedPageNames[idxPage][1] = "PageName_1"
uiUsedPageNames[idxPage][2] = "pageIconName_1.png"

uiUsedPageIDs[idxPage][1]    = TABID_PAGE_1
uiUsedPageIDs[idxPage][2]    = TABID_ROOT      ! Parent Page ID

idxPage = idxPage + 1

uiUsedPageNames[idxPage][1] = "PageName_2"
uiUsedPageNames[idxPage][2] = "pageIconName_2.png"

uiUsedPageIDs[idxPage][1]    = TABID_PAGE_2
uiUsedPageIDs[idxPage][2]    = TABID_PAGE_1    ! Parent Page ID

file_dependence "pageIconName_1.png"
file_dependence "pageIconName_2.png"
file_dependence "pageIconName_3.png"
```

```
! Parameter Script

dim pageValues[]
for i = 1 to vardim1(uiUsedPageIDs)
    pageValues[i]= uiUsedPageIDs[i][1]
next i

values "gs_ui_current_page" pageValues

! UI Script

ui_dialog "Custom Settings Title"
ui_current_page gs_ui_current_page

for i = 1 to vardim1(uiUsedPageIDs)
    if uiUsedPageIDs[i][1] = TABID_PAGE_1 then
        ui_page uiUsedPageIDs[i][1], uiUsedPageIDs[i][2],
            uiUsedPageNames[i][1], uiUsedPageNames[i][2]
        if gs_ui_current_page = TABID_PAGE_1 then
            gosub "pageSubroutinTitle_1"
        endif
    endif

    if uiUsedPageIDs[i][1] = TABID_PAGE_2 then
        ui_page uiUsedPageIDs[i][1], uiUsedPageIDs[i][2],
            uiUsedPageNames[i][1], uiUsedPageNames[i][2]
        if gs_ui_current_page = TABID_PAGE_2 then
            gosub "pageSubroutinTitle_2"
        endif
    endif
next i
```



```

! =====
! Call User Interface Macro's TabPages
! =====

call "ui_customMacro" parameters all      uiUsedPageIDs    = uiUsedPageIDs,
                                           uiUsedPageNames = uiUsedPageNames

! =====
end ! end ! end ! end ! end ! end ! end ! end ! end ! end ! end ! end ! en
! =====

! =====
! UI Page Subroutines
! =====

"pageSubroutinTitle_1":
    ! UI Page 1 description
return

"pageSubroutinTitle_2":
    ! UI Page 2 description
return

```

Thumbnail controls with dynamic items

From ARCHICAD 10 on, a new dynamic method is available for linking control items and value list items. Using this method you can localize the logic of the availability of parameter values to the parameter script - the control will adopt the set of available values. This dynamic linking is available for `ui_infield{3}` and `ui_infield{4}`. The old-style static linking is still working for static functions (using `ui_infield` and `ui_infield{2}`).

The two components of the dynamic method are:

1. Define the user interface control with an option for every possible value.

The example shows a popup menu control (method = 2) which uses an index image containing 2 rows and 4 columns. The sample control supports 8 possible values.

```
ui_infield{3} iJunctionType, xColumn1-10, 44, 200, 50,  
  2, 3, 8, 2,  
  70, 45, 70, 45,  
  1, `Junction Type A1`, 2,  
  2, `Junction Type B1`, 4,  
  3, `Junction Type C1`, 1,  
  4, `Junction Type D1`, 3,  
  5, `Junction Type A2`, 5,  
  6, `Junction Type B2`, 7,  
  7, `Junction Type C2`, 6,  
  8, `Junction Type D2`, 8
```

2. Set the list of available values for the parameter under the given circumstances.

```
if iLeftNeighbour = 1 then  
  values "iJunctionType" 1, 3, 4, 6  
else  
  if iRightNeighbour = 1 then  
    values "iJunctionType" 2, 5, 7, 8  
  else  
    values "iJunctionType" 1, 5, 7  
  endif  
endif
```

The resulting control is shown in the image below. (iLeftNeighbour = 0, iRightNeighbour = 1)

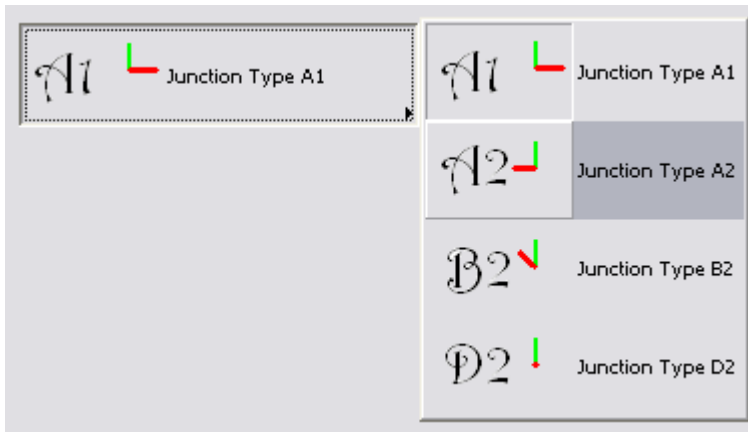

Transparent UI pictures

In ARCHICAD 10 a new method has been introduced that can handle alpha-layer based transparent pictures. The following controls handle pictures with alpha layers correctly:

- `ui_pict`
- `ui_infield{3}`, method = 1 (thumbnail view control)
- `ui_infield{3}`, method = 2 (popup with icons and texts)
- `ui_infield{3}`, method = 3 (popup with icons only)
- `ui_infield{3}`, method = 4 (icon radio push button)
- `ui_infield{4}`, method = 1 (thumbnail view control)
- `ui_infield{4}`, method = 2 (popup with icons and texts)
- `ui_infield{4}`, method = 3 (popup with icons only)
- `ui_infield{4}`, method = 4 (icon radio push button)

Font sizes on the UI

If you use static texts (possibly in combination with the `ui_style` command), be aware of the following.

Because of the differences of the targeted operating systems, font sizes are not the same on Windows and on Mac. As a side effect, the *extra small* font size is a bit larger than the *small* one on Windows. As a general rule, always test user interfaces on both platforms to check overlapping and clipping.

Furthermore, special styles like Bold, Italic and Underline are not allowed in combination with *extra small* size. Outline and Shadow are old Macintosh styles, which are no longer used.

The two pictures show the look of static texts with different sizes and styles.

On Windows:

	small	xsmall	large
normal	ui_style 0,0	ui_style 1,0	ui_style 2,0
bold	ui_style 0,1	ui_style 1,1	ui_style 2,1
italic	<i>ui_style 0,2</i>	ui_style 1,2	<i>ui_style 2,2</i>
underline	<u>ui_style 0,4</u>	ui_style 1,4	<u>ui_style 2,4</u>

On Mac:

	small	xsmall	large
normal	ui_style 0,0	ui_style 1,0	ui_style 2,0
bold	ui_style 0,1	ui_style 1,1	ui_style 2,1
italic	<i>ui_style 0,2</i>	ui_style 1,2	<i>ui_style 2,2</i>
underline	<u>ui_style 0,4</u>	ui_style 1,4	<u>ui_style 2,4</u>

Forward Migration script

Execution context

The FWM script is executed when a project saved in an earlier version of ARCHICAD is opened in a later version (starting with ARCHICAD 15) with the updated library. This new library can be loaded manually or by using the Consolidate option in the Library Manager. If a placed instance of an object has a new, changed Main ID and a valid Forward Migration Script in the new library, it can be automatically substituted by ARCHICAD. If the execution of the script is successful, the old element gets replaced by the new one.

This script enables the object to set the new parameters based on the old ones, without feature loss or a major change in appearance.

General recommendation

The first line of the script fills the FROM_GUID global variable (this contains the main ID of the original object to be migrated) into the "actualGuid" variable. You may want to use the following structure to ensure maintainability.

The rest of the script is divided into subroutine calls, one for every change of GUID. Every block must have a corresponding line in the Migration Table of the object and a block in the Backward Migration script. The latest change of Main ID always has to be the last call of this script. In every block you set the ID to start from (`_startID`), and the one to end up with (`_endID`), define the migration logic in a subroutine (for details and GDL commands, see the GDL Reference Guide), and at the end of the block you always set the new "`_endID`" (or set an empty ID, which means that the upgrade process will stop at the previous block's version of the object) into the "actualGuid" variable. Example:

```

actualGUID = FROM_GUID

! =====
! Subroutines
! =====

    _startID    = "AAAA-AAAA-...AAA"
    _endID      = "BBBB-BBBB-...BBB"
gosub "migrationstepname_FWM"

! =====
! Set Migration GUID
! =====

setmigrationguid actualGUID

! =====
end ! end ! end ! end ! end ! end ! end ! end ! end ! end ! end ! end ! end ! en
! =====

! =====
! migrationstepname
! =====
"migrationstepname_FWM":
    if actualGuid = _startID then
        newParameter = oldParameter
        parameters newParameter = newParameter
        actualGuid = _endID
    endif
return

```

Backward Migration script

Execution context

The BWM script is executed when a project is saved to the previous version of ARCHICAD. If the current version of the library part has a different Main ID than its equivalent in the previous version, the migration script of the object is evaluated. As a result, the libpart will be either downgraded if possible (sometimes with some minor compromise, if it does not affect the item's main functions), or will be lost completely

(in this case, it will appear as a "missing" dot sign in the earlier version project). The latter happens when a new function set introduced in the current version represents a major change compared to the previous version.

A successful backward migration process should convert the object's parameters in a way that avoids major feature loss or changes in appearance.

General recommendation

The first line of the script sets the continuity control variable to valid. You may want to use the following structure to ensure maintainability.

The rest of the script is divided into subroutines: one change of Main ID is one subroutine. Every subroutine must have a corresponding line in the Migration Table of the object and a corresponding subroutine in the Forward Migration script. The **latest step back** in changing Main ID always has to be the **first subroutine** of this script.

At the start of each subroutine the target GUID is checked. If not empty, the script runs in called order. Backward migration only works for one version back, so the targetGUID only needs to be set once (except when you make a fork in the migration to separate previous-version objects).

The end of the subroutine is about setting the destination (old) ID into the "targetGuid" variable. If you set an empty ID to the variable, the downgrade process is canceled there. If the "targetGuid" matches the TO_GUID global variable (containing the main ID of the target element in the conversion), the first part of the migration process is complete.

Adding a title or a short description of the migration step for every subroutine is highly recommended. You should use the same title for the Forward Migration script pair of the subroutine.

After you have reached the desired stage of the object's devolution, you have to set the placed object's ID by using the `setmigrationguid`. In case the migration returns an empty ID, the element is going to be missing from the project opened in the previous version.

```

targetGUID = TO_GUID

! =====
! Subroutines
! =====

gosub "migrationstepname_BWM"

! =====
! Set Migration GUID
! =====

setmigrationguid targetGUID

! =====
end ! end ! end ! end ! end ! end ! end ! end ! end ! end ! end ! end ! en
! =====

! =====
! migrationstepname
! =====
"migrationstepname_BWM":
  if targetGUID # "" then
    bMigrationSuccess = 1
    if bMigrationSuccess = 1 then
      oldParameter = newParameter
      parameters oldParameter = oldParameter
    else
      targetGuid = ""
    endif
  endif
return

```

Migration table

Every time you change an object's Main ID, you need to fill in the old ID into the Migration Table of the element. Each line contains a previous ID and an ARCHICAD version number (or 0, if you change more than once between two versions). During forward migration, the program scans this list of ID-s, preselecting the elements available for the migration process. During backward migration, scanning this list the program

chooses only those with a version equivalent to the previous ARCHICAD version. Every line of this table must have at least one corresponding subroutine in the Forward Migration script and the Backward Migration script.

Writing macros

Try to collect frequently used functionalities into macros. Calling a macro object from many objects can reduce library size and increase soundness by reducing redundancy.

However avoid creating macros with small functional addition to the previous abstraction level. For example don't create a `block_1x1x1` macro for the generation of a 1m x 1m x 1m block. This increases the number of macro calls needlessly and it may worsen transparency.

Don't ever use `.gdl` as macros, use macro objects instead.

When you call a macro, always use the `call` keyword and put the name of the macro between quotation marks (e.g, `call "m_rail_wired"`). Do not create macro calls where the macro name is a parameter to avoid missing macros from archive files. ARCHICAD saves the default macro only into the archive file. (Workaround: call all parameter values as a macro after the end statement.)

Be careful at using the parameter buffer. Save the content of it at beginning of the script if you want to use it. Be sure that only the defined (return) values are in the buffer by the end of the script.

Macro return parameters

From ARCHICAD 10 on macros can return parameters to the caller object. At the caller's side, returned values can be collected using the `returned_parameters` keyword followed by a variable list. The returned values will be stored in these variables in the order they are returned in the called macro. The number and the type of the variables specified in the caller and those returned in the macro must not match. If there are more variables specified in the caller, they will be set to 0 integer. Type compatibility is not checked: the type of the variables specified in the caller will be set to the type of the returned values. If one of the variables in the caller is a dynamic array, all next values will be stored in it. In the macro object the `end` and the `exit` commands define the values that have to be return to the caller object. See the example below.

Advanced parameters all

From ARCHICAD 10 on after `parameters all` keyword you can specify extra parameters to pass it to the macro. They will override the values coming from the caller or parameters of the called macro left to be default. The macro can return parameters in this case also.

Faster macro call

Speed of parameter value transferring between the caller object and the macro was improved in ARCHICAD 10. Find out tips about utilization of macro call's speed enhancements in the section called "Speed Issues".

Macro call example

Script in the caller object.

```
call "myMacro" parameters all extraParam = 1
call "myMacro" parameters returned_parameters realWidth
call "myMacro" parameters all extraParam = 1 returned_parameters realWidth
call "myMacro" parameters all returned_parameters realWidth
```

Script in the macro.

```
realWidth = 2
end realWidth
```

Background Conversion Issues

Starting from ARCHICAD 19, all calculations necessary for opening 3D related views or viewpoints will be run as background processes.

Supported viewpoints:

- 3D Window
- Section
- Elevation
- Interior elevation (except when "Add bounded area" or "Detect and Fit to Zones" are enabled)
- 3D Document

If the background process is successful, the requested view takes only a few seconds to open. **However, there may be some non thread-safe library parts or objects placed in the planfile, which can disable background calculations:**

- Zones
- Objects including text engine operations (except set style and define style commands)
- Objects using the following requests: "CUSTOM_AUTO_LABEL", "ZONE_COLUS_AREA", "MATCHING_PROPERTIES", "ASSOCEL_PROPERTIES", "STYLE_INFO", "TEXTBLOCK_INFO", "FONTNAMES_LIST"
- Objects using variable named macros, requests, or non-thread safe macros. Project2 command or symbol fill definition are counted as non-thread safe macro calls.

The relationship between GDL add-ons and background processing depends on the add-on itself.

Deterministic add-ons (not affecting background processing):

- Polygon Operations
- Property Add-on
- If used in read-only mode, and with files loaded in the active library: Text or Data I/O Add-ons, XML Add-on

Non-deterministic add-ons (disabling background processing):

- DateTime Add-on
- FileManager Add-on
- If not used in read-only mode, or not with files loaded in the active library: Text or Data I/O Add-ons, XML Add-on

The object scripts are examined statically, so the background conversion is disabled even if the obstacle function itself is not executed with the current settings of the library part.

To check the loaded library parts' compatibility with background processing, use the "Check if Library Parts are Thread Safe" command of the Library Developer menu.

Speed Issues

Try to avoid using the `project2` command as it slows down plan regeneration.

Reduce the number of surfaces in your model to the minimum in order to make 3D regeneration faster. Use `RESOL`, `TOLER` and `RADIUS` commands to control segmentation of curved surfaces.

Note that closed bodies regenerate faster in 3D than open ones (e.g, a cylinder is faster than an open tube).

When scripting the master script consider that the master script is run before each script type, so don't put script-type specific calculations here. This is the place for common calculations needed by multiple scripts.

When scripting doors and windows avoid making unnecessary cuts (`wallhole` and `wallniche`).

Use integer values and operations whenever reasonable, these are much faster than floating point operations.

Try to minimize the usage of string operations.

In case of calling macros use the same parameter order after the `call` command as it is in the parameter list of the macro. `call "myMacro" parameters all` is faster when the parameter orders of the macro and the caller object are similar. Try to avoid transferring string type parameters in macro calls. Use numeric types where possible.

Windows-Macintosh compatibility

Though GDL objects and libraries are considered by GRAPHISOFT as platform independent, the following difficulties occur when objects are manually moved from Windows to a Macintosh:

- Windows fonts will be replaced by the default Macintosh font in objects and list templates and vice-versa.

- Text type listing files (listset.txt, listkey.txt, list templates, etc.) could lose line breaks, therefore listing won't work (non-utf-8 coded texts, usually)

Changing platform with binary libraries

To avoid the above problems, save a .pla archive file of your library on the first platform, then extract it on the second. This way the non-utf-8 files will be converted correctly as well.

Images and HDPI support in GDL

Starting from ARCHICAD 21 real HDPI support is available for OS X devices. To provide this feature, scalable vector graphics (.svg) source images are used to create multi-representation .tiff images, containing versions of the same graphic at different resolutions. ARCHICAD decides at runtime which image resolution is the best for the current display device from the available set of 100%, 150%, and 200%. On Windows platform 100% is the default resolution. However, images created from .svg files have a slightly different look on Windows platform as well.

This option is only available via the LP_XMLConverter tool. The .svg source image files are automatically converted to .tiff images during library conversion. A .gsm object cannot handle .svg images, so make sure the image name reference strings in scripts contain the .tiff extension (or omit the extension).

Always test vector images in all resolutions (the .tiff images can be checked by any image editor, resolution-by-resolution) to avoid blurry images after scaling (use lines aligned to full pixels in the source .svg as much as possible. Same recommendation as for .png images.)

The syntax requirements of any .svg **built-in image** (where the image is compiled into the binary library part itself) in GDLPicture, Picture, InfoPicture .xml sections are the following:

- MIME attribute is "image/svg". In case the MIME-type and the source image extension is different, the conversion ends with a warning (MIME is "image/svg", but the image file's extension is not svg)
- SectionFlags attribute is "1". This flag triggers the .tiff conversion. If the image is an .svg and the flag is different, a warning is displayed during conversion (SectionFlags should be "1" in case of an svg image).

The rest of the image reference in GDLPicture, Picture, InfoPicture .xml sections have not changed. Make sure to get the extension of the source image right in the path.

Non-built-in images, which are directly referred by their name in the object scripts are handled by the LP_XMLConverter tool as well:

- The .svg image should be part of the library source, but not in the _images folder.
- The conversion creates the .tiff counterparts of the .svg source images to the exact same location. The .svg source images are also copied to the binary library to a separate folder (_svg_source name extension), to support the source.xml to .gsm to reverse.xml comparison workflow. This extra folder can be avoided by the `-excludesvg` option of the LP_XMLConverter tool.

Any kind of .svg to .tiff conversion failure results in a warning or an error during library builds.

For tutorials and examples on the subject and the LP_XMLConverter tool, check out the [GDL Center Tips and Tricks](https://gdl.graphisoft.com/tips-and-tricks/how-to-use-the-lp_xmlconverter-tool) [https://gdl.graphisoft.com/tips-and-tricks/how-to-use-the-lp_xmlconverter-tool] guides.

DOORS AND WINDOWS

This section discusses the various special options related to the creation of Door/Window library elements.

General Guidelines

Once a door/window is inserted into a wall, the default position of these library parts' coordinate system is rotated so that the x-y plane is vertical and the z axis points horizontally into the wall. The origin is placed on the bottom center of the wall opening, on the exterior side of the wall. This way, doors/windows can be easily modeled by elements in the x-y plane. See the illustrations below.

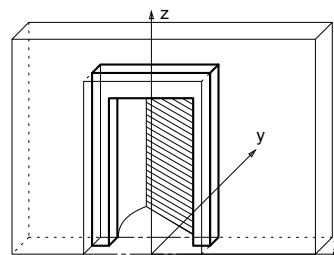
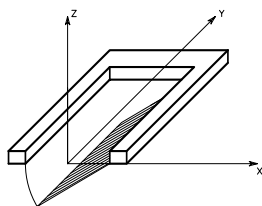

Because of the special behavior of these library parts, the 2D symbol is generated from a special built-in projection otherwise not accessible by users (an upside-down side view from a 90 degree direction). The symbol and the 3D shape are fitted to the Door/Window origin by the lower (y) center (x) of the bounding box, but no adjustment is made along the z axis to enable users to design doors/windows extending beyond the wall in either z direction.

Considering these rules, here are some hints that will help you construct doors/windows that will work properly:

- When constructing the door/window in the floor plan window, visualize it as if you are looking at it from the inside of the wall it will be inserted into.
- Think of the project zero level as the external surface of the wall.
- Elements that should be inside the wall, like the window frame, should be above the zero level.
- Door panels opening to the outside should be below the zero level.

Positioning

A door is correctly defined if its insertion works as follows: clicking to the right of the insertion point means that the door leaf will open to the same side on the right. A window is correctly defined if, upon insertion, the side that is clicked corresponds to the outer side.

An opening position can take one of 8 forms. These are represented by three global variables in GDL:

- mirroring to the Y-Z plane in 3D or to the Y axis in 2D (SYMB_MIRRORED)
- mirroring by the longitudinal axis of the wall (rotation by 180 degrees: SYMB_ROTANGLE)
- flipping (WIDO_REVEAL_SIDE)

Usually each part of the window should react in a different way to these conditions. The specification must be clear on deciding how the parts of the object should, or should not act. E.g. a door leaf moves with these transformations, but the cavity closure does not. To keep the library part consistent, several transformations should be used for these combinations. When changing the reveal side (flipping), the library part is mirrored and dragged back by the value of the nominal frame thickness.

Illustration of the 8 states with a simplified door - the little circle flags the origin.

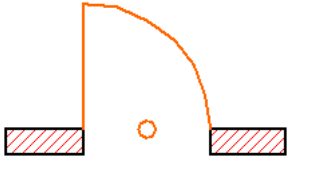
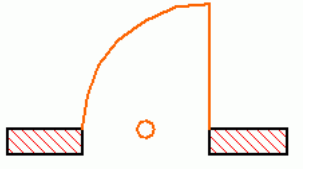
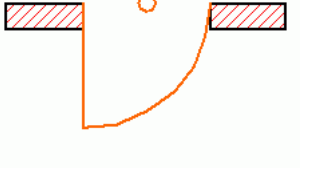
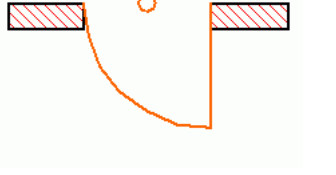
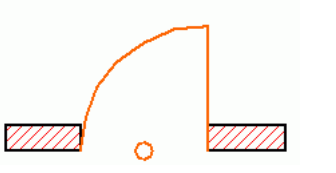
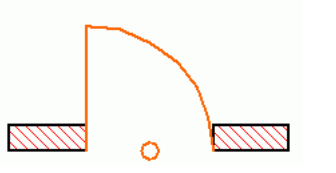
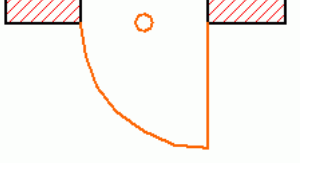
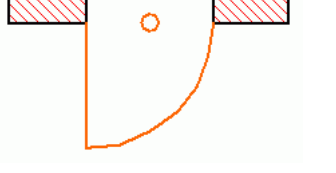
Global variables 1.	Example drawing 1.	Global variables 2.	Example drawing 2.
<pre>WIDO_REVEAL_SIDE = 0 SYMB_MIRRORED = 0 SYMB_ROTANGLE = 0</pre>		<pre>WIDO_REVEAL_SIDE = 0 SYMB_MIRRORED = 1 SYMB_ROTANGLE = 0</pre>	
<pre>WIDO_REVEAL_SIDE = 1 SYMB_MIRRORED = 0 SYMB_ROTANGLE = 180</pre>		<pre>WIDO_REVEAL_SIDE = 1 SYMB_MIRRORED = 1 SYMB_ROTANGLE = 180</pre>	
<pre>WIDO_REVEAL_SIDE = 1 SYMB_MIRRORED = 0 SYMB_ROTANGLE = 0</pre>		<pre>WIDO_REVEAL_SIDE = 1 SYMB_MIRRORED = 1 SYMB_ROTANGLE = 0</pre>	
<pre>WIDO_REVEAL_SIDE = 0 SYMB_MIRRORED = 0 SYMB_ROTANGLE = 180</pre>		<pre>WIDO_REVEAL_SIDE = 0 SYMB_MIRRORED = 1 SYMB_ROTANGLE = 180</pre>	

Sample code undoing the automatic transformations done by ARCHICAD:

```
! 2D script
bRotated = round_int (SYMB_ROTANGLE) = 180
if bRotated then
  rot2 180
endif
if SYMB_MIRRORED then
  mul2 -1, 1
endif
if WIDO_REVEAL_SIDE exor bRotated then
  add2 0, WALL_THICKNESS
endif

! 3D script
bRotated = round_int (SYMB_ROTANGLE) = 180
if bRotated then
  roty 180
endif
if SYMB_MIRRORED then
  mulx -1
endif
if WIDO_REVEAL_SIDE exor bRotated then
  addz -WALL_THICKNESS
endif
```

Note that though flipping and mirroring is possible for all doors and windows, it is incorrect in manufacturer libraries where a library part models a real window - which, of course, cannot be turned inside out. In this case the script should undo the mirroring done by ARCHICAD.

Creation of Door/Window Library Parts

When creating Door/Window type library parts, several possibilities exist, presenting different problems:

- Creation of rectangular doors/windows in straight walls
- 3D related challenges
 - Creation of non-rectangular doors/windows in straight walls
 - Creation of rectangular doors/windows in curved walls
 - Creation of non-rectangular doors/windows in curved walls
- 2D related challenges
 - Cutting custom wall opening

- WALLHOLE2
- Extending the wall polygon
- WALLBLOCK2
- WALLLINE2
- WALLARC2

Rectangular Doors/Windows in Straight Walls

This is the easiest and most straightforward way of creating doors and windows. The use of simple GDL commands such as PRISM_ or RECT is recommended.

If you want to match the surface materials of door/window elements to those of the wall, the bottom surface of the elements should match the outside, and the top surface the inside of the wall. You can achieve this from your scripts using the WALL_MAT_A, WALL_MAT_B and WALL_MAT_EDGE global variables representing the surface materials of the wall into which the door/window is placed. In the 2D script, the WALL_SECT_PEN, WALL_FILL_PEN and WALL_FILL global variables can be useful, as these give you the pen numbers of the wall contour and fill plus the index number of the fill of the wall on the floor plan into which the door/window is placed. With composite walls, you have to use the corresponding global variables.

See Miscellaneous for details.

The object libraries come with a large set of door/window macros. These GDL scripts contain common building elements which are used by many doors/windows in the library. There are macros for generating commonly-used frames, panels and many other types of door/window parts. Open some door/window library parts to see what kind of macros they call and what type of parts those macros generate.

Example:

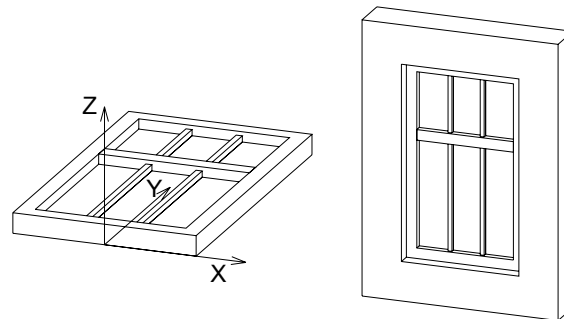

```
a=0.9: b=1.5: c=0.1: d=0.08
e=0.08: f=0.9: g=0.03: h=3
PRISM_ 10, c,
      -a/2, 0, 15, a/2, 0, 15,
      a/2, b, 15, -a/2, b, 15,
      -a/2, 0, -1,
      -a/2+d, d, 15, a/2-d, d, 15,
      a/2-d, b-d, 15, -a/2+d, b-d, 15,
      -a/2+d, d, -1
ADD -a/2+d, f, 0
BRICK a-2*d, e, c
ADD -g/2, -f+d, c/2
GOSUB 1
ADDZ -g
GOSUB 1
DEL 2
MATERIAL "Glass - Blue"
ADD 0, -f+d, c/2
RECT a-2*d, f-d
ADDY f-d+e
RECT a-2*d, b-f-e-d
END

1:
  FOR i=1 TO h-1
    ADDX (a-2*d)/3
    BLOCK g, f-d, g
    ADDY f+e-d
    BLOCK g, b-f-d-e, g
    DEL 1
  NEXT i
  DEL h-1
  RETURN
```

3D Related Challenges

Non-Rectangular Doors/Windows in Straight Walls

When working with doors/windows, it is important to know that placing a door/window always cuts a rectangular hole into the wall. The size of this hole is determined by the A and B parameters of the door/window library part. However, when the door/window is not rectangular in elevation, it does not entirely fill the cut rectangular hole. The solution to this is to use the WALLHOLE or WALLNICHE command to define a polygon shape to be cut into the wall where the door/window is placed. There are two solutions for this:

- The 3D script has to contain parts that generate those parts of the wall that fill the hole between the door/window body and the edges of the rectangular wall cut. In this case, special attention must be paid to the visibility of the edges of these fillings.

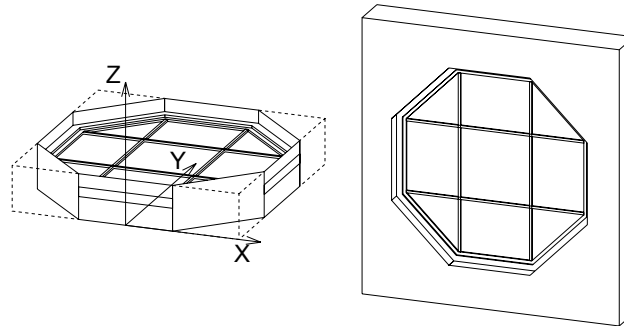

- With the WALLHOLE or WALLNICHE command, you can define a polygon shape to be cut into the wall where the door/window is placed.

WALLHOLE

```
WALLHOLE n, status,
         x1, y1, mask1,
         ...
         xn, yn, maskn
         [, x, y, z]
```

n: the number of polygon nodes.

status:

- 1: use the attributes of the body for the generated polygons and edges,
- 2: generated cut polygons will be treated as normal polygons.

xi, yi: cross-section polygon coordinates.

maski: similar to the CUTPOLYA command:

$\text{maski} = j_1 + 2*j_2 + 4*j_3 + 64*j_7$, where each j can be 0 or 1.

x, y, z: optional direction vector (default is door/window Z axis).

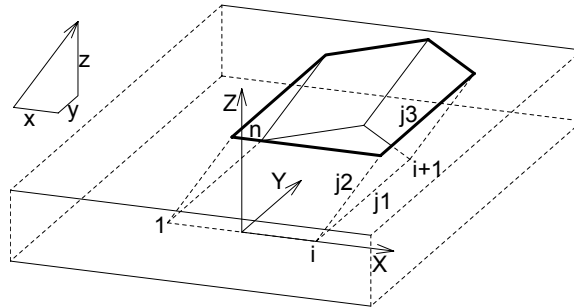

This command can be used in doors'/windows' 3D script to cut custom hole(s) in the wall they are placed into. During the 3D generation of the current wall, the 3D script of all its doors/windows is interpreted without model generation to collect the WALLHOLE commands. If they exist, the current wall will be cut using an infinite tube with the polygonal cross-section and direction defined in the script. There can be any number of WALLHOLES for any door/window, so it is possible to cut more holes for the same door/window, even intersecting ones. If at least one WALLHOLE command is interpreted in a door/window 3D script, no rectangular opening will be generated for that door/window.

Note: The 3D reveal will not be generated automatically for custom holes, you have to generate it from the script. The hole customized this way will only be visible in 3D, because WALLHOLE commands do not have any effect in 2D. A 2D representation can be scripted if needed (used with framing in plan off).

The use of convex polygonal cross-sections is recommended; using concave polygons may result in strange shadings/renderings or cut errors. Convex polygons can be combined to obtain concave ones. Mirroring transformations affect the cutting direction in an unexpected way - to get a more straightforward result, use the WALLNICHE command.

Example 1:

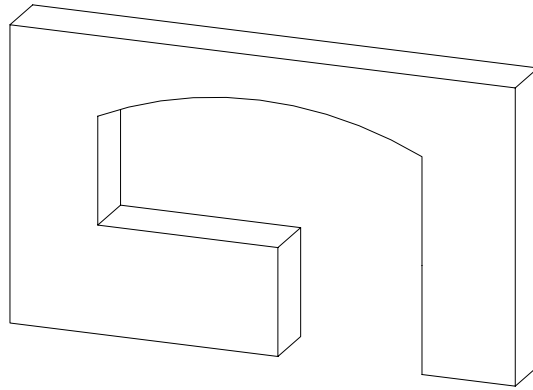

```

RESOL 72
l1 = 2.7: l2=1.2
h1=2.1: h2=0.3: h3=0.9
r = ((l1/2)^2+h2^2)/(2*h2)
a = ATN((l1/2)/(r-h2))
WALLHOLE 5, 1,
    -l1/2, h3, 15,
    l1/2, h3, 15,
    l1/2, h1-h2, 13,
    0, h1-r, 915,
    0, 2*a, 4015
WALLHOLE 4, 1,
    l1/2-l2, 0, 15,
    l1/2, 0, 15,
    l1/2, h3, 15,
    l1/2-l2, h3, 15

```

Example 2:

```

WALLHOLE 5, 1,
    -0.45, 0, 15,
    0.45, 0, 15,
    0.45, 1.5, 15,
    0, 1.95, 15,
    -0.45, 1.5, 15
PRISM_ 12, 0.1,
    -0.45, 0, 15,
    0.45, 0, 15,
    0.45, 1.5, 15,
    0, 1.95, 15,
    -0.45, 1.5, 15,
    -0.45, 0, -1,
    -0.35, 0.1, 15,
    0.35, 0.1, 15,
    0.35, 1.45, 15,
    0, 1.80, 15,
    -0.35, 1.44, 15,
    -0.35, 0.1, -1

```

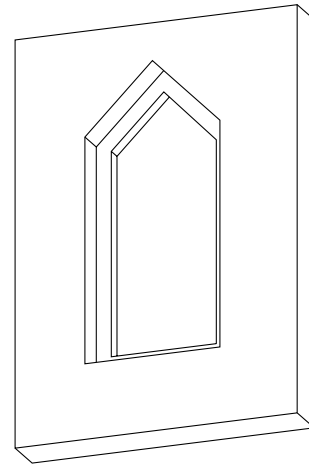

WALLNICHE

```

WALLNICHE n, method, status,
    rx, ry, rz, d,
    x1, y1, mask1, [mat1,]
    ...
    xn, yn, maskn[, matn]

```

Similar to the CUTFORM command.

method: Controls the form of the cutting body:

- 1: prism shaped,
- 2: pyramidal,
- 3: wedge-shaped cutting body. The direction of the wedge's top edge is parallel to the Y axis and its position is in rx, ry, rz (ry is ignored).

status: Controls the extent of the cutting body and the treatment of the generated cut polygons and new edges.

status = $j_1 + 2*j_2 + 8*j_4 + 16*j_5 + 32*j_6 + 64*j_7 + 128*j_8 + 256*j_9$, where each j can be 0 or 1.

- j₁**: use the attributes of the body for the generated polygons and edges,
j₂: generated cut polygons will be treated as normal polygons,
j₄: define the limit of the cut (with j₄),
j₅: define the limit of the cut (with j₅),
j₆: generate a boolean intersection with the cutting body rather than a boolean difference. (can only be used with the CUTFORM command),
j₇: edges generated by the bottom of the cutting body will be invisible,
j₈: edges generated by the top of the cutting body will be invisible.
j₉: cutting shape has custom side materials (mati).
j₄ = 0 and j₅ = 0: finite cut,
j₄ = 0 and j₅ = 1: semi-infinite cut,
j₄ = 1 and j₅ = 1: infinite cut,
rx, ry, rz: defines the direction of cutting if the cutting form is prism-shaped, or the top of the pyramid if the method of cutting is pyramidal.
d: defines the distance along rx,ry,rz to the end of the cut. If the cut is infinite, this parameter has no effect. If the cut is finite, then the start of the cutting body will be at the local coordinate system and the body will end at a distance of d along the direction defined by rx,ry,rz.
 If the cut is semi-infinite, then the start of the cutting body will be at a distance of d along the direction defined by rx,ry,rz and the direction of the semi-infinite cut will be in the opposite direction defined by rx,ry,rz.
mati: side material of the cutting shape (when status j₉ = 1)
mask: Defines the visibility of the edges of the cutting body.
j₁: the polygon will create a visible edge upon entry into the body being cut,
j₂: the lengthwise edge of the cutting form will be visible,
j₃: the polygon will create a visible edge upon exiting the body being cut,
j₄: the bottom edge of the cutting form will be visible,
j₅: the top edge of the cutting form will be visible,
j₇: controls the viewpoint dependent visibility of the lengthwise edge.

Rectangular Doors/Windows in Curved Walls

When placing doors/windows into curved walls, the sides of the hole cut into the wall can vary according to the picture below.

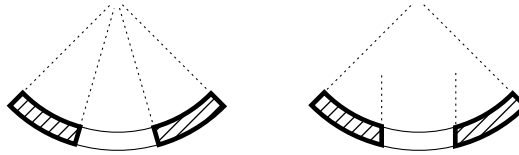

The hole in the wall on the left is created when the program automatically cuts the hole for the door/window. In this case the sides will be of radial direction. On the right, the hole is cut using the WALLHOLE command in the 3D Script of the door/window object. The object itself needs to be written by taking these factors into consideration.

Another thing to consider is whether the door/window placed into the curved wall is a straight or a curved one.



In the case of a straight door/window, as on the left above, the thickness and width of the object and the thickness of the wall are closely related, since above a certain dimension the object would fall outside of the wall. When using true curved doors/windows, this problem doesn't occur.

Example: Window with a frame following the curve of the wall

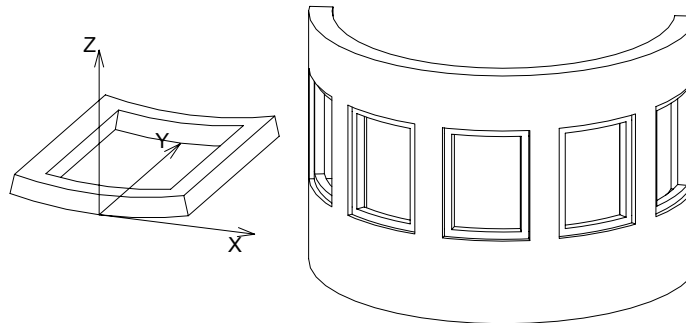

```

RESOL 72
ROTX -90 : MULY -1
C= 0.12 : Z=360*A/(2*WIDO_ORIG_DIST*PI)
Y= 360*C/(2*WIDO_ORIG_DIST*PI) : A1= 270+Z/2 : A2=270-Z/2
GOSUB "curved_horizontal_frame"
ADDZ B
MULZ -1
GOSUB "curved_horizontal_frame"
DEL 2
ADDZ C
GOSUB "vertical_frame"
MULX -1
GOSUB "vertical_frame"
END
"curved_horizontal_frame":
  PRISM_ 9, C,
    cos(A2)*R_ , SIN(A2)*R_+R_ , 11,
    cos(A2+Y)*R_ , sin(A2+Y)*R_+R_ , 13,
    0, R_ , 900,
    0, Z-2*Y, 4009,
    cos(A1)*R_ , sin(A1)*R_+R_ , 11,
    cos(A1)*(R_-0.1) , sin(A1)*(R_-0.1)+R_ , 11,
    cos(A1-Y)*(R_-0.1) , sin(A1-Y)*(R_-0.1)+R_ , 13,
    0, -(Z-2*Y) , 4009,
    cos(A2)*(R_-0.1) , sin(A2)*(R_-0.1)+R_ , 11
  RETURN
"vertical_frame":
  PRISM_ 4, B-2*C,
    cos(A2)*R_ , sin(A2)*R_+R_ , 10,
    cos(A2+Y)*R_ , sin(A2+Y)*R_+R_ , 15,
    cos(A2+Y)*(R_-0.1) , sin(A2+Y)*(R_-0.1)+R_ , 10,
    cos(A2)*(R_-0.1) , sin(A2)*(R_-0.1)+R_ , 10
  RETURN

```

Non-Rectangular Doors/Windows in Curved Walls

The general guidelines given for rectangular doors/windows in curved walls applies here, too.

Example:

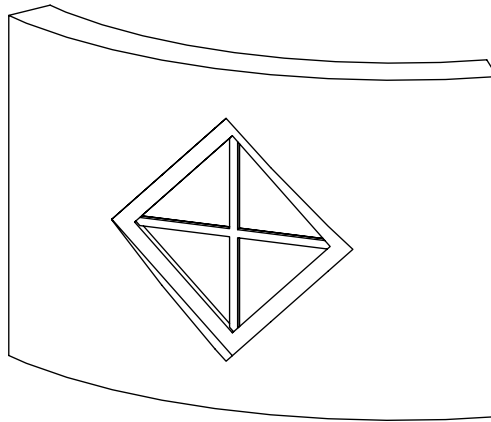

```
wFrame=0.1: wDivider=0.025
Z=A/2-SQR(2)*wFrame: Y=A/2-SQR(2)*wFrame-wDivider
ADDY A/2
WALLHOLE 4, 1,
    0, -A/2, 15,
    A/2, 0, 15,
    0, A/2, 15,
    -A/2, 0, 15
PRISM_ 10, 0.1,
    0, -A/2, 15,
    A/2, 0, 15,
    0, A/2, 15,
    -A/2, 0, 15,
    0, -A/2, -1,
    0, -Z, 15,
    Z, 0, 15,
    0, Z, 15,
    -Z, 0, 15,
    0, -Z, -1
ADDZ 0.02
GOSUB "cross_divider"
ADDZ 0.03
GOSUB "cross_divider"
ADDY -Z
SET MATERIAL "Glass - Blue"
ROTZ 45
RECT SQR(2)*Z, SQR(2)*Z
END
```

```

"cross divider":
  PRISM_ 16, 0.03,
    0, -Z, 15,
    wDivider, -Y, 15,
    wDivider, -wDivider, 15,
    Y, -wDivider, 15,
    Z, 0, 15,
    Z, wDivider, 15,
    wDivider, wDivider, 15,
    wDivider, Y, 15,
    0, Z, 15,
    -wDivider, Y, 15,
    -wDivider, wDivider, 15,
    -Y, wDivider, 15,
    -Z, 0, 15,
    -Y, -wDivider, 15,
    -wDivider, -wDivider, 15,
    -wDivider, -Y, 15

```

RETURN

2D Related Challenges

Cutting custom wall opening

Placing a door/window cuts a rectangular hole into the wall by default. The size of this hole in 2D is determined by the A parameters of the door/window library part. Implementing custom reveals or cavity closures requires cutting custom shaped holes in the wall or extending it a bit in the floor plan view.

A correct solution for this issue can be achieved by using the WALLHOLE2, WALLBLOCK2, WALLLINE2 and WALLARC2 commands.

WALLHOLE2

```

WALLHOLE2 n, fill_control, fill_pen, fill_background_pen,
  fillOrigoX, fillOrigoY, fillAngle,
  x1, y1, s1,
  ...
  xn, yn, sn

```

Wall opening definition for the plan view coupled with a cover polygon. Only the cut part of the wall is affected, view wall polygons stay intact. The cover polygon has no contour.

This command can be used in the 2D script of door/window objects only.

The parameterization of the command is mainly the same as the one of the POLY2_B{2} command.

fill_control:

$fill_control = 2*j_2 + 8*j_4 + 16*j_5 + 32*j_6 + 64*j_7$, where each j can be 0 or 1.

j_2 : draw cover fill on the polygon,

j_4 : local fill orientation,

j_5 : local fill should align with the wall direction (fill origin is at the wall origin and directions are matching),

j_6 : fill is cut fill (default is drafting fill),

j_7 : fill is cover fill (only if $j_6 = 0$, default is drafting fill).

WALLHOLE2{2}

```
WALLHOLE2{2} n, frame_fill, fillcategory, distortion_flags,
    fill_pen, fill_background_pen,
    fillOrigoX, fillOrigoY,
    mxx, mxy, myx, myy,
    innerRadius,
    x1, y1, s1,
    ...
    xn, yn, sn
```

Advanced version of WALLHOLE2, where fill distortion can be controlled in an enhanced way.

It is equivalent to the POLY2_B{5} command in the geometric definition.

distortion_flags:

$distortion_flags = j_1 + 2*j_2 + 4*j_3 + 8*j_4 + 16*j_5 + 32*j_6 + 64*j_7 + 128*j_8$, where each j can be 0 or 1.

The valid value for $distortion_flags$ is between 0 and 255. Don't use value out of this range.

j_1 - j_7 : similar to the POLY2_B{5} command,

j_8 : local fill should align with the wall direction (fill origin is at the wall origin and directions are matching), meaningful only when j_4 is set. Distortion matrix (m_{ij} parameters) are omitted.

Extending the wall polygon

WALLBLOCK2

```
WALLBLOCK2 n, fill_control, fill_pen, fill_background_pen,
            fillOrigoX, fillOrigoY, fillAngle,
            x1, y1, s1,
            ...
            xn, yn, sn
```

WALLBLOCK2{2}

```
WALLBLOCK2{2} n, frame_fill, fillcategory, distortion_flags,
            fill_pen, fill_background_pen,
            fillOrigoX, fillOrigoY,
            mxx, mxy, myx, myy,
            innerRadius,
            x1, y1, s1,
            ...
            xn, yn, sn
```

Wall polygon (extension) definition for the plan view. Both the cut and view wall polygons are cut by the defined polygon. Wall openings defined via WALLHOLE2 in another window/door object cut the polygon generated by this command, while wallholes coming from the same object don't.

This command can be used in the 2D script of door/window objects only.

The parameterization of the command is exactly the same as the ones of WALLHOLE2.

WALLLINE2

```
WALLLINE2 x1, y1, x2, y2
```

Wall line (extension) definition between two points for the plan view. Wall openings defined via WALLHOLE2 in another window/door object cut the line generated by this command, while wallholes coming from the same object don't.

This command can be used in the 2D script of door/window objects only.

The parameterization of the command is exactly the same as the one of the LINE2 command.

WALLARC2

```
WALLARC2 x, y, r, alpha, beta
```

An arc with its centerpoint at (x, y) from the angle alpha to beta, with a radius of r, which is drawn by the containing wall. Wall openings defined via WALLHOLE2 in another window/door object cut the arc generated by this command, while wallholes coming from the same object don't.

This command can be used in the 2D script of door/window objects only.

The parameterization of the command is exactly the same as the one of the ARC2 command.

GDL CREATED FROM THE FLOOR PLAN

Saving the floor plan as a GDL script or library part will result GDL elements. You can use these GDL scripts as templates for your custom library parts.

KEYWORDS

Common Keywords

```
FILE_DEPENDENCE
MOD
AND
OR
EXOR
FOR
TO
STEP
NEXT
DO (at DO - WHILE, at WHILE - ENDWHILE)
WHILE (at DO - WHILE, at WHILE - ENDWHILE)
ENDWHILE
REPEAT
UNTIL
IF (at IF - GOTO, at IF - THEN - ELSE - ENDIF)
THEN (at IF - GOTO, at IF - THEN - ELSE - ENDIF)
GOTO (at IF - GOTO, at GOTO)
GOSUB (at IF - GOTO, at GOSUB)
ELSE
ENDIF
RETURN
```

```
END
EXIT
BREAKPOINT

FILLTYPES_MASK (at DEFINE FILL, at DEFINE FILLA, at DEFINE SYMBOL_FILL, at DEFINE
SOLID_FILL, at DEFINE EMPTY_FILL, at DEFINE LINEAR_GRADIENT_FILL, at DEFINE
RADIAL_GRADIENT_FILL, at DEFINE TRANSLUCENT_FILL, at DEFINE IMAGE_FILL, at VALUES)
PROFILETYPES_MASK
DICT
DIM
PUT
GET
USE
NSP
CALL
RETURNED_PARAMETERS
DEFAULT
PRINT

HASKEY
REMOVEKEY
VARDIM1
VARDIM2
PARVALUE_DESCRIPTION
ABS
CEIL
INT
FRA
ROUND_INT
SGN
SQR
ACS
ASN
```

ATN
COS
SIN
TAN
PI
EXP
LGT
LOG
NOT
MIN
MAX
RND
BITTEST
BITSET
REQ
REQUEST
IND
APPLICATION_QUERY
LIBRARYGLOBAL
STR
STR{2}
SPLIT
STW
STRLEN
STRSTR
STRSUB
STRTOUPPER
STRTOLOWER
OPEN
INPUT
VARTYPE
OUTPUT
CLOSE

INITADDDONSCOPE
PREPAREFUNCTION
CALLFUNCTION
CLOSEADDDONSCOPE

Reserved Keywords

The keywords listed below are reserved; they exist for compatibility reasons or are not publicized.

BAS
BOX
CONT
FILTER
GDLBIN
HIP_ROOFS
LIN
LINE
MIGRATIONWARNING
NOD
NODE
ORIGO
PARS
PAUSE
PLOTMAKER
PLOTTER
RECT_
REF_
SFLINE
TET
TETRA
TRI
WALL_
VOCA_
UI_OK
UI_CANCEL

3D Use Only

ADDX

ADDY
ADDZ
ADD
MULX
MULY
MULZ
MUL
ROTX
ROTY
ROTZ
ROT
XFORM

BLOCK
BRICK
CYLIND
SPHERE
ELLIPS
CONE
PRISM
PRISM_
CPRISM_
CPRISM_{2}
CPRISM_{3}
CPRISM_{4}
BPRISM_
FPRISM_
HPRISM_
SPRISM_
SPRISM_{2}
SPRISM_{3}
SPRISM_{4}
SLAB

SLAB_
CSLAB_
CWALL_
BWALL_
XWALL_
XWALL_{ 2 }
XWALL_{ 3 }
BEAM
CROOF_
CROOF_{ 2 }
CROOF_{ 3 }
CROOF_{ 4 }
MESH
ARMC
ARME
ELBOW
EXTRUDE
PYRAMID
REVOLVE
REVOLVE{ 2 }
REVOLVE{ 3 }
REVOLVE{ 4 }
REVOLVE{ 5 }
RULED
RULED{ 2 }
RULEDSEGMENTED
RULEDSEGMENTED{ 2 }
SWEEP
TUBE
TUBE{ 2 }
TUBEA
COONS
COONS{ 2 }

MASS
MASS { 2 }
POLYROOF
POLYROOF { 2 }
POLYROOF { 3 }
POLYROOF { 4 }
EXTRUDESHELL
EXTRUDESHELL { 2 }
EXTRUDESHELL { 3 }
REVOLVEDSHELL
REVOLVEDSHELL { 2 }
REVOLVEDSHELL { 3 }
REVOLVEDSHELLANGULAR
REVOLVEDSHELLANGULAR { 2 }
REVOLVEDSHELLANGULAR { 3 }
RULEDSHELL
RULEDSHELL { 2 }
RULEDSHELL { 3 }
TEXT
BODY
BASE
NURBSCURVE2D
NURBSCURVE3D
NURBSSURFACE
NURBSVERT
NURBSEDGE
NURBSTRIM
NURBSTRIMSINGULAR
NURBSFACE
NURBSFACE { 2 }
NURBSLUMP
NURBSBODY
POINTCLOUD

CUTPLANE
CUTEND (at CUTPLANE, at CUTPLANE{2}, at CUTPLANE{3}, at CUTPOLY, at CUTPOLYA, at CUTSHAPE)
CUTPLANE{2}
CUTPLANE{3}
CUTPOLY
CUTPOLYA
CUTSHAPE
CUTFORM
CUTFORM{2}
GROUP
ENDGROUP
ADDGROUP
ADDGROUP{2}
ADDGROUP{3}
SUBGROUP
SUBGROUP{2}
SUBGROUP{3}
ISECTGROUP
ISECTGROUP{2}
ISECTGROUP{3}
ISECTLINES
PLACEGROUP
KILLGROUP
SWEEPGROUP
SWEEPGROUP{2}
SWEEPGROUP{3}
SWEEPGROUP{4}
SWEEPGROUP{5}
CREATEGROUPWITHMATERIAL
BINARY
WALLNICHE

HOTSPOT

HOTLINE
HOTARC
LIN_
RECT
POLY
POLY_
PLANE
PLANE_
CIRCLE
ARC
LIGHT
PICTURE
RICHTEXT
VERT (at VERT, at VERT{2})
TEVE
VECT
EDGE
PGON
PGON{2}
PGON{3}
PIPG
COOR
COOR{2}
COOR{3}
MODEL
WIRE
SURFACE
SOLID
MATERIAL (at [SET] MATERIAL, at IND)
BUILDING_MATERIAL (at [SET] BUILDING_MATERIAL, at IND)
SECT_FILL
SECT_ATTRS
SECT_ATTRS{2}

SHADOW
ON
OFF
AUTO
DEFINE MATERIAL (at DEFINE MATERIAL, at DEFINE MATERIAL BASED_ON)
BASED_ON
DEFINE TEXTURE
TEXTURE
WALLHOLE

2D Use Only

ADD2
MUL2
ROT2

LINE2
RECT2
POLY2
POLY2_
POLY2_A
POLY2_B
POLY2_B{2}
POLY2_B{3}
POLY2_B{4}
POLY2_B{5}
POLY2_B{6}
ARC2
CIRCLE2
SPLINE2
SPLINE2A
TEXT2
RICHTEXT2
FRAGMENT2

PROJECT2
PROJECT2 {2}
PROJECT2 {3}
PROJECT2 {4}
DRAWING2
DRAWING3
DRAWING3 {2}
DRAWING3 {3}
WALLHOLE2
WALLHOLE2 {2}
WALLBLOCK2
WALLBLOCK2 {2}
WALLLINE2
WALLARC2

HOTSPOT2
HOTLINE2
HOTARC2
PICTURE2
PICTURE2 {2}
LINE_PROPERTY
DRAWINDEX
FILL (at [SET] FILL, at IND)
LINE_TYPE (at [SET] LINE_TYPE, at IND)
DEFINE FILL
DEFINE FILLA
DEFINE SYMBOL_FILL
DEFINE SOLID_FILL
DEFINE EMPTY_FILL
DEFINE LINEAR_GRADIENT_FILL
DEFINE RADIAL_GRADIENT_FILL
DEFINE TRANSLUCENT_FILL
DEFINE IMAGE_FILL

```
DEFINE LINE_TYPE  
DEFINE SYMBOL_LINE
```

2D and 3D Use

```
DEL (at DEL, at DEL TOP)  
TOP  
NTR  
ADDITIONAL_DATA (at LIGHT, at DEFINE MATERIAL BASED_ON)  
LET  
RADIUS  
RESOL  
TOLER  
PEN  
SET (at [SET] STYLE, at [SET] MATERIAL, at [SET] BUILDING_MATERIAL, at [SET] FILL, at [SET]  
LINE_TYPE)  
STYLE (at [SET] STYLE, at IND)  
DEFINE STYLE  
DEFINE STYLE{2}  
PARAGRAPH  
ENDPARAGRAPH  
TEXTBLOCK  
TEXTBLOCK_  
PROFILE_ATTR
```

Non-Geometric Scripts

Properties Script

```
DATABASE_SET  
DESCRIPTOR  
REF DESCRIPTOR  
COMPONENT  
REF COMPONENT
```

BINARYPROP
SURFACE3D
VOLUME3D
POSITION
WALLS
COLUMNS
BEAMS
DOORS
WINDOWS
OBJECTS
CEILS
PITCHED_ROOFS
LIGHTS
HATCHES
ROOMS
MESHES
DRAWING

Parameter Script

VALUES
CUSTOM (at VALUES, at UI_INFIELD{4})
RANGE
VALUES{2}
PARAMETERS (at PARAMETERS, at CALL)
LOCK
ALL (at LOCK, at HIDEPARAMETER, at CALL)
HIDEPARAMETER

Interface Script

UI_DIALOG
UI_PAGE
UI_CURRENT_PAGE
UI_BUTTON (at UI_BUTTON, at UI_TOOLTIP)

UI_PREV
UI_NEXT
UI_FUNCTION
UI_LINK
UI_PICT_BUTTON (at UI_PICT_BUTTON, at UI_TOOLTIP)
UI_SEPARATOR
UI_GROUPBOX
UI_PICT (at UI_PICT, at UI_TOOLTIP)
UI_STYLE
UI_OUTFIELD (at UI_OUTFIELD, at UI_TOOLTIP)
UI_INFIELD (at UI_INFIELD, at UI_TOOLTIP)
UI_INFIELD{2} (at UI_INFIELD{2}, at UI_TOOLTIP)
UI_INFIELD{3} (at UI_INFIELD{3}, at UI_TOOLTIP)
UI_INFIELD{4} (at UI_INFIELD{4}, at UI_TOOLTIP)
UI_CUSTOM_POPUP_INFIELD (at UI_CUSTOM_POPUP_INFIELD, at UI_TOOLTIP)
UI_CUSTOM_POPUP_INFIELD{2} (at UI_CUSTOM_POPUP_INFIELD{2}, at UI_TOOLTIP)
UI_RADIOBUTTON (at UI_RADIOBUTTON, at UI_TOOLTIP)
UI_RADIOBUTTON{2}
UI_PICT_RADIOBUTTON
UI_PICT_RADIOBUTTON{2}
UI_PICT_PUSHCHECKBUTTON
UI_PICT_PUSHCHECKBUTTON{2}
UI_TEXTSTYLE_INFIELD
UI_TEXTSTYLE_INFIELD{2}
UI_LISTFIELD (at UI_LISTFIELD, at UI_TOOLTIP)
UI_LISTITEM (at UI_LISTITEM, at UI_TOOLTIP)
UI_LISTITEM{2} (at UI_LISTITEM{2}, at UI_TOOLTIP)
UI_CUSTOM_POPUP_LISTITEM (at UI_CUSTOM_POPUP_LISTITEM, at UI_TOOLTIP)
UI_CUSTOM_POPUP_LISTITEM{2} (at UI_CUSTOM_POPUP_LISTITEM{2}, at UI_TOOLTIP)
UI_TOOLTIP
UI_COLORPICKER
UI_COLORPICKER{2}
UI_SLIDER

```
UI_SLIDER{2}
```

Forward and Backward Migration Scripts

```
SETMIGRATIONGUID  
STORED_PAR_VALUE  
DELETED_PAR_VALUE  
NEWPARAMETER
```

GDL DATA I/O ADD-ON

The GDL Data In/Out Add-On allows you to access a simple kind of database by using GDL commands. Otherwise this Add-On is similar to the GDL Text In/Out Add-On.

Description of Database

The database is a text file in which the records are stored in separate lines. The database can be queried and modified based on a single key. The key and the other items are separated by a character (specified in the OPEN command).

The length of the lines does not need to be the same and even the number of columns in the records may be different.

If a database is open for writing then there should be enough space beside the database file for duplicating the whole file.

Opening and closing a database may be time consuming, so consecutive closing and opening of a database should be avoided.

Large databases (with more than some hundred thousand records) should be ordered by the key values.

A database can be opened, queried, modified and closed by this Add-On using the OPEN, INPUT, OUTPUT and CLOSE GDL commands.

Opening a Database

```
channel = OPEN (filter, filename, paramstring)
```

Opens the database. If the database file is to be opened for modification and the file does not exist, it creates a new file. If the database file is to be opened for reading and the file does not exist, an error message is displayed.

Its return value is a positive integer that will identify the specific database. This value will be the database's future reference number.

If the database is opened before open command, it will generate a channel number only.

filter: the internal name of the Add-On, in this case "DATA"

filename: the name of the database file to be opened

paramstring: add-on specific parameter, contains separator characters and file opening mode parameters

The paramstring may contain the following:

SEPARATOR: after the keyword between single quotation marks (") you can define a character that you want to use in your text file (both in case of writing and reading) for the separation of data fields. A special case is the tabulator character ('\t').

MODE: after the keyword the mode of opening has to follow. There are three modes of opening:

- RO (read only)
- WA (read, append/modify)
- WO (overwrite) Empties the database if exists.

DIALOG: the 'filename' parameter is working as a file-identifier, otherwise it is a full-path-name. The file-identifier is a simple string, which will be matched to an existing file by the Add-On during a standard 'Open/Save as' dialog. This matching is stored by the Add-On and it won't ask again except when the file is not available any more. If the open mode is read only, the Add-On will put up an Open dialog to select an existing document. Otherwise the Add-On put up an alert-dialog to select between the 'Create' and 'Browse' options:

- Create: create a new data-file (Save as Dialog).
- Browse: search an existing data-file (Open dialog)

LIBRARY: If the LIBRARY keyword is present in the parameter string, the data file has to be in the loaded library. Opening data file from the loaded library for reading is possible from all scripts, but writing is only enabled in the parameter, user interface and property scripts.

Always put a comma (,) between the components of paramstring.

If you use keywords that don't exist, if the separator characters given are wrong or if there is nothing in the parameter string, the extension will use the default settings: "SEPARATOR = '\t', MODE = RO"

Example:

```
ch1 = OPEN ("DATA", "file1",
           "SEPARATOR=';', MODE = RO, DIALOG")
ch2 = OPEN ("DATA", "file2", "")
ch3 = OPEN ("DATA", "newfile",
           "SEPARATOR = '\t', MODE = WA")
```

Reading Values from Database

INPUT (channel, recordID, fieldID, var1 [, var2, ...])

Queries the database based on the key value.

If it finds the record, it reads items from the record starting from the given column and puts the read values into the parameters in sequence.

In the parameter list there has to be at least one value. The values can be of numeric or string type independently of the parameter type defined for them. The return value is the number of successfully read values.

If there are more parameters than values, the parameters without corresponding values will be set to zero. In case of empty columns (i.e. if there is nothing between the separator characters) the parameters will be set to zero.

If it finds no record it returns (-1).

channel: channel value, used to identify the connection.

recordID: key value (numeric or string).

fieldID: the column number in the given record (the smallest number, 1 refers to the item after the key value).

vari: variables to receive the read record items.

Example:

```
! input of three values from the first column of the first row
nr = INPUT (ch1, "key1", 1, v1, v2, v3)

PRINT nr, v1, v2, v3
```

Writing Values into Database

```
OUTPUT channel, recordID, fieldID, expr1 [, expr2, ...]
```

In case of record creation or modification, it sets the record belonging to the given key value. The record will contain the given values in the same sequence as they appear in the command. The values can be of numeric or string type. There has to be at least one expression.

In case of deletion the record belonging to the given key value is removed from the database. The expression values are ignored, however at least one should be specified.

Modifying data files loaded with the library is only enabled in the parameter, user interface and property scripts.

recordID: key value (numeric or string)

fieldID: flag: specify 0 (or ≤ 0) to delete a record, specify 1 (or > 0) to create or modify a record

expr1: new item values of the found or new record. In case of deletion these values are ignored

Example:

```
string = "Date: 19.01.1996"
a = 1.5
OUTPUT ch2, "keyA", 1, "New record"
OUTPUT ch2, "keyA", 1, "Modified record"
OUTPUT ch2, "keyA", 0, 0 ! deletes the record
OUTPUT ch2, "keyB", 1, a, string
```

Closing Database

CLOSE channel

channel: channel value

Closes the database identified by the channel value.

GDL DATETIME ADD-ON

The DateTime extension allows you to set various formats for the current date and time set on your computer.

The Add-On works the same way the GDL file operations. You have to open a channel, read the information and close the channel.

This Add-On is also available by using the REQUEST GDL command, in which case the sequence of commands OPEN, INPUT and CLOSE is called internally. This is the simplest way to obtain the date/time information, with just a single GDL command line:

```
REQUEST ("DateTime", format_string, datetimestring)
```

The second parameter of the Request function is the same as that described in the OPEN function paramstring parameter.

Opening Channel

```
channel = OPEN (filter, filename, paramstring)
```

Its return value is a positive integer that will identify the opened channel. This value will become the channel's future reference number. The paramstring can contain specifiers and other characters.

filter: the internal name of the Add-On, in this case "DateTime"

filename: unused (there is no need to open any file to get the system date and time)

paramstring: add-on specific parameter, contains the desired output format of the date and time

The specifiers are replaced with date and time values as follows:

%y	year without century, as a decimal number (00-99)
%Y	year with century, as a decimal number
%b	abbreviated month name
%B	full month name
%m	month, as a decimal number (01-12)
%d	day of the month as a decimal number (01-31)
%H	hour (24-hour clock), as a decimal number (00-23)
%I	hour (12-hour clock), as a decimal number (01-12)
%M	minute, as a decimal number (00-59)
%S	second, as a decimal number (00-59)
%P	AM/PM designation for a 12-hour clock
%c	date and time in the form: 01:35:56 PM Wednesday, March 27, 1996
%x	date in the form Wednesday, March 27, 1996
%X	time in the form 01:35:56 PM
%a	abbreviated weekday name
%A	full weekday name
%w	weekday, as a decimal number (0 (Sunday)-6 (Saturday))
%j	day of the year, as a decimal number (001-366)
%U	week number of the year (with Sunday as the first day of the first week), as a decimal number
%W	week number of the year (with Monday as the first day of the first week), as a decimal number (00-53)
%Z	prints the time zone if it can be determined
%%	the % character

Example:

```
dstr = ""
ch = OPEN ("DateTime", "", "%w/%m/%d/%Y, %H:%M%P")
n = INPUT (ch, "", "", dstr)
CLOSE (ch)
PRINT dstr !it prints 3/03/27/1996, 14:36 PM
```

Reading Information

```
n = INPUT (channel, "", "", datetimestr)
```

It reads a string type value which represents the date and/or time in the format given at the OPEN sequence. The second and third parameters are unused (they can be empty strings or 0-s as well)

The return value is the number of successfully read values, in this case 1.

channel: channel value, used to identify the connection.

datetimestr: string type value

Closing Channel

```
CLOSE channel
```

Closes the channel identified by the channel value.

GDL FILE MANAGER I/O ADD-ON

The GDL File Manager In-Out Add-On allows you to scan a folder for the contained files/subfolders from a GDL script.

Specify the folder you would like to scan by using the OPEN command.

Get the first/next file/folder name in the specified folder by using the INPUT command.

Finish folder scanning by using the CLOSE command.

Specifying Folder

```
channel = OPEN (filter, filename, paramstring)
```

channel: folder id

filter: the internal name of the Add-On, in this case "FileMan"

filename: the name of folder to be scanned (OS dependent path) - folder id string (in DIALOG mode - see later)

paramstring: Add-on specific parameter. The parameters in paramString must be separated by commas (,).

1. **parameter: FILES/FOLDERS:** What would you like to search for?
2. **parameter (optional): DIALOG:** Indicates that the folder is given by a file id string instead of a file path. When this is the case, at the first time (and each time when the corresponding file path seems to be invalid) the user will be faced a dialog box to set the id string - file path correspondence, which will be stored.

Example: Opening the root directory of the C drive (on a PC) for file-scanning

```
folder = OPEN ("FileMan", "c:\", "FOLDERS")
```

Getting File/Folder Name

```
n = INPUT (channel, recordID, fieldID, var1 [, var2, ...])
```

channel: folder id (returned by the OPEN command)

recordID: 0 (reserved for further development)

fieldID: 0 (reserved for future development)

var1, ...: variable(s) to receive the file/folder name(s)

n: the number of successfully filled variables

Example: Fetching the next file name from the specified folder

```
n = INPUT (folder, 0, 0, fileName)
```

If it succeeds, n will be 1. If there are no more files/subfolders the variable n will be set to zero.

Finishing Folder Scanning

```
CLOSE (channel)
```

Closes the folder identified by the channel value.

Example: Listing a single folder

```
topFolder = open ("FileMan", "MyFavouriteFolder", "files, dialog")
```

```
y = 0
```

```
n = input (topFolder, 0, 0, fileName)
```

```
while n = 1 do
```

```
    text2 0, y, fileName
```

```
    y = y - 0.6
```

```
    n = input (topFolder, 0, 0, fileName)
```

```
endwhile
```

```
close (topFolder)
```

This code segment (as the 2D script section of an object, for example) lists the files in the folder specified by the MyFavouriteFolder identifier. At first usage, the user will have to assign an existing folder to this identifier. Later, MyFavouriteFolder id will represent that folder.

GDL TEXT I/O ADD-ON

The GDL Text In/Out Add-On allows you to open external text files for reading/writing and to manipulate them by putting/getting values from/to GDL scripts.

This Add-On interprets the strings on the parameter list of the OPEN, INPUT, OUTPUT commands from the GDL script.

The created files are placed in a subfolder of the application data folder if it is given by a relative path. The folder can contain subfolders where the extension will look for existing files. It can read and write TEXT type files.

Opening File

```
channel = OPEN (filter, filename, paramstring)
```

Opens the file. If the file into which you want to write doesn't exist, it creates the file. If a file to be read doesn't exist, an error message is displayed.

Its return value is a positive integer that will identify the specific file. This value will be the file's future reference number.

filter: the internal name of the Add-On, in this case "TEXT"

filename: the name of the file to be opened

paramstring: add-on specific parameter, contains separator characters and file opening mode parameters

The paramstring may contain the following:

SEPARATOR: after the keyword between apostrophes (') you can assign a character to use in the text file (for both writing and reading) to separate columns. Special cases are the tabulator ('\t') and the new row ('\n') characters.

MODE: the mode of opening has to follow this keyword. There are only three modes of opening:

- RO (read only)
- WA (write only, append at the end of the file)
- WO (write only, overwrite) the data previously stored in the file will be lost!

A file cannot be open for reading and writing at the same time.

DIALOG: If this keyword is present, a dialog box will appear in which you can enter a file name.

FULLPATH: If this keyword is present, the file name will be interpreted as a full path name.

LIBRARY: If this keyword is present, the data file must be in the loaded library. Opening data file from the loaded library for reading is possible from all scripts, but writing is only enabled in the parameter, user interface and property scripts.

Always put a comma (,) between the keywords.

NEWLINE: definition of new line character(s). Possible values:

- CR (Carriage return, 0x0D)
- LF (Line feed, 0x0A)
- CRLF (Carriage return + Line feed, 0x0D0x0A)

For Windows-like line ends use "NEWLINE = CRLF"

If you use keywords that don't exist, if the separator characters given are wrong or if there is nothing in the parameter string, the extension will use the default settings: "SEPARATOR = '\t', MODE = RO, NEWLINE = LF"

Example:

```
ch1 = OPEN ("TEXT", "file1", "SEPARATOR = ';' , MODE = RO")
ch2 = OPEN ("TEXT", "file2", "")
ch3 = OPEN ("TEXT", "file3", "SEPARATOR = '\n' , MODE = WO")
```

Reading Values

```
INPUT (channel, recordID, fieldID, var1 [, var2, ...])
```

It reads as many values from the given starting position of the file identified by the channel value as many parameters are given. In the parameter list there has to be at least one value. The function puts the read values into the parameters in sequence. The values can be of numeric or string type independently of the parameter type defined for them.

The return value is the number of successfully read values, in case of end of file (-1).

Both the row and the column numbers have to be positive integers, otherwise you will get an error message.

If the row or column numbers are incorrect, the input will not be carried out. (n = 0)

If the row and the column can be identified, as many values shall be input from the given starting position as many parameters are given, or if there are more parameters than values, the parameters without corresponding values will be set to zero.

In case of empty columns (i.e. if there is nothing between the separator characters) the parameters will be set to zero.

channel: channel value, used to identify the connection.

recordID: the row number (numeric or string)

fieldID: the column number in the given row

var1, ...: variables to receive the read record items

Example:

```
nr = INPUT (ch1, 1, 1, v1, v2, v3) ! input of three values
! from the firstcolumn of the first row
PRINT nr, v1, v2, v3
```

Writing Values

`OUTPUT channel, recordID, fieldID, expr1 [, expr2, ...]`

Outputs as many values into the file identified by the channel value from the given position as many expressions are defined. There has to be at least one expression. The types of the output values are the same as those of the expressions.

In case of a text extension, the OUTPUT will either (depending on the mode of opening) overwrite the file or add to the end of the file the given expressions to consecutive positions using between them the separator characters defined when opening the file. In this case, the given position is not interpreted.

Modifying data files loaded with the library is only enabled in the parameter, user interface and property scripts.

channel: channel value

recordID: The recordID is used to direct the new rows in the output

If the recordID is positive, the output values will be followed by a new row, otherwise the last value will be followed by a separator character.

fieldID: no role, its value is not used

expr1: values to output

Example:

```
string = "Date: 19.01.1996"
```

```
a = 1.5
```

```
OUTPUT ch2, 1, 0, string ! string followed by a new row
```

```
OUTPUT ch2, 0, 0, a, a + 1, a + 2! separator character after a + 2 ! without new row
```

Closing File

`CLOSE channel`

Closes the text file identified by the channel value.

channel: channel value

Example:

A GDL object that will simply copy the contents of the "f1" file both into the "f2" and the "f3" files, but will write all the values tabulated in "f1" into a separate row in both "f2" and "f3".

```

ch1 = open ("TEXT", "f1", "mode = ro")
ch2 = open ("TEXT", "f2", "separator = '\n', mode = wo")
ch3 = open ("TEXT", "f3", "separator = '\n', mode = wo")
i = 1

1:
  n = input (ch1, i, 1, var1, var2, var3, var4)
  if n <> -1 then
    output ch2, 1, 0, var1, var2, var3, var4
    output ch3, 1, 0, var1, var2, var3, var4
    i = i + 1
    goto 1
  else
    goto "close all"
  endif

"close all":
  close ch1
  close ch2
  close ch3
end

```

PROPERTY GDL ADD-ON

The purpose of this add-on is to make an ARCHICAD property database accessible from GDL scripts. You can open database tables and query their contents, just like you would do it with SQL. You can query single records and multiple records (lists). Note that you cannot modify the database, and you cannot append records to it.

For the detailed description of the property database please refer to the “ARCHICAD Calculation Guide” in the Help menu.

Open property database

```
OPEN ("PROP", "database set name", "[database files]")
```

Return value: channel number

Opens a communication channel to the given database files. The content of the database files are read into memory for faster access. As long as it is open modifications to the property database will not be accessible from this add-on. This is usually not a problem though.

database set name: an arbitrary name that will identify a set of database files in subsequent OPEN calls.

database files: a list of text files that are part of the property database. This parameter is optional, if you have previously assigned `database set name` to the files you would like to read. The order of the files is fixed: `key file`, `component file`, `descriptor file`, `unit file`. You don't need to give full paths, because ARCHICAD will look up these files for you in the active libraries. If you use long filenames or names with spaces, put them between quotes (' or ").

Example 1:

```
channel = OPEN ("PROP", "sample",
               "'ArchiCAD_Library_KEY.txt', 'ArchiCAD_Library_COMP.txt',
               'ArchiCAD_Library_DESC.txt', 'ArchiCAD_Library_UNIT.txt'")
```

Opens a database that consists of the files above (those are the files of the ARCHICAD Property database), and names it "sample". Note that inside the third parameter you must use a different quotation character (you can use " and ').

Example 2:

```
channel = OPEN ("PROP", "sample", "")
```

This command can be issued after explicitly opening the database files (like in example 1), but before closing it. This lets you use the explicit command at one place in the Master_GDL script, and use the shorter version later.

Close property database

```
CLOSE (channel_number)
```

Return value: none

Closes the previously opened communication channel.

Input to property database

```
INPUT (channel_number, "query type", "field list", variable1 [, ...])
```

channel_number: a valid communication channel number given by a previous OPEN command.

query type: specifies the query you would like to execute. The add-on understands the following keywords:

- Single-record queries:
 - KEY, <keycode> - query the record from the key database where <keycode> is the value of the keycode attribute. Valid fields: KEYCODE, KEYNAME
 - UNIT, <unitcode> - query the record from the unit database where <unitcode> is the value of the unit code attribute. Valid fields: UNITCODE, UNITNAME, UNITFORMATSTR

- COMP, <keycode>, <code> - query the record from the unit database where <keycode> is the key code attribute value, and <code> is the component code attribute value. Valid fields: KEYCODE, KEYNAME, CODE, NAME, QUANTITY, QUANTITYSTR, UNITCODE, UNITNAME, UNITFORMATSTR
- DESC, <keycode>, <code> - query the record from the unit database where <keycode> is the key code attribute value, and <code> is the descriptor code attribute value. Valid fields: KEYCODE, KEYNAME, CODE, NAME, NUMOFLINES, FULLNAME
- Listing queries:
 - KEYLIST - list all records in the key database. Valid fields: KEYCODE, KEYNAME
 - UNITLIST - list all records in the unit database. Valid fields: UNITCODE, UNITNAME, UNITFORMATSTR
 - COMPLIST[, <keycode>] - list all records in the component database, or if <keycode> is given, then only those records are listed whose keycode equals <keycode>. Valid fields: KEYCODE, KEYNAME, CODE, NAME, QUANTITY, QUANTITYSTR, UNITCODE, UNITNAME, UNITFORMATSTR
 - DESCLIST[, keycode] - list all records in the descriptor database, or if <keycode> is given, then only those records are listed whose keycode equals <keycode>. Valid fields: KEYCODE, KEYNAME, CODE, NAME, NUMOFLINES, FULLNAME
 - COMPDESCLIST[, <keycode>] - list all records in the component and the descriptor database, or if <keycode> is given, then only those records are listed whose keycode equals <keycode>. Valid fields: ISCOMP, KEYCODE, KEYNAME, CODE, NAME, QUANTITY, QUANTITYSTR, UNITCODE, UNITNAME, UNITFORMATSTR, NUMOFLINES, FULLNAME

Use this query with care! If either field is not valid in a database (e.g. FULLNAME in the component database) it will be simply left out from the resulting list (you should be aware of that)

field list: lists the database attributes whose values you would like to see in the output. If the output is a list, it will be sorted in the order of the fields listed here.

The following fields can be used:

- KEYCODE - key code attribute. Type: string. Usable in queries: KEY, COMP, DESC, KEYLIST, COMPLIST, DESCLIST, COMPDESCLIST
- KEYNAME - key name attribute. Type: string. Usable in queries: KEY, COMP, DESC, KEYLIST, COMPLIST, DESCLIST, COMPDESCLIST.
- UNITCODE - unit code attribute. Type: string. Usable in queries: UNIT, COMP, UNITLIST, COMPLIST, COMPDESCLIST
- UNITNAME - unit name attribute. Type: string. Usable in queries: UNIT, COMP, UNITLIST, COMPLIST, COMPDESCLIST
- UNITFORMATSTR - GDL format string of the unit. Type: string. Usable in queries: UNIT, COMP, UNITLIST, COMPLIST, COMPDESCLIST.
- CODE - component or descriptor code attribute (depends on the query). Type: string. Usable in queries: COMP, DESC, COMPLIST, DESCLIST, COMPDESCLIST.

- NAME - name of component or the first line of a descriptor record. Type: string. Usable in queries: COMP, DESC, COMPLIST, DESCLIST, COMPDESCLIST.
- QUANTITY - quantity of a component as a number (for calculations). Type: number. Usable in queries: COMP, COMPLIST, COMPDESCLIST.
- QUANTITYSTR - quantity of a component in string format. Type: string. Usable in queries: COMP, COMPLIST, COMPDESCLIST.
- NUMOFLINES - number of lines in a descriptor record. Type: number. Usable in queries: DESC, DESCLIST.
- FULLNAME - the whole descriptor record. Type: string(s). Usable in queries: DESC, DESCLIST.
- ISCOMP - tells you whether the next record is a component or a descriptor. Type: number (1 if component, 0 if descriptor). Usable in queries: COMPDESCLIST

variables: will hold the result of the query upon completion. You can list several variables if you know exactly how many you need (e.g. with single queries) or you can specify a dynamic array. The records are listed sequentially.

Example 1:

```
INPUT (channel, "KEY, 001", "KEYNAME", keyname)
```

This is a simple query: the name of the key with "001" code is put into the keyname variable.

Example 2:

```
INPUT (channel, "DESC, 004, 10", "NUMOFLINES, FULLNAME", desc_txt)
```

The descriptor record with keycode "004" and code "10" is processed, the number of lines of the description text and the text itself is put into the desc_txt array. The result is:

```
desc_txt[1] = <numoflines> (number)
```

```
desc_txt[2] = <first row of description> (string)
```

```
...
```

```
desc_txt[<numoflines+1>] = <last row of description>
```

Example 3:

```
INPUT (channel, "COMPLIST", "NAME, KEYNAME, QUANTITY", comp_list)
```

Create a component list, sort it by the name field, then by the keyname and finally by the quantity field and put it into the comp_list array. The result is:

```
complist[1] = <name1> (string)
```

```
complist[2] = <keyname1> (string)
```

```
complist[3] = <quantity1> (number)
```

complist[4] = <name2> (string)

... etc.

Example 4:

```
INPUT (channel, "COMPDESCLIST, 005", "ISCOMP, KEYNAME, NAME, QUANTITY", x_list)
```

Creates a common component and descriptor list, which means that records from both tables are listed where <keycode> is "005". The output is:

x_list[1] = 0 (number, 0 -> it is a descriptor)

x_list[2] = <name1> (string -> descriptors do not have <keyname> field, so it is left out)

x_list[3] = 0 (number, descriptors do not have quantity field)

...

x_list[(n*2)-1] = 1 (number -> there were n-1 descriptors listed, now the components come)

x_list[n*2] = <keyname_n> (string) ... etc.

Output to property database

This command is not implemented in this add-on, since property databases are read-only.

GDL XML EXTENSION

This extension allows reading, writing and editing XML files. It implements a subset of the Document Object Model (DOM) interface. XML is a text file that uses tags to structure data into a hierarchical system, similar to HTML. An XML document can be modeled by a hierarchical tree structure whose nodes contain the data of the document. The following node types are known by the extension:

- *Element*: what is between a start-tag and an end-tag in the document, or for an empty-element it can be an empty-element tag. Elements have a name, may have attributes, and usually but not necessarily have content. It means that element type nodes can have child nodes. Attributes are held in an attribute list where each attribute has a different name and a text value.
- *Text*: a character sequence. It cannot have child nodes.
- *Comment*: text between the comment delimiters: <!-- the comment itself --> . In the text of the comment each '-' character must be followed by a character different from '-'. It also means that the following is illegal: <!-- comment ---> . Comment type nodes cannot have child nodes.
- *CDATASection*: text between the CDATA section delimiters: <![CDATA[the text itself]]> . In a CDATA section characters that have special meaning in an XML document need not (and must not) be escaped. The only markup recognized is the closing "]]>". CDATA section nodes cannot have child nodes.
- *Entity-reference*: reference to a predefined entity. Such a node can have a read-only subtree and this subtree gives the value of the referenced entity. During the parsing of the document it can be chosen that entity references are translated into text nodes.

On the top level it is obligatory to have exactly one element type node (the root), and there can be several comment type nodes, as well. The document type node of the DOM interface is not available through the extension's interface.

	name	value
Element	name of the tag	"" (empty string)
Text	"#text"	the text content of the node
Comment	"#comment"	the text content of the node
CDATASection	"#cdata-section"	the text content of the node
Entity-reference	name of the referenced entity	"" (empty string)

For each node in the tree there is a name and a value string associated whose meanings depend on the type of the node:

Element:	ELEM
Text:	TXT
Comment:	CMT
CDATA section:	CDATA
Entity reference:	EREF

The success or error code of an OPEN, INPUT or OUTPUT command can be retrieved by the GetLastError instruction of the INPUT command.

Opening an XML Document

channel = OPEN (filter, filename, parameter_string)

filter: file extension. This should be 'XML'.

filename: name and path of the file to open (or create), or an identifier name if the file is opened through a dialog box and the file's location is given by the user.

parameter_string: a sequence of character flags that determine the open-mode:

'r': open in read-only mode. In general only the INPUT command can be used.

'e': entity references are not translated into text nodes in the tree. Without this flag there are no entity-references in the document structure.

'v': validity check is performed during reading in and writing out. If a DTD exists in the document, the document's structure must agree with it. Without this flag a well-structured but invalid document can be read in and written out without error message.

- 'n': create a new file. If the file exists, the open will fail. (After the OPEN the CreateDocument instruction must be the first to execute.)
- 'w': overwrite file with empty document if it exists. If it doesn't exist, a new file will be created. (After the OPEN the CreateDocument instruction must be the first to execute.)
- 'd': the file is obtained from the user in a dialog box. In later runs it will be associated with the identifier given in the filename parameter of the OPEN command. (If the identifier is already associated to a file, the dialog box will not be opened to the user.)
- 'f': the filename parameter contains a full path.
- 'l': the file is in the loaded library parts. Opening data file from the loaded library for reading is possible from all scripts, but writing is only enabled in the parameter, user interface and property scripts.

channel: used to identify the connection in subsequent I/O commands.

If you want to open an existing XML file for modification, then none of the 'r', 'n' and 'w' flags must be set in the parameter string. Only one of the 'd', 'f' and 'l' flags should be set. If none of these flags is set then filename is considered to be a path relative to the user's documents folder.

Reading an XML Document

DOM is an object-oriented model that cannot be adapted to a BASIC-like language like GDL directly. To represent the nodes in the hierarchy tree we define position descriptors. When we want to walk through the nodes of the tree, first we have to request a new position descriptor from the extension. Originally a new descriptor points to the root element. The descriptor is in fact a 32 bit identification number whose value has no interest for the GDL script. The position it refers to can be changed as we move from one node in the tree to another.

```
n = INPUT (ch, recordID, fieldID, var1, var2, ...)
```

ch: channel returned by the OPEN command.

recordID: instruction name plus parameters.

fieldID: usually a position descriptor.

var1, var2, ...: optional list of variables receiving returned data.

INPUT instructions:

- **GetLastError:** retrieve the result of the last operation
 - recordID: "GetLastError"
 - fieldID: ignored
 - return values:
 - var1: error code / ok
 - var2: the explanation text of error / ok
- **NewPositionDesc:** request for a new position descriptor

recordID: "NewPositionDesc"

fieldID: ignored

return value: var1: the new position descriptor (initially refers to the root)

- **CopyPositionDesc:** request for a new position descriptor whose starting node is taken from another descriptor.

recordID: "CopyPositionDesc"

fieldID: an existing position descriptor

return value: var1: the new position descriptor (initially refers to where the descriptor given in fieldID refers to)

- **ReturnPositionDesc:** when a position descriptor is no longer needed.

recordID: "ReturnPositionDesc"

fieldID: the position descriptor

var1: ignored

Call this instruction when a position descriptor received from the NewPositionDesc or CopyPositionDesc instructions is no longer used.

- **MoveToNode:** change the position of a descriptor. (and retrieve the data of the new node)

This instruction can be used for navigating in the tree hierarchy.

recordID: "MoveToNode searchmode nodename nodetype nodenumber"

fieldID: position descriptor

searchmode (or movemode): the nodename parameter must contain a path that determines an element or entity reference node in the xml document.

To specify an exact path, the Path movemode should be used. After this movemode only the required path should be present.

The path is relative to the node given in fieldID. The delimiter is the '!' character (which is otherwise an accepted character in an element's name so this doesn't work for all cases). The '..' string in the path means a step to the parent node. The starting node can be different from an element or entity reference node, in which case the path must begin with '..' to step back. If there are several element nodes on the same level with the same name then the first one is chosen.

Move-modes:

ToParent: moves to the parent of the node given in fieldID.

ToNextSibling: moves to the next node on the same level.

ToPrevSibling: moves to the previous node on the same level.

ToFirstChild: moves to the first descendant of the fieldID node.

ToLastChild: moves to the last descendant of the fieldID node.

Search-modes:

FromNextSibling: searching starts from the next node on the same level and it moves forward.

FromPrevSibling: searching starts from the node before fieldID and it moves backward on the same level.

FromFirstChild: searching starts from the first descendant of the fieldID node and moves forward.

FromLastChild: searching starts from the last descendant of the fieldID node and moves backward.

nodename: the searching considers those nodes only whose name or value matches nodename. The * and ? characters in nodename are considered as wildcard characters. For element and entity reference type nodes the name is compared, while for text, comment and CDATA section nodes the value is compared. Default value: *

nodetype: the searching considers those nodes only whose type is allowed by nodetype. The * means all types are allowed. Otherwise the type keywords can be combined with the + character to form the nodetype (it must be one word without spaces, like TXT+CDATA.) The default value is *

nodenumber: if there are several matching nodes, this gives the number of the searched node in the sequence of matching nodes. (Starts from 1) Default value: 1

return values:

var1: name of the node

var2: value of the node

var3: type keyword of the node

Example:

We want to move backwards on the same level to the 2nd node that is an element or an entity reference and whose name starts with K:

```
n = INPUT (ch, "MoveToNode FromPrevSibling K* ELEM+EREF 2", posDesc, name, val, type)
```

- **GetNodeData:** retrieve the data of a given node.

```
recordID: "GetNodeData"
```

fieldID: the position descriptor

return values:

var1: name of the node

var2: value of the node

var3: type keyword of the node

- **NumberOfChildNodes:** gives the number of child nodes of a given node

recordID: "NumberofChildNodes nodetype nodename"

The following optional parameters can narrow the set of child nodes considered:

nodetype: allowed node types as defined in the MoveToNode instruction

nodename: allowed node names or values as defined in the MoveToNode instruction

fieldID: position descriptor

return values:

var1: number of child nodes

- **NumberofAttributes:** returns the number of attributes of an element node.

recordID: "NumberofAttributes attrname"

attrname: if present, it can narrow the set of attributes considered as only those attributes will be counted whose names (and not the values) match attrname. In attrname the * and ? characters are considered wildcard characters.

fieldID: position descriptor (must refer to an element node)

return values:

var1: number of attributes

- **GetAttribute:** return the data of an attribute of an element node

recordID: "GetAttribute attrname attrnumber"

fieldID: position descriptor (must refer to an element node)

optional parameters:

attrname: give the name of the attribute. The * and ? are considered wildcard characters. Default value: *

attrnumber: If several attribute matches attrname, attrnumber chooses the attribute in the sequence of matching attributes. (Counting starts from 1.) Default value: 1

return values:

var1: value of the attribute

var2: name of the attribute

- **Validate:** check the validity of the document.

The validity is not checked during a document modification instruction. It is checked during writing back the file to disk if the 'v' flag was set in the open-mode string. A validity check can be forced any time by the Validate instruction, however it can consume considerable amount of time and memory so it is not advisable to do so after every modification.

recordID: "Validate"

fieldID: ignored

var1: ignored

Modifying an XML Document

OUTPUT ch, recordID, fieldID, var1, var2, ...

ch: channel returned by the OPEN command.

recordID: instruction name plus parameters.

fieldID: usually a position descriptor.

var1, var2, ...: additional input data.

OUTPUT instructions:

Most of the OUTPUT instructions are invalid for files opened in read-only mode.

This instruction can be called even if the file was opened in read-only mode. In this case after the execution the document loses the read-only attribute, so it can be modified and saved to the new file location.

- **CreateDocument:**

recordID: "CreateDocument"

fieldID: ignored

var1: name of the document. This will be the tagname of the root element, as well.

CreateDocument is allowed only if the file was opened in new-file or overwrite mode. In these modes this instruction must be the first to be executed in order to create the XML document.

- **NewElement:** insert a new element type node in the document

recordID: "NewElement insertpos"

fieldID: a position descriptor relative to which the new node is inserted

var1: name of the new element (element tag-name)

insertpos can be:

AsNextSibling: new element is inserted after the position given in fieldID

AsPrevSibling: new element is inserted before the position given in fieldID

AsFirstChild: new element is inserted as the first child of the node given in fieldID (which must be an element node)

AsLastChild: new element is inserted as the last child of the node given in fieldID (which must be an element node)

- **NewText:** insert a new text node in the document

recordID: "NewText insertpos"

fieldID: position descriptor

var1: text to be inserted

See also the NewElement.

- **NewComment:** insert a new comment node in the document

recordID: "NewComment insertpos"

fieldID: position descriptor

var1: text of the comment to be inserted

See also the NewElement.

- **NewCDATASection:** insert a new CDATA section node in the document

recordID: "NewCDATASection insertpos"

fieldID: position descriptor

var1: text of the CDATA section to be inserted

See also the NewElement.

- **Copy:** make a copy of a subtree of the document under some node

recordID: "Copy insertpos"

fieldID: position descriptor relative to which the subtree is inserted

var1: position descriptor giving the node of the subtree to be copied

insertpos: same as in the *NewElement*

The copied subtree remains unchanged. Position descriptors pointing to a certain node in the copied subtree will point to the same node after the copy.

- **Move:** replace some subtree in the document to some other location

recordID: "Move insertpos"

fieldID: position descriptor relative to which the subtree is inserted

var1: position descriptor giving the node of the subtree to be moved

insertpos: same as in the *NewElement*

The original subtree is deleted. Position descriptors pointing to some node in the moved subtree will point to the same node in the new position of the subtree.

- **Delete:** delete a node and its subtree from the document

recordID: "Delete"

fieldID: position descriptor giving the node to delete

var1: ignored

All position descriptors pointing to some node in the deleted subtree become invalid.

- **SetNodeValue:** change the value of a node

recordID: "SetNodeValue"

fieldID: position descriptor, it must refer to either a text, a comment or a CDATA section type node

var1: new text value of the node

- **SetAttribute:** change an attribute of an element node or create a new one

recordID: "SetAttribute"

fieldID: position descriptor, it must refer to an element type node

var1: name of the attribute

var2: text value of the attribute

If the element already has an attribute with this name then its value is changed, otherwise a new attribute is added to the element's list of attributes.

- **RemoveAttribute:** removes an attribute of an element node

recordID: "RemoveAttribute"

fieldID: position descriptor, it must refer to an element type node

var1: name of the attribute to remove

- **Flush:** write the current document back to file

recordID: "Flush"

fieldID: ignored

var1: ignored

If the file was opened in validate mode, then only a valid document is saved.

- **ChangeFileName:** associate another file with the current document

recordID: "ChangeFileName"

fieldID: new file path

var1: gives how fieldID should be interpreted. If var1 is an empty string, fieldID contains a path relative to the user's documents folder. 'd' means the file's location is obtained from the user from a file dialog box (see open-mode flags in the section called “Opening an XML Document”). 'l' means the file is taken from the loaded libraries. 'f' means fieldID contains a full path.

Table 14. Error codes and messages (possible return values of OPEN function)

0	"Ok"
-1	"Add-on Initialization Failed"
-2	"Not Enough Memory"
-3	"Wrong Parameter String"
-4	"File Dialog Error"
-5	"File Does Not Exist"
-6	"XML Parse Error"
-7	"File Operation Error"
-8	"File Already Exists"
-9	"This channel is not open"
-10	"Syntax Error"
-11	"Open Error"
-12	"Invalid Position Descriptor"
-13	"Invalid Node Type for this Operation"
-14	"No Such Node Found"
-15	"Internal Error"
-16	"Parameter Error"
-17	"No Such Attribute Found"
-18	"Invalid XML Document"
-19	"Unhandled Exception"

-20	"Read-Only Document"
-21	"CreateDocument Not Allowed"
-22	"Document Creation Failed"
-23	"Setting NodeValue Failed"
-24	"Move Not Allowed"
-25	"Delete Not Allowed"
-26	"SetAttribute Not Allowed"
-27	"Format File Error"
-28	"Insertion (or Copy) Not Allowed"
-29	"Node Creation Failed"
-30	"Bad String"
-31	"Invalid Name"

POLYGON OPERATIONS EXTENSION

This add-on calculates result polygons based on the input polygons and the operation that is carried out on them.

Compatibility: introduced in ARCHICAD 21: There are operations for polylines as well.

Input polygons are identified by a name when passed to the add-on and are stored in a previously defined container. Result polygons are automatically named by the add-on and are stored in a second, target container. Input and result polygons are thus stored in different containers.

Multiple polygons, possibly with an even greater number of contours, can be created by a single operation. These will be administered as individual polygons in the target container. As a result, these polygons can be accessed in subsequent polygon operations. The principle is the same as with the Solid Geometry Commands (see in the section called “Solid Geometry Commands”). Input polygons must be contiguous.

A polygon is defined by several contours, each of which is an uninterrupted sequence of connected vertices. The first contour is the outer boundary. The subsequent contours must all be inside the first, they may not overlap, and they create cutouts of the first polygon.

Polylines don't have to be closed, but can't have multiple contours.

Opening a channel

```
ch = INITADDONSCOPE ("PolyOperations", "", "")
```

Opens a channel. The return value is the ID of the opened channel.

Container management

CreateContainer

Creates a new container.

```
PREPAREFUNCTION ch, "CreateContainer", "myContainer", ""
```

DeleteContainer

Delete an existing container.

```
PREPAREFUNCTION ch, "DeleteContainer", "myContainer", ""
```

EmptyContainer

Emptying an existing container.

```
PREPAREFUNCTION ch, "EmptyContainer", "myContainer", ""
```

SetSourceContainer

Set container as source container.

```
PREPAREFUNCTION ch, "SetSourceContainer", "mySourceContainer", ""
```

SetDestinationContainer

Set container as destination container.

```
PREPAREFUNCTION ch, "SetDestinationContainer", "myDestinationContainer", ""
```

Polygon / polyline management

The geometry can be communicated in two data formats: arrays or dictionaries. *Compatibility: introduced in ARCHICAD 23.*

The same exact geometry can be stored/retrieved in both ways.

Array

The array format is three separate arrays (they can have any name, they are identified by their position in the function parameter list):

contourArray: Only needed for polygons, not polylines. An array which contains the index of the last vertex of each contour in **vertArray**. Given with *"Store"*, returned from *"GetContourEnds"*.

vertArray: Array containing all vertices describing all contours of the polygon / polyline. Two-dimensional array to use with *"Store"* and *"StorePolyline"*, one-dimensional (flattened two-dimensional) array returned from *"GetVertices"* and *"GetPolylineVertices"*.

inhEdgeInfosArray: Optional array containing information attached to edges, defined by the caller. It must contain the same number of vertices as **vertArray**. Given with *"Store"* and *"StorePolyline"*, returned from *"GetInhEdgeInfos"* and *"GetPolylineInhEdgeInfos"*.

Dictionary

The dictionary format is more simple to handle (it can have any name, it is identified by its position in the function parameter list):

- .isClosed:** (boolean) 1 - polygon or closed polyline, 0 - open polyline (the last point given as an extra edge)
- .useEdgeInfo:** (boolean, optional) when set to 1, PolyOperations expects the **.edgeInfo** key, otherwise disregards it
- .defaultInhEdgeInfo:** (integer, optional) corresponds to the **defaultInhEdgeInfo** parameter of *"Store"*
- .contour:** (dictionary) contains data of the polygon contour, corresponding to **vertArray**
- .contour.edges[n]:** (array) contains an embedded dictionary for each edge of the polygon
- .contour.edges[n].type:** (integer) 0 - straight, 1 - curved (circular arc)
- .contour.edges[n].begPoint:** (dictionary) an embedded dictionary for the beginning point of the edge
- .contour.edges[n].begPoint.x / .y:** (float) coordinates
- .contour.edges[n].arcAngle:** (angle) central angle of the edge curve, positive counter-clockwise, negative clockwise (not set for straight edges)
- .contour.edges[n].edgeInfo:** (integer, optional) information attached to the edge
- .holes[m]:** (array, optional) contains data of inner holes, similar to **.contour**, only set when hole(s) exist

Some global variables use a dictionary structure that is compatible with PolyOperations (eg. *OPENING_SYMBOL_GEOMETRY.polygon2D*)

The same data format can be used for *"StoreDictPolygon"* and *"StoreDictPolyline"*.

Polylines never have **.holes[]**, polygons are always **.isClosed = 1**

Store

Stores the polygon "poly1" with the given parameters in the actual source container.

```
PREPAREFUNCTION ch, "Store", "poly1", nVertices, nContours,
vertArray, contourArray [, defaultInhEdgeInfo, inhEdgeInfosArray]
```

poly1: name of the stored polygon

nVertices: number of vertices

nContours: number of contours

vertArray: Array containing exactly nVertices items that describes all contours of the polygon. Two dimension array of (x, y, angle) records where x, y, and angle is real value. The angle parameter is the view-angle (deflection) in case of curved edges. This is a signed value, reflecting the orientation. Zero value means straight edge.

contourArray: An array which contains the index of the last vertex of the i-th contour. It must have exactly nContours items.

defaultInhEdgeInfo: One piece of inherited edge information. To the brand new edges (not created with split) this information will be attached in operations performed. This data helps tracing newly created edges after complex operations. (Optional)

inhEdgeInfosArray: Array containing information attached to edges. It must contain exactly nVertices integer type items. If an edge splits into more than one new edge in an operation, this information will be inherited without change to all new edges created. Can be used to store the side angles of a roof, for example. (Optional)

Remarks:

- Polygons can have holes and curved edges though these curved edges can be only circle-arcs.
- The polygon can link to additional data for every edge.
- The first vertex must be always repeated in the last for all contours. So in this representation, a triangle have four vertices, where the first and the last vertex is identical.
- The first contour is the main contour, and it must contain the others.

StorePolyline

Stores the polyline "polyline1" with the given parameters in the actual source container.

```
PREPAREFUNCTION ch, "StorePolyline", "polyline1", nVertices,
vertArray, [, defaultInhEdgeInfo, inhEdgeInfosArray]
```

polyline1: name of the stored polyline

nVertices: number of vertices

vertArray: Array containing exactly nVertices items that describes the polyline. Two dimension array of (x, y, angle) records where x, y, and angle is real value. The angle parameter is the view-angle (deflection) in case of curved edges. This is a signed value, reflecting the orientation. Zero value means straight edge.

defaultInhEdgeInfo: One piece of inherited edge information. To the brand new edges (not created with split) this information will be attached in operations performed. This data helps tracing newly created edges after complex operations. (Optional)

inhEdgeInfosArray: Array containing information attached to edges. It must contain exactly nVertices integer type items. If an edge splits into more than one new edge in an operation, this information will be inherited without change to all new edges created. Can be used to store the side angles of a roof, for example. (Optional)

Remarks:

- The polyline can link to additional data for every edge.
- To define a closed polyline, the last vertex coordinates has to be the same as the first. Open and closed polylines behave differently when being offset or split.

StoreDictPolygon

Stores the polygon "poly1" described as a dictionary in the actual source container. *Compatibility: introduced in ARCHICAD 23.*

```
PREPAREFUNCTION ch, "StoreDictPolygon", "poly1", PolyOpPolygon
```

poly1: name of the stored polygon

PolyOpPolygon: polygon as dictionary

StoreDictPolyline

Stores the polyline "polyline1" described as a dictionary in the actual source container. *Compatibility: introduced in ARCHICAD 23.*

```
PREPAREFUNCTION ch, "StoreDictPolyline", "polyline1", PolyOpPolyline
```

polyline1: name of the stored polyline

PolyOpPolyline: polyline as dictionary

Dispose

Deletes the polygon / polyline "poly1" from the container "myContainer".

```
PREPAREFUNCTION ch, "Dispose", "poly1", "myContainer"
```

Polygon / polyline operation settings

These commands work the same regardless whether data was given in dictionary or array format.

HalfPlaneParams

Set the half plane in 2D to be used in the "*PolyCut*" operation.

```
PREPAREFUNCTION ch, "HalfPlaneParams", "", ca, cb, cc
```

Defining inequality for the half plane: $ca * x + cb * y > cc$.

ca: Coefficient of x

cb: Coefficient of y

cc: Constant

OffsetParams

Set the offset parameters used in "OffsetEdge", "ResizeContour" and "PolylineOffsetVectors" operations.

PREPAREFUNCTION ch, "OffsetParams", "", itemIdx, offsetValue

itemIdx: Index of the edge to be translated for "OffsetEdge" operation. Index of the resizable contour for "ResizeContour" operation. Always 1 for "PolylineOffsetVectors" operation.

offsetValue: Distance of the translation. Negative and positive offset values make the edge move inside and outside, respectively. If the offset is big, the neighboring vertices can be cut out.

MultipleEdgeOffsetParams

Set the offset parameters used in "OffsetMultipleEdges" and "PolylineOffsetVectors" operations.

PREPAREFUNCTION ch, "MultipleEdgeOffsetParams", "", nOffset, offsetArray

nOffset: Number of edges to offset.

offsetArray: Array containing nOffset items that describe edges to offset. Two dimensional array of (edgeIndex, offsetValue) records, where edgeIndex is 1-based index of the edge, offsetValue is the distance of translation. For open polylines, it is positive to the left, negative to the right (viewed in the direction of the edge).

PolylineOffsetVectors

Set the end offset parameters used in "OffsetPolylineWithVectors" operation. "OffsetParams" or "MultipleEdgeOffsetParams" have to be set separately.

PREPAREFUNCTION ch, "PolylineOffsetVectors", "", sx, sy, ex, ey

sx, sy: Start vertex offset direction vector. (*Compatibility: has to be a unit vector up till version ARCHICAD 21.*)

ex, ey: End vertex offset direction vector. (*Compatibility: has to be a unit vector up till version ARCHICAD 21.*)

Polygon / polyline operations

These functions work the same regardless whether data was given in dictionary or array format.

In the following polygon operations the "poly1", "poly2" source polygons and "polyline1" source polyline are located in the source container. The resulting polygons / polylines are stored in the destination container with a unique name started with "resPolygonID" or "resPolylineID", where "ID" is a number. These names are generally returned in an array.

+ - /

Executes the "OP" operation with "poly1" and "poly2" polygons and puts the new values into the given parameters. The return value is the number of the generated polygons

```
dim resPolyIDArray[]
nPgon = CALLFUNCTION (ch, "poly1 OP poly2", "", resPolyIDArray)
```

OP: can be:

- + : Polygon addition
- : Polygon subtraction
- / : Polygon intersection

resPolyIDArray: Array of resulting polygon identifiers.

ClipPolyline

Clip a polyline with a polygon

```
dim resPolyIDArray[]
nPline = CALLFUNCTION (ch, "ClipPolyline", "polyline1 poly1", resPolyIDArray)
```

polyline1: Name of the polyline in the source container.

poly1: Name of the clip polygon in the source container.

resPolyIDArray: Array of resulting polyline identifiers.

CopyPolygon

Copying a polygon / polyline from the source container to the destination container

```
dim resPolyIDArray[]
nPgon = CALLFUNCTION (ch, "CopyPolygon", "poly1", resPolyIDArray)
```

Regularize

Regularizing a polygon - Making it geometrically valid.

```
dim resPolyIDArray[]
nPgon = CALLFUNCTION (ch, "Regularize", "poly1", resPolyIDArray)
```

A polygon is valid if

- Its first boundary contains all the others
- Is oriented correctly (the main contour is a positively oriented curve, the rest is oriented negatively)
- Has no self-intersections
- Its area is not zero
- Has no zero length edges

PolyCut

Intersecting the polygon with a halfplane.

The halfplane must be set with a *"HalfPlaneParams"* command. The result will be regularized.

```
dim resPolyIDArray[]
nPgon = CALLFUNCTION (ch, "PolyCut", "poly1", resPolyIDArray)
```

OffsetEdge

Translating an edge of a polygon perpendicularly to its direction.

The edge index and translation offset must be set with an *"OffsetParams"* command. The result will be regularized.

```
dim resPolyIDArray[]
nPgon = CALLFUNCTION (ch, "OffsetEdge", "poly1", resPolyIDArray)
```

OffsetMultipleEdges

Translating multiple edges of a polygon perpendicularly to its direction.

The edge indices and translation offsets must be set with an *"MultipleEdgeOffsetParams"* command. The result will be regularized.

```
dim resPolyIDArray[]
nPgon = CALLFUNCTION (ch, "OffsetMultipleEdges", "poly1", resPolyIDArray)
```

OffsetPolyline

Translating all edges of a polyline perpendicularly

The translation offset must be set with an *"OffsetParams"* command.

```
dim resPolyIDArray[]
nPline = CALLFUNCTION (ch, "OffsetPolyline", "polyline1", resPolyIDArray)
```

OffsetPolylineWithVectors

Translating all edges of an open polyline perpendicularly, and moving the endpoints along a vector

The translation vectors and offset must be set with "*PolylineOffsetVectors*" and "*OffsetParams*" commands.

```
dim resPolyIDArray[]
nPline = CALLFUNCTION (ch, "OffsetPolylineWithVectors", "polyline1", resPolyIDArray)
Gives Input argument error for closed polylines
```

ResizeContour

Enlarges or shrinks a contour of a polygon.

The contour index and translation offset must be set with an "*OffsetParams*" command. The result will be regularized.

```
dim resPolyIDArray[]
nPgon = CALLFUNCTION (ch, "ResizeContour", "poly1", resPolyIDArray)
```

CentreOfGravity

Computes the centre of gravity of a polygon. *Compatibility: introduced in ARCHICAD 22.*

```
n = CALLFUNCTION (ch, "CentreOfGravity", "poly1", x, y)
```

Returned values:

n: 1 on success, 0 if the centre of gravity is not well-defined, eg. the polygon was self-intersecting.

x, y: The coordinates of the centre of gravity.

Get resulting polygons / polylines

Array

GetSourcePolygons, GetSourcePolylines

Getting all polygon / polyline names from the actual source container.

```
dim resPolyIDArray[], resPolylineIDArray[]
nPgon = CALLFUNCTION (ch, "GetSourcePolygons", "", resPolyIDArray)
nPline = CALLFUNCTION (ch, "GetSourcePolylines", "", resPolylineIDArray)
```

GetDestinationPolygons, GetDestinationPolylines

Getting all polygon / polyline names from the actual destination container.

```
dim resPolyIDArray[], resPolylineIDArray[]
nPgon = CALLFUNCTION (ch, "GetDestinationPolygons", "", resPolyIDArray)
nPline = CALLFUNCTION (ch, "GetDestinationPolylines", "", resPolylineIDArray)
```

GetVertices, GetPolylineVertices

Getting the resulting polygon / polyline vertices after any polygon / polyline operation call.

The polygon / polyline with name "polygonID" or "polylineID" is located in the destination container.

```
dim resVertices[], resPolylineVertices[]
nVertices = CALLFUNCTION (ch, "GetVertices", polygonID, resVertices)
nVertices = CALLFUNCTION (ch, "GetPolylineVertices", polylineID, resPolylineVertices)
```

GetContourEnds

Getting the resulting polygon contour end indices after any polygon operation call.

The polygon with name "polygonID" is located in the destination container.

```
dim contArr[]
nContours = CALLFUNCTION (ch, "GetContourEnds", polygonID, contArr)
```

GetInhEdgeInfos, GetPolylineInhEdgeInfos

Getting the resulting polygon contour / polyline information after any polygon / polyline operation call.

```
dim inhEdgeInfosArr[], polylineInhEdgeInfosArr[]
nEdgeInfos = CALLFUNCTION (ch, "GetInhEdgeInfos", polygonID, inhEdgeInfosArr)
nEdgeInfos = CALLFUNCTION (ch, "GetPolylineInhEdgeInfos",
    polylineID, polylineInhEdgeInfosArr)
```

The polygon / polyline with name "polygonID" or "polylineID" is located in the destination container.

Dictionary

GetSourceDictPolygon, GetSourceDictPolyline

Getting the source polygon / polyline as a dictionary. *Compatibility: introduced in ARCHICAD 23.*

The polygon / polyline with name "polygonID" or "polylineID" is located in the source container.

```
dict PolyOperationsPolygon, PolyOperationsPolyline
CALLFUNCTION (ch, "GetSourceDictPolygon", polygonID, PolyOperationsPolygon)
CALLFUNCTION (ch, "GetSourceDictPolyline", polylineID, PolyOperationsPolyline)
```

GetDestinationDictPolygon, GetDestinationDictPolyline

Getting the resulting polygon / polyline as a dictionary after any polygon / polyline operation call. *Compatibility: introduced in ARCHICAD 23.*

The polygon / polyline with name "polygonID" or "polylineID" is located in the destination container.

```
dict PolyOperationsPolygon, PolyOperationsPolyline
CALLFUNCTION (ch, "GetDestinationDictPolygon", polygonID, PolyOperationsPolygon)
CALLFUNCTION (ch, "GetDestinationDictPolyline", polylineID, PolyOperationsPolyline
```

Closing channel

Closes channel "ch". Deletes all of the stored polygons / polylines.

```
CLOSEADDDONSCOPE (ch)
```

AUTOTEXT GUIDE

It's not part of GDL itself. ARCHICAD will substitute all references to autotext fields in whatever GDL output it finds them. For example, if you write <PROJECTSTATUS> in the parameter string of a text2 command, ARCHICAD will nicely replace it with the actual value. All this is invisible to GDL – consequently the size and other attributes of the text are not measurable.

Project info keywords

```
PROJECTNAME
PROJECTNUMBER
PROJECTSTATUS
DATEOFISSUE
SITEFULLADDRESS
```

```
SITEADDRESS1
SITEADDRESS2
SITEADDRESS3
SITECITY
SITESTATE
```

```
SITEPOSTCODE
SITECOUNTRY
KEYWORDS
NOTES
ARCHITECTNAME
```

ARCHITECTPOSITION
CADTECHNICIAN
ARCHITECTCOMPANY
ARCHITECTFULLADDRESS
ARCHITECTADDRESS1

ARCHITECTADDRESS2
ARCHITECTADDRESS3
ARCHITECTCITY
ARCHITECTSTATE
ARCHITECTPOSTCODE

ARCHITECTCOUNTRY
ARCHITECTEMAIL
ARCHITECTPHONE
ARCHITECTFAX
ARCHITECTWEB

CLIENTNAME
CLIENTCOMPANY
CLIENTFULLADDRESS
CLIENTADDRESS1
CLIENTADDRESS2

CLIENTADDRESS3
CLIENTCITY
CLIENTSTATE
CLIENTPOSTCODE
CLIENTCOUNTRY

CLIENTEMAIL
CLIENTPHONE
CLIENTFAX

General

SHORTDATE

LONGDATE
TIME
FILENAME
FILEPATH
LASTSAVEDAT
LASTSAVEDBY

Layout autotexts

LAYOUTNAME
LAYOUTID
SUBSETNAME
SUBSETID
LAYOUTNUMBER
NUMOFLAYOUTS

Drawing autotexts

DRAWINGNAME
DRAWINGID
DRAWINGSCALE
ORIGINALSCALE
MAGNIFICATION
RENOVATIONFILTER

Reference type autotexts

LAYOUTNAME_R
LAYOUTID_R
SUBSETNAME_R
SUBSETID_R
DRAWINGNAME_R
DRAWINGID_R
DRAWINGSCALE_R
ORIGINALSCALE_R

MAGNIFICATION_R
FILENAME_R
FILEPATH_R
LAYOUTNUMBER_R
RENOVATIONFILTER_R

Marker type autotexts

MARKERSHEETNUMBER_R
MARKERDRAWINGNUMBER_R
MARKERSHEETNUMBER90_R
MARKERDRAWINGNUMBER90_R
MARKERSHEETNUMBER110_R
MARKERDRAWINGNUMBER110_R
BACKREFSHEETNUMBER_R

Change related autotexts

CHANGEID
CHANGEDescription
REVISIONID
ISSUEID
ISSUEDESCRIPTION
ISSUEDATE
ISSUEBY

Layout revision related autotexts

CURRENTREVISIONID
CURRENTISSUEID
CURRENTISSUEDESCRIPTION
CURRENTISSUEDATE
CURRENTISSUEBY

NEW GDL FEATURES IN ARCHICAD 23

This section contains a fly-through of the new GDL features in ARCHICAD 23. For more details, tutorials and examples, visit [GDL Center](https://gdl.graphisoft.com) [https://gdl.graphisoft.com].

New data type: dictionary

It is now possible to organize variables and parameters in a structured way, similar to many other languages. Dictionary data type – declared with the keyword `DICT` – is a hierarchical collection of key-value pairs, where values can be other dictionaries or arrays too.

```
dict pointA, object
pointA.x = 1
pointA.y = 2
object.parts[3].edges[4].points[5] = pointA
```

This technique

- allows more readable and easier-to-maintain code
- can be used when more-than-two dimensional arrays would be needed
- reduces the number of variables needed for data exchange between ARCHICAD and GDL objects (global variables and requests)
- reduces the number of parameters needed for data exchange between objects and macros

For more detailed info, see

- general syntax: *Structured Types*, `DICT`
- new functions: `HASKEY`, `REMOVEKEY`, *PolyOperations* functions
- new return type: `VARTYPE`
- globals using dict data type: `OPENING_SYMBOL_GEOMETRY`, `OPENING_HEADERHEIGHT_VALUES`, `OPENING_CENTERHEIGHT_VALUES`, `OPENING_SILLHEIGHT_VALUES`, `BEAM_SEGMENT_INFO`, `COLU_SEGMENT_INFO`
- requests using dict data type: "Component_Ids_Of_Parent", "Component_Property_Values_Of_Parent", "Property_Values_Of_Parent" requests

New functions in PolyOperations add-on

Polygons/polylines can be given as a dictionary when communicating with the *PolyOperations* add-on. The general workflow is the same, storing/reading can be simplified with these functions:

- *StoreDictPolyline*, *StoreDictPolygon*

- *GetSourceDictPolyline, GetSourceDictPolygon*
- *GetDestinationDictPolyline, GetDestinationDictPolygon*

The dictionary structure is the same as `OPENING_SYMBOL_GEOMETRY.polygon2D`. For more detailed info, see the Polygon Operations Extension – Polygon / polyline management – the section called “Dictionary”.

New tool: Opening

The new opening tool’s 2D symbol is a GDL object. New symbols can be created using the subtype `General GDL Object / Documentation Element / Opening Symbol`. An opening has two independent symbols, one shown when the opening is cut (in a wall), the other when the opening is viewed (in a slab).

For more detailed info, see

- `OPENING_SYMBOL_DISPLAY`
- `OPENING_SYMBOL_GEOMETRY`
- `OPENING_HEIGHT`
- `OPENING_WIDTH`
- `OPENING_HEADERHEIGHT_VALUES`
- `OPENING_CENTERHEIGHT_VALUES`
- `OPENING_SILLHEIGHT_VALUES`
- `GLOB_ELEM_TYPE`

Updated tools: Beam and Column

With the updated Beam and Column tools it is possible to model multi-segmented elements. New labels can be chosen to be placed on the elements or on segments, labels placed on segments receive a new `GLOB_ELEM_TYPE`. Most of the Beam and Column global variables are available for them, for availability details see *Beam* and *Column* global variables sections.

For more detailed info, see

- `GLOB_ELEM_TYPE`
- `BEAM_SEGMENT_INDEX`
- `COLU_SEGMENT_INDEX`
- `BEAM_SEGMENT_INFO`
- `COLU_SEGMENT_INFO`
- deprecated `BEAM_CROSSSECTION_TYPE`
- deprecated `COLU_CROSSSECTION_TYPE`

- deprecated `ac_beam_crosssection_type`
- deprecated `ac_colu_crosssection_type`

New Property requests

From ARCHICAD 23 Building Materials can have Properties and Classifications. The properties of the building materials are referred to as component properties, as these properties belong to a component of the parent element. To display these properties new REQUESTs have been introduced, which are available in Labels.

The input and output values of “Component_Ids_Of_Parent” and “Component_Property_Values_Of_Parent” requests are in the new dictionary format, “Component_Properties_Of_Parent” has the same input and output data structure as the existing “Properties_Of_Parent” request.

- “Component_Ids_Of_Parent”:

The available Building Material components in the parent element are identified by ARCHICAD, these IDs are available through the “Component_Ids_Of_Parent” request.

- “Component_Property_Values_Of_Parent”:

To get the component property values of a parent element, the new “Component_Property_Values_Of_Parent” request can be used. It returns the property values for a given component with any number of given property IDs.

- “Component_Properties_Of_Parent”:

For the Property selection on the User Interface the “Component_Properties_Of_Parent” has been introduced. This request is similar to “Properties_Of_Parent”, except that it returns the available component properties of the parent element.

- “Property_Values_Of_Parent”:

A new request version of the “Property_Value_Of_Parent” request is available: “Property_Values_Of_Parent”. This request’s input and output values are defined in the new dictionary format. Unlike “Property_Value_Of_Parent”, multiple property IDs can be defined as dictionary keys, and multiple property values are returned.

Diagnostics mode

There is a new menu command that allows easier debugging where the GDL Debugger doesn’t work (complex tools like Curtain Wall, Stair, Railing, Opening or debugging the contents of dictionaries). In the Library Developer Menu (it can be added via Work Environment / Menus) the Library Part Diagnostics Mode menu item toggles the `GLOB_DIAGNOSTICS_MODE` global. It can be used to write conditional PRINT commands and/or show hidden parameters on the UI that control the debugging process. The model is not automatically rebuilt after toggling the menu, use Rebuild & Regenerate (Ctrl-Alt-Shift-R) to re-run the scripts.

Some ARCHICAD library parts use this feature, make sure to publish plans with the menu item turned off.

Command updates and extended versions

- TUBE and TUBE { 2 }:
Edge elimination (automatically hidden lines where two faces meet in the same plane with the same surface) is possible with these commands too. Similarly to CPRISM_ { 3 }, masks can be given for the whole body to control base, end, longitudinal and sectional edges.
- new COONS { 2 }:
It is possible to hide the boundaries of a COONS with a smooth surface.
- new RULEDSEGMENTED { 2 }:
It is possible to assign different materials to each segment and control the texture projection.
- “ASSOCLP_PARVALUE” request:
“ASSOCLP_PARVALUE” and “ASSOCLP_PARVALUE_WITH_DESCRIPTION” requests can handle parameters of profile type.
- Documentation:
We made some clarifications in the Reference Guide, it is recommended to look them up in case of using these:
 - AC_LabelPointerLineType - type
 - AC_LabelPointerPen - type
 - AC_bLabelFrame - type
 - ac_holeSideMaterial – previously existing, but undocumented
 - ac_holeMaterialCurved – previously existing, but undocumented
 - ac_beam_cut_linetype – previously existing, but undocumented
 - ac_beam_overhead_linetype – previously documented, but non-existing
 - VARTYPE – undocumented return value 3 for groups, new value 4 for dictionaries
 - "CentreOfGravity" – previously existing, but undocumented PolyOperations function

IFC4

The IFC Add-on uses IFC4 standard instead of IFC 2×3. There are some minor changes in these these fix-named parameters:

- ifc_optype - new opening type for Doors
- ifc_optype, ifc_CapacityByWeight and ifc_CapacityByNumber - deprecated for Transport Elements
- ifc_subtype - new types for MEP elements

Details are listed in the the section called “Parameters of IFC add-on”.

New source format with LP_XMLConverter

The LP_XMLConverter tool can convert to and from a new type of source format called HSF. Library parts are stored in the same folder as images, the xml source is split into smaller xml files and separate .gdl scripts.

LCF and GSM made from XML is fully compatible in ARCHICAD with one made from HSF, conversion between HSF and XML can be done using LP_XMLConverter via the GSM format.

For more information about the LP_XMLConverter tool, check out the [GDL Center Tips and Tricks](https://gdl.graphisoft.com/tips-and-tricks/how-to-use-the-lp_xmlconverter-tool) [https://gdl.graphisoft.com/tips-and-tricks/how-to-use-the-lp_xmlconverter-tool]

INDEX

SYNTAX LISTING OF GDL COMMANDS

A

```
ABS (x)
ACS (x)
ADD dx, dy, dz
ADD2 x, y
ADDGROUP (g_expr1, g_expr2)
ADDGROUP{2} (g_expr1, g_expr2, edgeColor, materialId, materialColor [, operationStatus])
ADDGROUP{3} (g_expr1, g_expr2, edgeColor, materialId, materialColor [, operationStatus])
LIGHT red, green, blue, shadow,
    radius, alpha, beta, angle_falloff,
    distance1, distance2,
    distance_falloff [[,] ADDITIONAL_DATA name1 = value1,
    name2 = value2, ...]
DEFINE MATERIAL name [,] BASED_ON orig_name [,] PARAMETERS name1 = expr1 [, ...]
    [[,] ADDITIONAL_DATA name1 = expr1 [, ...]]
ADDX dx
ADDY dy
ADDZ dz
LOCK ALL ["name1" [, "name2", ..., "namen"]]
HIDEPARAMETER ALL ["name1" [, "name2", ..., "namen"]]
```

```
CALL macro_name_string [,]
    PARAMETERS [ALL][name1=value1, ..., namen=valuen][[,]
    RETURNED_PARAMETERS r1, r2, ...]

APPLICATION_QUERY (extension_name, parameter_string, variable1, variable2, ...)

ARC r, alpha, beta

ARC2 x, y, r, alpha, beta

ARMC r1, r2, l, h, d, alpha

ARME l, r1, r2, h, d

ASN (x)

ATN (x)
```

B

```
BASE

DEFINE MATERIAL name [,] BASED_ON orig_name [,] PARAMETERS name1 = expr1 [, ...]
    [[,] ADDITIONAL_DATA name1 = expr1 [, ...]]

BEAM left_material, right_material, vertical_material,
    top_material, bottom_material,
    height,
    x1, x2, x3, x4,
    y1, y2, y3, y4, t,
    mask1, mask2, mask3, mask4

BINARY mode [, section, elementID]

BINARYPROP

BITSET (x, b [, expr])

BITTEST (x, b)

BLOCK a, b, c
```

BODY status

BPRISM_ top_material, bottom_material, side_material,
 n, h, radius,
 x1, y1, s1,
 ...
 xn, yn, sn

BREAKPOINT expression

BRICK a, b, c

[SET] BUILDING_MATERIAL name_or_index
 [, cut_fill_pen [, cut_fill_bkgd_pen, [iOverrideFlag]]]

IND (BUILDING_MATERIAL, name_string)

BWALL_ left_material, right_material, side_material,
 height, x1, x2, x3, x4, t, radius,
 mask1, mask2, mask3, mask4,
 n,
 x_start1, y_low1, x_end1, y_high1, frame_shown1,
 ...
 x_startn, y_lown, x_endn, y_highn, frame_shownn,
 m,
 a1, b1, c1, d1,
 ...
 am, bm, cm, dm

C

CALL macro_name_string [,]
 PARAMETERS [ALL][name1=value1, ..., namen=valuen][[,]
 RETURNED_PARAMETERS r1, r2, ...]

CALL macro_name_string [,]PARAMETERS
 value1 or DEFAULT [, ..., valuen or DEFAULT]

```
CALL macro_name_string [, parameter_list]
CALLFUNCTION (channel, function_name, parameter, variable1 [, variable2, ...])
CEIL (x)
CIRCLE r
CIRCLE2 x, y, r
CLOSE channel
CLOSEADDONSCOPE channel
COMPONENT name, quantity, unit [, proportional_with, code, keycode, unitcode]
CONE h, r1, r2, alpha1, alpha2
COONS n, m, mask,
    x11, y11, z11, ..., x1n, y1n, z1n,
    x21, y21, z21, ..., x2n, y2n, z2n,
    x31, y31, z31, ..., x3m, y3m, z3m,
    x41, y41, z41, ..., x4m, y4m, z4m
COONS{2} n, m, mask,
    x11, y11, z11, ..., x1n, y1n, z1n,
    x21, y21, z21, ..., x2n, y2n, z2n,
    x31, y31, z31, ..., x3m, y3m, z3m,
    x41, y41, z41, ..., x4m, y4m, z4m
COOR wrap, vert1, vert2, vert3, vert4
COOR{2} wrap_method, wrap_flags, vert1, vert2, vert3, vert4
COOR{3} wrapping_method, wrap_flags,
    origin_X, origin_Y, origin_Z,
    endOfX_X, endOfX_Y, endOfX_Z,
    endOfY_X, endOfY_Y, endOfY_Z,
    endOfZ_X, endOfZ_Y, endOfZ_Z
```

COS (x)

CPRISM_ top_material, bottom_material, side_material,
n, h,
x1, y1, s1, ..., xn, yn, sn

CPRISM_{2} top_material, bottom_material, side_material,
n, h,
x1, y1, alpha1, s1, mat1,
...
xn, yn, alphan, sn, matn

CPRISM_{3} top_material, bottom_material, side_material, mask,
n, h,
x1, y1, alpha1, s1, mat1,
...
xn, yn, alphan, sn, matn

CPRISM_{4} top_material, bottom_material, side_material, mask,
n, h,
x1, y1, alpha1, s1, mat1,
...
xn, yn, alphan, sn, matn

CREATEGROUPWITHMATERIAL (g_expr, repl_directive, pen, material)

CROOF_ top_material, bottom_material, side_material,
n, xb, yb, xe, ye, height, angle, thickness,
x1, y1, alpha1, s1,
...
xn, yn, alphan, sn

CROOF_{2} top_material, bottom_material, side_material,
n, xb, yb, xe, ye, height, angle, thickness,
x1, y1, alpha1, s1, mat1,
...
xn, yn, alphan, sn, matn

```

CROOF_{3} top_material, bottom_material, side_material, mask,
          n, xb, yb, xe, ye, height, angle, thickness,
          x1, y1, alpha1, s1, mat1,
          ...
          xn, yn, alphan, sn, matn

CROOF_{4} top_material, bottom_material, side_material, mask,
          n, xb, yb, xe, ye, height, angle, thickness,
          x1, y1, alpha1, s1, mat1,
          ...
          xn, yn, alphan, sn, matn

CSLAB_ top_material, bottom_material, side_material,
        n, h,
        x1, y1, z1, s1, ..., xn, yn, zn, sn

CUTPLANE [x [, y [, z [, side [, status]]]]]
[statement1 ... statementn]
CUTEND

CUTPLANE{2} angle [, status]
[statement1 ... statementn]
CUTEND

CUTPLANE{3} [x [, y [, z [, side [, status]]]]]
[statement1 ... statementn]
CUTEND

CUTPOLY n,
        x1, y1, ..., xn, yn
        [, x, y, z]
[statement1
statement2
...
statementn]
CUTEND

```

```
CUTPOLYA n, status, d,  
    x1, y1, mask1, ..., xn, yn, maskn [,  
    x, y, z]  
[statement1  
statement2  
...  
statementn]  
CUTEND  
  
CUTSHAPE d [, status]  
[statement1 statement2 ... statementn]  
CUTEND  
  
CUTFORM n, method, status,  
    rx, ry, rz, d,  
    x1, y1, mask1 [, mat1],  
    ...  
    xn, yn, maskn [, matn]  
  
CUTFORM{2} n, method, status,  
    rx, ry, rz, d,  
    x1, y1, mask1 [, mat1],  
    ...  
    xn, yn, maskn [, matn]  
  
CUTPLANE [x [, y [, z [, side [, status]]]]]  
[statement1 ... statementn]  
CUTEND  
  
CUTPLANE{2} angle [, status]  
[statement1 ... statementn]  
CUTEND  
  
CUTPLANE{3} [x [, y [, z [, side [, status]]]]]  
[statement1 ... statementn]  
CUTEND
```

```
CUTPOLY n,  
    x1, y1, ..., xn, yn  
    [, x, y, z]  
[statement1  
statement2  
...  
statementn]  
CUTEND  
  
CUTPOLYA n, status, d,  
    x1, y1, mask1, ..., xn, yn, maskn [,  
    x, y, z]  
[statement1  
statement2  
...  
statementn]  
CUTEND  
  
CUTSHAPE d [, status]  
[statement1 statement2 ... statementn]  
CUTEND  
  
CWALL_ left_material, right_material, side_material,  
    height, x1, x2, x3, x4, t,  
    mask1, mask2, mask3, mask4,  
    n,  
    x_start1, y_low1, x_end1, y_high1, frame_shown1,  
    ...  
    x_startn, y_lown, x_endn, y_highn, frame_shownn,  
    m,  
    a1, b1, c1, d1,  
    ...  
    am, bm, cm, dm  
  
CYLIND h, r
```

D

```
DATABASE_SET set_name [, descriptor_name, component_name, unit_name, key_name,
    criteria_name, list_set_name]

CALL macro_name_string [,]PARAMETERS
    value1 or DEFAULT [, ..., valuen or DEFAULT]

CALL macro_name_string [,]PARAMETERS
    value1 or DEFAULT [, ..., valuen or DEFAULT]

DEFINE EMPTY_FILL name [[,] FILLTYPES_MASK fill_types]

DEFINE FILL name [[,] FILLTYPES_MASK fill_types,]
    pattern1, pattern2, pattern3, pattern4,
    pattern5, pattern6, pattern7, pattern8,
    spacing, angle, n,
    frequency1, direction1, offset_x1, offset_y1, m1,
    length11, ..., length1m,
    ...
    frequencyn, directionn, offset_xn,
    lengthn1, ..., lengthnm

DEFINE FILLA name [,] [FILLTYPES_MASK fill_types,]
    pattern1, pattern2, pattern3, pattern4,
    pattern5, pattern6, pattern7, pattern8,
    spacing_x, spacing_y, angle, n,
    frequency1, directional_offset1, direction1,
    offset_x1, offset_y1, m1,
    length11, ..., length1m,
    ...
    frequencyn, directional_offsetn, directionn,
    offset_xn, offset_yn, mn,
    lengthn1, ..., lengthnm
```

```

DEFINE IMAGE_FILL name image_name [[,] FILLTYPES_MASK fill_types]
    part1, part2, part3, part4, part5, part6, part7, part8,
    image_vert_size, image_hor_size, image_mask, image_rotangle
DEFINE LINEAR_GRADIENT_FILL name [[,] FILLTYPES_MASK fill_types]
DEFINE LINE_TYPE name spacing, n,
    length1, ..., lengthn
DEFINE MATERIAL name type,
    surface_red, surface_green, surface_blue
    [, ambient_ce, diffuse_ce, specular_ce, transparent_ce,
    shining, transparency_attenuation
    [, specular_red, specular_green, specular_blue,
    emission_red, emission_green, emission_blue, emission_att]]
    [, fill_index [, fillcolor_index, texture_index]]
DEFINE MATERIAL name [,] BASED_ON orig_name [,] PARAMETERS name1 = expr1 [, ...]
    [[,] ADDITIONAL_DATA name1 = expr1 [, ...]]
DEFINE RADIAL_GRADIENT_FILL name [[,] FILLTYPES_MASK fill_types]
DEFINE SOLID_FILL name [[,] FILLTYPES_MASK fill_types]
DEFINE STYLE name font_family, size, anchor, face_code
DEFINE STYLE{2} name font_family, size, face_code
DEFINE SYMBOL_FILL name [,][FILLTYPES_MASK fill_types,]
    pat1, pat2, pat3, pat4, pat5, pat6, pat7, pat8,
    spacingx1, spacingy1, spacingx2, spacingy2,
    angle, scaling1, scaling2, macro_name [,] PARAMETERS [name1
    = value1, ..., namen = valuen]
DEFINE SYMBOL_LINE name dash, gap, macro_name PARAMETERS [name1 = value1,
    ...
    namen = valuen]
DEFINE TEXTURE name expression, x, y, mask, angle

```

```
DEFINE TRANSLUCENT_FILL name [[,] FILLTYPES_MASK fill_types]
    pat1, pat2, pat3, pat4, pat5, pat6, pat7, pat8,
    percentage

DEL n [, begin_with]

DEL TOP

DELETED_PAR_VALUE ("oldparname", outputvalue)

DESCRIPTOR name [, code, keycode]

DICT variableName1[, variableName2...]

DIM var1[dim_1], var2[dim_1][dim_2], var3[ ],
    var4[ ][ ], var5[dim_1][ ],
    var5[ ][dim_2]

DO [statement1
    statement2
    ...
    statementn]

WHILE condition

WHILE condition DO
    [statement1
    statement2
    ...
    statementn]

ENDWHILE

DRAWINDEX number

DRAWING

DRAWING2 [expression]

DRAWING3 projection_code, angle, method

DRAWING3{2} projection_code, angle, method [, backgroundColor,
```

```
    fillOrigoX, fillOrigoY, filldirection]
DRAWING3{3} projection_code, angle, method, parts [, backgroundColor,
    fillOrigoX, fillOrigoY, filldirection][[,]
PARAMETERS name1=value1, ..., namen=valuen]
```

E

```
EDGE vert1, vert2, pgon1, pgon2, status
ELBOW r1, alpha, r2
ELLIPS h, r
IF condition THEN statement [ELSE statement]
IF condition THEN
    [statement1
    statement2
    ...
    statementn]
[ELSE
    statementn+1
    statementn+2
    ...
    statementn+m]
ENDIF
END [v1, v2, ..., vn]
GROUP "name"
    [statement1 ... statementn]
ENDGROUP
IF condition THEN
    [statement1
    statement2
    ...
```

```
    statementn]
[ELSE
    statementn+1
    statementn+2
    ...
    statementn+m]
ENDIF

PARAGRAPH name alignment, firstline_indent,
           left_indent, right_indent, line_spacing [,
           tab_position1, ...]
[PEN index]
[[SET] STYLE style1]
[[SET] MATERIAL index]
'string1'
'string2'
...
'string n'
[PEN index]
[[SET] STYLE style2]
[[SET] MATERIAL index]
'string1'
'string2'
...
'string n'
...
ENDPARAGRAPH

WHILE condition DO
    [statement1
    statement2
    ...
    statementn]
ENDWHILE
```

EXIT [v1, v2, ..., vn]

EXP (x)

EXTRUDE n, dx, dy, dz, mask,
x1, y1, s1,
...
xn, yn, sn

EXTRUDESHELL topMat, bottomMat, sideMat_1, sideMat_2, sideMat_3, sideMat_4,
defaultMat,
n, offset, thickness, flipped, trimmingBody,
x_tb, y_tb, x_te, y_te, topz, tangle,
x_bb, y_bb, x_be, y_be, bottomz, bangle,
preThickenTran_11, preThickenTran_12, preThickenTran_13, preThickenTran_14,
preThickenTran_21, preThickenTran_22, preThickenTran_23, preThickenTran_24,
preThickenTran_31, preThickenTran_32, preThickenTran_33, preThickenTran_34,
x_1, y_1, s_1,
...
x_n, y_n, s_n

EXTRUDESHELL{2} topMat, bottomMat, sideMat_1, sideMat_2, sideMat_3, sideMat_4,
defaultMat,
n, status, offset, thickness, flipped, trimmingBody,
x_tb, y_tb, x_te, y_te, topz, tangle,
x_bb, y_bb, x_be, y_be, bottomz, bangle,
preThickenTran_11, preThickenTran_12, preThickenTran_13, preThickenTran_14,
preThickenTran_21, preThickenTran_22, preThickenTran_23, preThickenTran_24,
preThickenTran_31, preThickenTran_32, preThickenTran_33, preThickenTran_34,
x_1, y_1, s_1,
...
x_n, y_n, s_n

EXTRUDESHELL{3} topMat, bottomMat, sideMat_1, sideMat_2, sideMat_3, sideMat_4,
defaultMat,

```

n, status, offset, thickness, flipped, trimmingBody,
x_tb, y_tb, x_te, y_te, topz, tangle,
x_bb, y_bb, x_be, y_be, bottomz, bangle,
preThickenTran_11, preThickenTran_12, preThickenTran_13, preThickenTran_14,
preThickenTran_21, preThickenTran_22, preThickenTran_23, preThickenTran_24,
preThicakenTran_31, preThickenTran_32, preThickenTran_33, preThickenTran_34,
x_1, y_1, s_1,
...
x_n, y_n, s_n

```

F

```

FILE_DEPENDENCE "name1" [, "name2", ...]
[SET] FILL name_string
[SET] FILL index
IND (FILL, name_string)
DEFINE FILL name [[,] FILLTYPES_MASK fill_types,]
    pattern1, pattern2, pattern3, pattern4,
    pattern5, pattern6, pattern7, pattern8,
    spacing, angle, n,
    frequency1, direction1, offset_x1, offset_y1, m1,
    length11, ..., length1m,
    ...
    frequencyn, directionn, offset_xn,
    lengthn1, ..., lengthnm
DEFINE FILLA name [,] [FILLTYPES_MASK fill_types,]
    pattern1, pattern2, pattern3, pattern4,
    pattern5, pattern6, pattern7, pattern8,
    spacing_x, spacing_y, angle, n,
    frequency1, directional_offset1, direction1,
    offset_x1, offset_y1, m1,

```

```

    length11, ..., length1m,
    ...
    frequencyn, directional_offsetn, directionn,
    offset_xn, offset_yn, mn,
    lengthn1, ..., lengthnm

DEFINE SYMBOL_FILL name [,][FILLTYPES_MASK fill_types,]
    pat1, pat2, pat3, pat4, pat5, pat6, pat7, pat8,
    spacingx1, spacingy1, spacingx2, spacingy2,
    angle, scaling1, scaling2, macro_name [,] PARAMETERS [name1
    = value1, ..., namen = valuen]

DEFINE SOLID_FILL name [[,] FILLTYPES_MASK fill_types]
DEFINE EMPTY_FILL name [[,] FILLTYPES_MASK fill_types]
DEFINE LINEAR_GRADIENT_FILL name [[,] FILLTYPES_MASK fill_types]
DEFINE RADIAL_GRADIENT_FILL name [[,] FILLTYPES_MASK fill_types]
DEFINE TRANSLUCENT_FILL name [[,] FILLTYPES_MASK fill_types]
    pat1, pat2, pat3, pat4, pat5, pat6, pat7, pat8,
    percentage

DEFINE IMAGE_FILL name image_name [[,] FILLTYPES_MASK fill_types]
    part1, part2, part3, part4, part5, part6, part7, part8,
    image_vert_size, image_hor_size, image_mask, image_rotangle

VALUES "fill_parameter_name" [[,] FILLTYPES_MASK fill_types], value_definition1
    [, value_definition2, ...]

FOR variable_name = initial_value TO end_value [ STEP step_value ] NEXT variable_name

FPRISM_ top_material, bottom_material, side_material, hill_material,
    n, thickness, angle, hill_height,
    x1, y1, s1,
    ...
    xn, yn, sn

```

FRA (x)

FRAGMENT2 fragment_index, use_current_attributes_flag

FRAGMENT2 ALL, use_current_attributes_flag

G

GET (n)

IF condition THEN label

IF condition GOTO label

IF condition GOSUB label

GOSUB label

IF condition THEN label

IF condition GOTO label

IF condition GOSUB label

GOTO label

GROUP "name"

[statement1 ... statementn]

ENDGROUP

H

HASKEY (dictionary.key)

HIDEPARAMETER "name1" [, "name2", ..., "namen"]

HIDEPARAMETER ALL ["name1" [, "name2", ..., "namen"]]

HOTARC r, alpha, beta, unID

HOTARC2 x, y, r, startangle, endangle, unID

HOTLINE x1, y1, z1, x2, y2, z2, unID

HOTLINE2 x1, y1, x2, y2, unID

```

HOTSPOT x, y, z [, unID [, paramReference [, flags [, displayParam [, customDescription]]]]]
HOTSPOT2  x, y [, unID [, paramReference [, flags [, displayParam [,
"customDescription"]]]]]]
HPRISM_ top_mat, bottom_mat, side_mat,
        hill_mat,
        n, thickness, angle, hill_height, status,
        x1, y1, s1,
        ...
        xn, yn, sn

```

I

```

IF condition THEN label
IF condition GOTO label
IF condition GOSUB label

IF condition THEN label
IF condition GOTO label
IF condition GOSUB label

IF condition THEN label
IF condition GOTO label
IF condition GOSUB label

IF condition THEN statement [ELSE statement]

IF condition THEN
    [statement1
    statement2
    ...
    statementn]
[ELSE
    statementn+1
    statementn+2

```

```
    ...
    statementn+m]
ENDIF
IND (MATERIAL, name_string)
IND (BUILDING_MATERIAL, name_string)
IND (FILL, name_string)
IND (LINE_TYPE, name_string)
IND (STYLE, name_string)
IND (TEXTURE, name_string)
IND (PROFILE_ATTR, name_string, index)
INITADDONSCOPE (extension, parameter_string1, parameter_string2)
INPUT (channel, recordID, fieldID, variable1 [, variable2, ...])
INT (x)
ISECTGROUP (g_expr1, g_expr2)
ISECTGROUP{2} (g_expr1, g_expr2, edgeColor, materialId, materialColor [, operationStatus])
ISECTGROUP{3} (g_expr1, g_expr2, edgeColor, materialId, materialColor [, operationStatus])
ISECTLINES (g_expr1, g_expr2)
```

K

```
KILLGROUP g_expr
```

L

```
[LET] varnam = n
```

```
LGT (x)
```

```
LIBRARYGLOBAL (object_name, parameter, value)
```

```

LIGHT red, green, blue, shadow,
      radius, alpha, beta, angle_falloff,
      distance1, distance2,
      distance_falloff [[,] ADDITIONAL_DATA name1 = value1,
      name2 = value2, ...]

LINE2 x1, y1, x2, y2

LINE_PROPERTY expr

[SET] LINE_TYPE name_string

[SET] LINE_TYPE index

IND (LINE_TYPE, name_string)

LIN_ x1, y1, z1, x2, y2, z2

LOCK "name1" [, "name2", ..., "namen"]

LOCK ALL ["name1" [, "name2", ..., "namen"]]

LOG (x)

```

M

```

MASS top_material, bottom_material, side_material,
      n, m, mask, h,
      x1, y1, z1, s1,
      ...
      xn, yn, zn, sn,
      xn+1, yn+1, zn+1, sn+1,
      ...
      xn+m, yn+m, zn+m, sn+m

MASS{2} top_material, bottom_material, side_material,
      n, m, mask, h,
      x1, y1, z1, s1,
      ...

```

```
        xn, yn, zn, sn,  
        xn+1, yn+1, zn+1, sn+1,  
        ...  
        xn+m, yn+m, zn+m, sn+m  
[SET] MATERIAL name_or_index  
IND (MATERIAL, name_string)  
MAX (x1, x2, ..., xn)  
MESH a, b, m, n, mask,  
      z11, z12, ..., z1m,  
      z21, z22, ..., z2m,  
      ...  
      zn1, zn2, ..., znm  
MIN (x1, x2, ..., xn)  
MODEL WIRE  
MODEL SURFACE  
MODEL SOLID  
MUL mx, my, mz  
MUL2 x, y  
MULX mx  
MULY my  
MULZ mz
```

N

```
NEWPARAMETER "name", "type" [, dim1 [, dim2]]  
FOR variable_name = initial_value TO end_value [ STEP step_value ] NEXT variable_name  
NOT (x)
```

NSP

NTR ()

NURBSBODY shadowStatus, smoothnessMin, smoothnessMax

NURBSCURVE2D degree, nControlPoints,
knot_1, knot_2, ..., knot_m,
cPoint_1_x, cPoint_1_y, weight_1,
cPoint_2_x, cPoint_2_y, weight_2,
...,
cPoint_n_x, cPoint_n_y, weight_n

NURBSCURVE3D degree, nControlPoints,
knot_1, knot_2, ..., knot_m,
cPoint_1_x, cPoint_1_y, cPoint_1_z, weight_1,
cPoint_2_x, cPoint_2_y, cPoint_2_z, weight_2,
...,
cPoint_n_x, cPoint_n_y, cPoint_n_z, weight_n

NURBSEDGE vert1, vert2, curve, curveDomainBeg, curveDomainEnd, status, tolerance

NURBSFACE n, surface, tolerance,
trim1, trim2, ..., trimn

NURBSFACE{2} n, surface, tolerance,
wrap_method, wrap_flags,
x1, y1, z1,
x2, y2, z2,
x3, y3, z3,
x4, y4, z4,
trim1, trim2, ..., trimn

NURBSLUMP n, face1, face2, ..., facen

NURBSSURFACE degree_u, degree_v, nu, nv,
knot_u_1, knot_u_2, ..., knot_u_mu,
knot_v_1, knot_v_2, ..., knot_v_mv,

```

cPoint_1_1_x, cPoint_1_1_y, cPoint_1_1_z, weight_1_1,
cPoint_1_2_x, cPoint_1_2_y, cPoint_1_2_z, weight_1_2,
...,
cPoint_1_nv_x, cPoint_1_nv_y, cPoint_1_nv_z, weight_1_nv,
cPoint_2_1_x, cPoint_2_1_y, cPoint_2_1_z, weight_2_1,
...,
cPoint_nu_nv_x, cPoint_nu_nv_y, cPoint_nu_nv_z, weight_nu_nv
NURBSTRIM edge, curve, curveDomainBeg, curveDomainEnd, tolerance
NURBSTRIMSINGULAR vertex, curve, curveDomainBeg, curveDomainEnd, tolerance
NURBSVERT x, y, z, hard, tolerance

```

O

```

OPEN (filter, filename, parameter_string)
OUTPUT channel, recordID, fieldID, expression1 [, expression2, ...]

```

P

```

PARAGRAPH name alignment, firstline_indent,
           left_indent, right_indent, line_spacing [,
           tab_position1, ...]
[PEN index]
[[SET] STYLE style1]
[[SET] MATERIAL index]
'string1'
'string2'
...
'string n'
[PEN index]
[[SET] STYLE style2]
[[SET] MATERIAL index]
'string1'

```

```
'string2'
...
'string n'
...
ENDPARAGRAPH
PARAMETERS name1 = expression1 [,
    name2 = expression2, ...,
    namen = expressionn]
CALL macro_name_string [,]
    PARAMETERS [ALL][name1=value1, ..., namen=valuen][[,]
    RETURNED_PARAMETERS r1, r2, ...]
CALL macro_name_string [,]PARAMETERS
    value1 or DEFAULT [, ..., valuen or DEFAULT]

PARVALUE_DESCRIPTION (parname [, ind1 [, ind2]])
PEN n
PGON n, vect, status, edge1, edge2, ..., edgen
PGON{2} n, vect, status, wrap, edge_or_wrap1, ..., edge_or_wrapn
PGON{3} n, vect, status, wrap_method, wrap_flags, edge_or_wrap1, ..., edge_or_wrapn
PI
PICTURE expression, a, b, mask
PICTURE2 expression, a, b, mask
PICTURE2{2} expression, a, b, mask
PIPG expression, a, b, mask, n, vect, status,
    edge1, edge2, ..., edgen
PLACEGROUP g_expr
```

PLANE *n*, *x1*, *y1*, *z1*, ..., *xn*, *yn*, *zn*
PLANE_ *n*, *x1*, *y1*, *z1*, *s1*, ..., *xn*, *yn*, *zn*, *sn*
POINTCLOUD "data_file_name"
POLY *n*, *x1*, *y1*, ..., *xn*, *yn*
POLY2 *n*, frame_fill, *x1*, *y1*, ..., *xn*, *yn*
POLY2_ *n*, frame_fill, *x1*, *y1*, *s1*, ..., *xn*, *yn*, *sn*
POLY2_A *n*, frame_fill, fill_pen,
 x1, *y1*, *s1*, ..., *xn*, *yn*, *sn*
POLY2_B *n*, frame_fill,
 fill_pen, fill_background_pen,
 x1, *y1*, *s1*, ..., *xn*, *yn*, *sn*
POLY2_B{2} *n*, frame_fill,
 fill_pen, fill_background_pen,
 fillOrigoX, fillOrigoY, fillAngle,
 x1, *y1*, *s1*, ..., *xn*, *yn*, *sn*
POLY2_B{3} *n*, frame_fill,
 fill_pen, fill_background_pen,
 fillOrigoX, fillOrigoY,
 mxx, *mxy*, *myx*, *myy*, *x1*, *y1*, *s1*, ..., *xn*, *yn*, *sn*
POLY2_B{4} *n*, frame_fill,
 fill_pen, fill_background_pen,
 fillOrigoX, fillOrigoY,
 mxx, *mxy*, *myx*, *myy*,
 gradientInnerRadius,
 x1, *y1*, *s1*, ..., *xn*, *yn*, *sn*
POLY2_B{5} *n*, frame_fill, fillcategory, distortion_flags,
 fill_pen, fill_background_pen,
 fillOrigoX, fillOrigoY,

```

    mxx, mxy, myx, myy,
    gradientInnerRadius,
    x1, y1, s1, ..., xn, yn, sn
POLY2_B{6} n, frame_fill, fillcategory, distortion_flags,
    fill_pen, fill_background_pen,
    fillOrigoX, fillOrigoY,
    mxx, mxy, myx, myy,
    gradientInnerRadius,
    x1, y1, s1, pen1, linetype1, ..., xn, yn, sn, penn, linetypen
POLYROOF defaultMat, k, m, n,
    offset, thickness, applyContourInsidePivot,
    z_1, ..., z_k,
    pivotX_1, pivotY_1, pivotMask_1,
    roofAngle_1l, gableOverhang_1l, topMat_1l, bottomMat_1l,
    ...
    roofAngle_1k, gableOverhang_1k, topMat_1k, bottomMat_1k,
    ...
    pivotX_m, pivotY_m, pivotMask_m,
    roofAngle_m1, gableOverhang_m1, topMat_m1, bottomMat_m1,
    ...
    roofAngle_mk, gableOverhang_mk, topMat_mk, bottomMat_mk,
    contourX_1, contourY_1, contourMask_1, edgeTrim_1, edgeAngle_1, edgeMat_1,
    ...
    contourX_n, contourY_n, contourMask_n, edgeTrim_n, edgeAngle_n, edgeMat_n
POLYROOF{2} defaultMat, k, m, n,
    offset, thickness, totalThickness, applyContourInsidePivot,
    z_1, ..., z_k,
    pivotX_1, pivotY_1, pivotMask_1,
    roofAngle_1l, gableOverhang_1l, topMat_1l, bottomMat_1l,
    ...
    roofAngle_1k, gableOverhang_1k, topMat_1k, bottomMat_1k,

```

```

...
pivotX_m, pivotY_m, pivotMask_m,
roofAngle_m1, gableOverhang_m1, topMat_m1, bottomMat_m1,
...
roofAngle_mk, gableOverhang_mk, topMat_mk, bottomMat_mk,
contourX_1, contourY_1, contourMask_1, edgeTrim_1, edgeAngle_1, edgeMat_1,
...
contourX_n, contourY_n, contourMask_n, edgeTrim_n, edgeAngle_n, edgeMat_n
POLYROOF{3} defaultMat, mask, k, m, n,
  offset, thickness, totalThickness, applyContourInsidePivot,
  z_1, ..., z_k,
  pivotX_1, pivotY_1, pivotMask_1,
  roofAngle_11, gableOverhang_11, topMat_11, bottomMat_11,
  ...
  roofAngle_1k, gableOverhang_1k, topMat_1k, bottomMat_1k,
  ...
  pivotX_m, pivotY_m, pivotMask_m,
  roofAngle_m1, gableOverhang_m1, topMat_m1, bottomMat_m1,
  ...
  roofAngle_mk, gableOverhang_mk, topMat_mk, bottomMat_mk,
  contourX_1, contourY_1, contourMask_1, edgeTrim_1, edgeAngle_1, edgeMat_1,
  ...
  contourX_n, contourY_n, contourMask_n, edgeTrim_n, edgeAngle_n, edgeMat_n
POLYROOF{4} defaultMat, mask, k, m, n,
  offset, thickness, totalThickness, applyContourInsidePivot,
  z_1, ..., z_k,
  pivotX_1, pivotY_1, pivotMask_1,
  roofAngle_11, gableOverhang_11, topMat_11, bottomMat_11,
  ...
  roofAngle_1k, gableOverhang_1k, topMat_1k, bottomMat_1k,
  ...
  pivotX_m, pivotY_m, pivotMask_m,

```

```

    roofAngle_m1, gableOverhang_m1, topMat_m1, bottomMat_m1,
    ...
    roofAngle_mk, gableOverhang_mk, topMat_mk, bottomMat_mk,
    contourX_1, contourY_1, contourMask_1, edgeTrim_1, edgeAngle_1, edgeMat_1,
    ...
    contourX_n, contourY_n, contourMask_n, edgeTrim_n, edgeAngle_n, edgeMat_n
POLY_ n, x1, y1, s1, ..., xn, yn, sn
POSITION position_keyword
PREPAREFUNCTION channel, function_name, expression1 [, expression2, ...]
PRINT expression [, expression, ...]
PRISM n, h, x1, y1, ..., xn, yn
PRISM_ n, h, x1, y1, s1, ..., xn, yn, sn
VALUES "profile_parameter_name" [[,] PROFILETYPES_MASK profile_types], value_definition1
    [, value_definition2, ...]
IND (PROFILE_ATTR, name_string, index)
PROJECT2 projection_code, angle, method
PROJECT2{2} projection_code, angle, method [, backgroundColor,
    fillOrigoX, fillOrigoY, filldirection]
PROJECT2{3} projection_code, angle, method, parts [, backgroundColor,
    fillOrigoX, fillOrigoY, filldirection][[,]
    PARAMETERS name1=value1, ..., namen=valuen]
PROJECT2{4} projection_code, angle,
    useTransparency, statusParts,
    numCutplanes,
    cutplaneHeight1, ..., cutplaneHeightn,
    method1, parts1,
    cutFillIndex1,
    cutFillFgPen1, cutFillBgPen1,

```

```

cutFillOrigoX1, cutFillOrigoY1, cutFillDirection1,
cutLinePen1, cutLineType1,
projectedFillIndex1,
projectedFillFgPen1, projectedFillBgPen1,
projectedFillOrigoX1, projectedFillOrigoY1,
projectedFillDirection1,
projectedLinePen1, projectedLineType1,
...
method(numCutplanes+1), parts(numCutplanes+1),
cutFillIndex(numCutplanes+1),
cutFillFgPen(numCutplanes+1), cutFillBgPen(numCutplanes+1),
cutFillOrigoX(numCutplanes+1), cutFillOrigoY(numCutplanes+1),
cutFillDirection(numCutplanes+1),
cutLinePen(numCutplanes+1), cutLineType(numCutplanes+1),
projectedFillIndex(numCutplanes+1),
projectedFillFgPen(numCutplanes+1), projectedFillBgPen(numCutplanes+1),
projectedFillOrigoX(numCutplanes+1), projectedFillOrigoY(numCutplanes+1),
projectedFillDirection(numCutplanes+1),
projectedLinePen(numCutplanes+1), projectedLineType(numCutplanes+1)
PUT expression [, expression, ...]
PYRAMID n, h, mask, x1, y1, s1, ..., xn, yn, sn

```

R

```

RADIUS radius_min, radius_max
RECT a, b
RECT2 x1, y1, x2, y2
REF COMPONENT code [, keycode [, numeric_expression]]
REF DESCRIPTOR code [, keycode]
REMOVEKEY (dictionary.key)

```

```
REPEAT [statement1
      statement2
      ...
      statementn]
UNTIL condition

REQ (parameter_string)

REQUEST (question_name, name | index, variable1 [, variable2, ...])

RESOL n

RETURN

CALL macro_name_string [,]
      PARAMETERS [ALL][name1=value1, ..., namen=valuen][[,]
      RETURNED_PARAMETERS r1, r2, ...]

REVOLVE n, alpha, mask, x1, y1, s1, ..., xn, yn, sn

REVOLVEDSHELL topMat, bottomMat, sideMat_1, sideMat_2, sideMat_3, sideMat_4,
      defaultMat,
      n, offset, thickness, flipped, trimmingBody, alphaOffset, alpha,
      preThickenTran_11, preThickenTran_12, preThickenTran_13, preThickenTran_14,
      preThickenTran_21, preThickenTran_22, preThickenTran_23, preThickenTran_24,
      preThickenTran_31, preThickenTran_32, preThickenTran_33, preThickenTran_34,
      x_1, y_1, s_1,
      ...
      x_n, y_n, s_n

REVOLVEDSHELLANGULAR topMat, bottomMat,
      sideMat_1, sideMat_2, sideMat_3, sideMat_4, defaultMat,
      n, offset, thickness, flipped, trimmingBody, alphaOffset, alpha,
      segmentationType, nOfSegments,
      preThickenTran_11, preThickenTran_12, preThickenTran_13,
      preThickenTran_14,
      preThickenTran_21, preThickenTran_22, preThickenTran_23,
```

```
preThickenTran_24,  
preThickenTran_31, preThickenTran_32, preThickenTran_33,  
preThickenTran_34,  
x_1, y_1, s_1,  
...  
x_n, y_n, s_n  
REVOLVEDSHELLANGULAR{2} topMat, bottomMat,  
sideMat_1, sideMat_2, sideMat_3, sideMat_4, defaultMat,  
n, status, offset, thickness, flipped, trimmingBody, alphaOffset, alpha,  
segmentationType, nOfSegments,  
preThickenTran_11, preThickenTran_12, preThickenTran_13,  
preThickenTran_14,  
preThickenTran_21, preThickenTran_22, preThickenTran_23,  
preThickenTran_24,  
preThickenTran_31, preThickenTran_32, preThickenTran_33,  
preThickenTran_34,  
x_1, y_1, s_1,  
...  
x_n, y_n, s_n  
REVOLVEDSHELLANGULAR{3} topMat, bottomMat,  
sideMat_1, sideMat_2, sideMat_3, sideMat_4, defaultMat,  
n, status, offset, thickness, flipped, trimmingBody, alphaOffset, alpha,  
segmentationType, nOfSegments,  
preThickenTran_11, preThickenTran_12, preThickenTran_13,  
preThickenTran_14,  
preThickenTran_21, preThickenTran_22, preThickenTran_23,  
preThickenTran_24,  
preThickenTran_31, preThickenTran_32, preThickenTran_33,  
preThickenTran_34,  
x_1, y_1, s_1,  
...  
x_n, y_n, s_n
```

```

REVOLVEDSHELL{2} topMat, bottomMat, sideMat_1, sideMat_2, sideMat_3, sideMat_4,
    defaultMat,
    n, status, offset, thickness, flipped, trimmingBody, alphaOffset, alpha,
    preThickenTran_11, preThickenTran_12, preThickenTran_13, preThickenTran_14,
    preThickenTran_21, preThickenTran_22, preThickenTran_23, preThickenTran_24,
    preThickenTran_31, preThickenTran_32, preThickenTran_33, preThickenTran_34,
    x_1, y_1, s_1,
    ...
    x_n, y_n, s_n
REVOLVEDSHELL{3} topMat, bottomMat, sideMat_1, sideMat_2, sideMat_3, sideMat_4,
    defaultMat,
    n, status, offset, thickness, flipped, trimmingBody, alphaOffset, alpha,
    preThickenTran_11, preThickenTran_12, preThickenTran_13, preThickenTran_14,
    preThickenTran_21, preThickenTran_22, preThickenTran_23, preThickenTran_24,
    preThickenTran_31, preThickenTran_32, preThickenTran_33, preThickenTran_34,
    x_1, y_1, s_1,
    ...
    x_n, y_n, s_n
REVOLVE{2} n, alphaOffset, alpha, mask, sideMat,
    x1, y1, s1, mat1, ..., xn, yn, sn, matn
REVOLVE{3} n, alphaOffset, alpha, betaOffset, beta, mask, sideMat,
    x1, y1, s1, mat1, ..., xn, yn, sn, matn
REVOLVE{4} n, alphaOffset, alpha, betaOffset, beta, mask, sideMat,
    x1, y1, s1, mat1, ..., xn, yn, sn, matn
REVOLVE{5}n, alphaOffset, alpha, betaOffset, beta, mask, sideMat,
    x1, y1, s1, mat1, ..., xn, yn, sn, matn
RICHTEXT x, y,
    height, 0, textblock_name
RICHTEXT2 x, y, textblock_name

```

RND (x)

ROT x, y, z, alpha

ROT2 alpha

ROTX alphax

ROTY alphay

ROTZ alphaz

ROUND_INT (x)

RULED n, mask,
 u1, v1, s1, ..., un, vn, sn,
 x1, y1, z1, ..., xn, yn, zn

RULEDSEGMENTED n, mask,
 x11, y11, z11, s1, ..., x1n, y1n, z1n, sn,
 x21, y21, z21, ..., x2n, y2n, z2n

RULEDSEGMENTED{2} top_material, bottom_material,
 n, mask, textureMode,
 x11, y11, z11, s1, mat1..., x1n, y1n, z1n, sn, matn,
 x21, y21, z21, ..., x2n, y2n, z2n

RULEDSHELL topMat, bottomMat,
 sideMat_1, sideMat_2, sideMat_3, sideMat_4, defaultMat,
 n, m, g,
 offset, thickness, flipped, trimmingBody,
 preThickenTran_11, preThickenTran_12, preThickenTran_13, preThickenTran_14,
 preThickenTran_21, preThickenTran_22, preThickenTran_23, preThickenTran_24,
 preThickenTran_31, preThickenTran_32, preThickenTran_33, preThickenTran_34,
 firstpolyX_1, firstpolyY_1, firstpolyS_1,
 ...
 firstpolyX_n, firstpolyY_n, firstpolyS_n,
 secondpolyX_1, secondpolyY_1, secondpolyS_1,

```

...
secondpolyX_m, secondpolyY_m, secondpolyS_m,
profile2Tran_11, profile2Tran_12, profile2Tran_13, profile2Tran_14
profile2Tran_21, profile2Tran_22, profile2Tran_23, profile2Tran_24
profile2Tran_31, profile2Tran_32, profile2Tran_33, profile2Tran_34
generatrixFirstIndex_1, generatrixSecondIndex_1,
...
generatrixFirstIndex_g, generatrixSecondIndex_g
RULEDSHELL{2} topMat, bottomMat,
sideMat_1, sideMat_2, sideMat_3, sideMat_4, defaultMat,
n, m, g, status,
offset, thickness, flipped, trimmingBody,
preThickenTran_11, preThickenTran_12, preThickenTran_13, preThickenTran_14,
preThickenTran_21, preThickenTran_22, preThickenTran_23, preThickenTran_24,
preThickenTran_31, preThickenTran_32, preThickenTran_33, preThickenTran_34,
firstpolyX_1, firstpolyY_1, firstpolyS_1,
...
firstpolyX_n, firstpolyY_n, firstpolyS_n,
secondpolyX_1, secondpolyY_1, secondpolyS_1,
...
secondpolyX_m, secondpolyY_m, secondpolyS_m,
profile2Tran_11, profile2Tran_12, profile2Tran_13, profile2Tran_14
profile2Tran_21, profile2Tran_22, profile2Tran_23, profile2Tran_24
profile2Tran_31, profile2Tran_32, profile2Tran_33, profile2Tran_34
generatrixFirstIndex_1, generatrixSecondIndex_1,
...
generatrixFirstIndex_g, generatrixSecondIndex_g
RULEDSHELL{3} topMat, bottomMat,
sideMat_1, sideMat_2, sideMat_3, sideMat_4, defaultMat,
n, m, g, status,
offset, thickness, flipped, trimmingBody,
preThickenTran_11, preThickenTran_12, preThickenTran_13, preThickenTran_14,

```

```

preThickenTran_21, preThickenTran_22, preThickenTran_23, preThickenTran_24,
preThickenTran_31, preThickenTran_32, preThickenTran_33, preThickenTran_34,
firstpolyX_1, firstpolyY_1, firstpolyS_1,
...
firstpolyX_n, firstpolyY_n, firstpolyS_n,
secondpolyX_1, secondpolyY_1, secondpolyS_1,
...
secondpolyX_m, secondpolyY_m, secondpolyS_m,
profile2Tran_11, profile2Tran_12, profile2Tran_13, profile2Tran_14
profile2Tran_21, profile2Tran_22, profile2Tran_23, profile2Tran_24
profile2Tran_31, profile2Tran_32, profile2Tran_33, profile2Tran_34
generatrixFirstIndex_1, generatrixSecondIndex_1,
...
generatrixFirstIndex_g, generatrixSecondIndex_g

```

```

RULED{2} n, mask,
    u1, v1, s1, ..., un, vn, sn,
    x1, y1, z1, ..., xn, yn, zn

```

S

```

SECT_ATTRS fill, fill_background_pen,
    fill_pen, contour_pen [, line_type]
SECT_ATTRS{2} contour_pen [, line_type]
SECT_FILL fill, fill_background_pen,
    fill_pen, contour_pen
[SET] STYLE name_string
[SET] STYLE index
[SET] MATERIAL name_or_index
[SET] BUILDING_MATERIAL name_or_index
    [, cut_fill_pen [, cut_fill_bkgd_pen, [iOverrideFlag]]]

```

[SET] FILL name_string
[SET] FILL index
[SET] LINE_TYPE name_string
[SET] LINE_TYPE index
SETMIGRATIONGUID guid
SGN (x)
SHADOW casting [, catching]
SIN (x)
SLAB n, h, x1, y1, z1, ..., xn, yn, zn
SLAB_ n, h, x1, y1, z1, s1, ..., xn, yn, zn, sn
MODEL SOLID
SPHERE r
SPLINE2 n, status, x1, y1,
 angle1, ..., xn, yn, anglen
SPLINE2A n, status, x1, y1, angle1, length_previous1, length_next1,
 ...
 xn, yn, anglen, length_previousn,
 length_nextn
SPLIT (string, format, variable1 [, variable2, ..., variablen])
SPRISM_ top_material, bottom_material, side_material,
 n, xb, yb, xe, ye, h, angle,
 x1, y1, s1,
 ...
 xn, yn, sn
SPRISM_{2} top_material, bottom_material, side_material,
 n,

```

    xtb, ytb, xte, yte, topz, tangle,
    xbb, ybb, xbe, ybe, bottomz, bangle,
    x1, y1, s1, mat1,
    ...
    xn, yn, sn, matn
SPRISM_{3} top_material, bottom_material, side_material, mask,
    n,
    xtb, ytb, xte, yte, topz, tangle,
    xbb, ybb, xbe, ybe, bottomz, bangle,
    x1, y1, s1, mat1,
    ...
    xn, yn, sn, matn
SPRISM_{4} top_material, bottom_material, side_material, mask,
    n,
    xtb, ytb, xte, yte, topz, tangle,
    xbb, ybb, xbe, ybe, bottomz, bangle,
    x1, y1, s1, mat1,
    ...
    xn, yn, sn, matn
SQR (x)
FOR variable_name = initial_value TO end_value [ STEP step_value ] NEXT variable_name
STORED_PAR_VALUE ("oldparname", outputvalue)
STR (numeric_expression, length, fractions)
STR (format_string, numeric_expression)
STRLEN (string_expression)
STRSTR (string_expression1, string_expression2[, case_insensitivity])
STRSUB (string_expression, start_position, characters_number)
STRTOLOWER (string_expression)

```

STRTOUPPER (string_expression)
STR{2} (format_string, numeric_expression [, extra_accuracy_string])
STW (string_expression)
[SET] STYLE name_string
[SET] STYLE index
IND (STYLE, name_string)
SUBGROUP (g_expr1, g_expr2)
SUBGROUP{2} (g_expr1, g_expr2, edgeColor, materialId, materialColor [, operationStatus])
SUBGROUP{3} (g_expr1, g_expr2, edgeColor, materialId, materialColor [, operationStatus])
MODEL SURFACE
SURFACE3D ()
SWEEP n, m, alpha, scale, mask,
 u1, v1, s1, ..., un, vn, sn,
 x1, y1, z1, ..., xm, ym, zm
SWEEPGROUP (g_expr, x, y, z)
SWEEPGROUP{2} (g_expr, x, y, z)
SWEEPGROUP{3} (g_expr, x, y, z, edgeColor, materialId, materialColor, method)
SWEEPGROUP{4} (g_expr, x, y, z, edgeColor, materialId, materialColor, method, status)
SWEEPGROUP{5} (g_expr, x, y, z, edgeColor, materialId, materialColor, method, status)

T

TAN (x)
TEVE x, y, z, u, v
TEXT d, 0, expression

```
TEXT2 x, y, expression
TEXTBLOCK name width, anchor, angle, width_factor, charspace_factor, fixed_height,
    'string_expr1' [, 'string_expr2', ...]
TEXTBLOCK_name width, anchor, angle, width_factor, charspace_factor, fixed_height, n,
    'expr_1' [, 'expr_2', ..., 'expr_n']
IND (TEXTURE, name_string)
IF condition THEN label
IF condition GOTO label
IF condition GOSUB label
IF condition THEN statement [ELSE statement]
IF condition THEN
    [statement1
    statement2
    ...
    statementn]
[ELSE
    statementn+1
    statementn+2
    ...
    statementn+m]
ENDIF
FOR variable_name = initial_value TO end_value [ STEP step_value ] NEXT variable_name
TOLER d
DEL TOP
TUBE n, m, mask,
    u1, w1, s1,
    ...
    un, wn, sn,
```

```

        x1, y1, z1, angle1,
        ...
        xm, ym, zm, anglem
TUBE n, m, mask,
        u1, w1, s1,
        ...
        un, wn, sn,
        x1, y1, z1,
        ...
        xm, ym, zm
TUBE{2} top_material, bottom_material, cut_material,
        n, m, mask,
        u1, w1, s1, mat1,
        ...
        un, wn, sn, matn,
        x1, y1, z1, angle1,
        ...
        xm, ym, zm, anglem

```

U

```

UI_BUTTON type, text, x, y [, width, height, id [, url]]
UI_BUTTON type, text, x, y, width, height [, id [, url]] [ UI_TOOLTIP tooltiptext ]
UI_COLORPICKER "redParamName", "greenParamName", "blueParamName", x0, y0 [, width [, height]]
UI_COLORPICKER{2} redParamName, greenParamName, blueParamName, x0, y0 [, width [, height]]
UI_CURRENT_PAGE index
UI_CUSTOM_POPUP_INFIELD "name", x, y, width, height,
        storeHiddenId, treeDepth,
        groupingMethod, selectedValDescription,

```

```

    value1, value2, valuesArray1, .... valuen, valuesArrayn

UI_CUSTOM_POPUP_INFIELD "name", x, y, width, height , extra parameters ...
    [ UI_TOOLTIP tooltipText ]

UI_CUSTOM_POPUP_INFIELD{2} name, x, y, width, height,
    storeHiddenId, treeDepth,
    groupingMethod, selectedValDescription,
    value1, value2, valuesArray1, .... valuen, valuesArrayn

UI_CUSTOM_POPUP_INFIELD{2} name, x, y, width, height , extra parameters ...
    [ UI_TOOLTIP tooltipText ]

    UI_CUSTOM_POPUP_LISTITEM itemID, fieldID, "name", childFlag, image, paramDesc,
    storeHiddenId, treeDepth,
    groupingMethod, selectedValDescription,
    value1, value2, valuesArray1, .... valuen, valuesArrayn

UI_CUSTOM_POPUP_LISTITEM itemID, fieldID, "name", childFlag , image , paramDesc,
    extra parameters ...
    [ UI_TOOLTIP tooltipText ]

    UI_CUSTOM_POPUP_LISTITEM{2} itemID, fieldID, name, childFlag, image, paramDesc,
    storeHiddenId, treeDepth,
    groupingMethod, selectedValDescription,
    value1, value2, valuesArray1, .... valuen, valuesArrayn

UI_CUSTOM_POPUP_LISTITEM{2} itemID, fieldID, name, childFlag , image , paramDesc,
    extra parameters ...
    [ UI_TOOLTIP tooltipText ]

UI_DIALOG title [, size_x, size_y]

UI_GROUPBOX text, x, y, width, height

```

```
UI_INFIELD "name", x, y, width, height [,
    method, picture_name,
    images_number,
    rows_number, cell_x, cell_y,
    image_x, image_y,
    expression_imagel, textl,
    ...
    expression_imagen, textn]

UI_INFIELD "name", x, y, width, height [, extra parameters ... ]
    [ UI_TOOLTIP tooltipstext ]

UI_INFIELD{2} name, x, y, width, height [,
    method, picture_name,
    images_number,
    rows_number, cell_x, cell_y,
    image_x, image_y,
    expression_imagel, textl,
    ...
    expression_imagen, textn]

UI_INFIELD{2} name, x, y, width, height [, extra parameters ... ]
    [ UI_TOOLTIP tooltipstext ]

UI_INFIELD{3} name, x, y, width, height [,
    method, picture_name,
    images_number,
    rows_number, cell_x, cell_y,
    image_x, image_y,
    expression_imagel, textl, value_definitionl,
    ...
    [picIdxArray, textArray, valuesArray,
    ...]
    expression_imagen, textn, value_definitionn]
```

```

UI_INFIELD{3} name, x, y, width, height [, extra parameters ... ]
    [ UI_TOOLTIP tooltiptext ]

UI_INFIELD{4} "name", x, y, width, height [,
    method, picture_name,
    images_number,
    rows_number, cell_x, cell_y,
    image_x, image_y,
    expression_image1, text1, value_definition1,
    ...
    [picIdxArray, textArray, valuesArray,
    ...]
    expression_imagen, textn, value_definitionn]

UI_INFIELD{4} "name", x, y, width, height [, extra parameters ... ]
    [ UI_TOOLTIP tooltiptext ]

UI_LISTFIELD fieldID, x, y, width, height [, iconFlag [, description_header [,
    value_header]]]

UI_LISTFIELD fieldID, x, y, width, height [, iconFlag [, description_header [,
    value_header]]]
    [ UI_TOOLTIP tooltiptext ]

UI_LISTITEM itemID, fieldID, "name" [, childFlag [, image [, paramDesc]]]

UI_LISTITEM itemID, fieldID, "name" [, childFlag [, image [, paramDesc]]]
    [ UI_TOOLTIP tooltiptext ]

UI_LISTITEM{2} itemID, fieldID, name [, childFlag [, image [, paramDesc]]]

UI_LISTITEM{2} itemID, fieldID, name [, childFlag [, image [, paramDesc]]]
    [ UI_TOOLTIP tooltiptext ]

UI_OUTFIELD expression, x, y [, width, height [, flags]]

UI_OUTFIELD expression, x, y, width, height [, flags] [ UI_TOOLTIP tooltiptext ]

UI_PAGE page_number [, parent_id, page_title [, image]]

```

UI_PICT picture_reference, x, y [, width, height [, mask]]

UI_PICT expression, x, y [, width, height [, mask]] [UI_TOOLTIP tooltip]

UI_PICT_BUTTON type, text, picture_reference,
x, y, width, height [, id [, url]]

UI_PICT_BUTTON type, text, picture_reference,
x, y, width, height [, id [, url]] [UI_TOOLTIP tooltip]

UI_PICT_PUSHCHECKBUTTON name, text, picture_reference,
frameFlag, x, y, width, height [UI_TOOLTIP tooltip]

UI_PICT_PUSHCHECKBUTTON{2} "name", text, picture_reference,
frameFlag, x, y, width, height [UI_TOOLTIP tooltip]

UI_PICT_RADIOBUTTON name, value, text,
picture_reference, x, y, width, height [UI_TOOLTIP tooltip]

UI_PICT_RADIOBUTTON{2} "name", value, text,
picture_reference, x, y, width, height [UI_TOOLTIP tooltip]

UI_RADIOBUTTON name, value, text, x, y, width, height

UI_RADIOBUTTON name, value, text, x, y, width, height [UI_TOOLTIP tooltip]

UI_RADIOBUTTON{2} "name", value, text, x, y, width, height

UI_SEPARATOR x1, y1, x2, y2

UI_SLIDER "name", x0, y0, width, height [, nSegments [, sliderStyle]]

UI_SLIDER{2} name, x0, y0, width, height [, nSegments [, sliderStyle]]

UI_STYLE fontsize, face_code

UI_TEXTSTYLE_INFIELD name, faceCodeMask, x, y,
buttonWidth, buttonHeight[, buttonOffsetX]

UI_TEXTSTYLE_INFIELD{2} "name", faceCodeMask, x, y,
buttonWidth, buttonHeight [, buttonOffsetX]

UI_BUTTON type, text, x, y, width, height [, id [, url]] [UI_TOOLTIP tooltipText]

UI_PICT_BUTTON type, text, picture_reference,
x, y, width, height [, id [, url]] [UI_TOOLTIP tooltipText]

UI_INFIELD "name", x, y, width, height [, extra parameters ...]
[UI_TOOLTIP tooltipText]

UI_INFIELD{2} name, x, y, width, height [, extra parameters ...]
[UI_TOOLTIP tooltipText]

UI_INFIELD{3} name, x, y, width, height [, extra parameters ...]
[UI_TOOLTIP tooltipText]

UI_INFIELD{4} "name", x, y, width, height [, extra parameters ...]
[UI_TOOLTIP tooltipText]

UI_CUSTOM_POPUP_INFIELD "name", x, y, width, height , extra parameters ...
[UI_TOOLTIP tooltipText]

UI_CUSTOM_POPUP_INFIELD{2} name, x, y, width, height , extra parameters ...
[UI_TOOLTIP tooltipText]

UI_RADIOBUTTON name, value, text, x, y, width, height [UI_TOOLTIP tooltipText]

UI_OUTFIELD expression, x, y, width, height [, flags] [UI_TOOLTIP tooltipText]

UI_PICT expression, x, y [, width, height [, mask]] [UI_TOOLTIP tooltipText]

UI_LISTFIELD fieldID, x, y, width, height [, iconFlag [, description_header [, value_header]]]
[UI_TOOLTIP tooltipText]

UI_LISTITEM itemID, fieldID, "name" [, childFlag [, image [, paramDesc]]]
[UI_TOOLTIP tooltipText]

UI_LISTITEM{2} itemID, fieldID, name [, childFlag [, image [, paramDesc]]]
[UI_TOOLTIP tooltipText]

UI_CUSTOM_POPUP_LISTITEM itemID, fieldID, "name", childFlag , image , paramDesc,
extra parameters ...

```

        [ UI_TOOLTIP tooltipText ]
UI_CUSTOM_POPUP_LISTITEM{2} itemID, fieldID, name, childFlag , image , paramDesc,
    extra parameters ...
        [ UI_TOOLTIP tooltipText ]
REPEAT [statement1
    statement2
    ...
    statementn]
UNTIL condition
USE (n)

```

V

```

VALUES "parameter_name" [,]value_definition1 [, value_definition2, ...]
VALUES "fill_parameter_name" [[,] FILLTYPES_MASK fill_types], value_definition1
    [, value_definition2, ...]
VALUES "profile_parameter_name" [[,] PROFILETYPES_MASK profile_types], value_definition1
    [, value_definition2, ...]
VALUES{2} "parameter_name" [,]num_expression1, description1,
    [, num_expression2, description2, ...]
VALUES{2} "parameter_name" [,]num_values_array1, descriptions_array1
    [, num_values_array2, descriptions_array2, ...]
VARDIM1 (expr)
VARDIM2 (expr)
VARTYPE (expression)
VECT x, y, z
VERT x, y, z
VERT x, y, z, hard

```

VOLUME3D ()

W

WALLARC2 x, y, r, alpha, beta

WALLBLOCK2 n, fill_control, fill_pen, fill_background_pen,
fillOrigoX, fillOrigoY, fillAngle,
x1, y1, s1,
...
xn, yn, sn

WALLBLOCK2{2} n, frame_fill, fillcategory, distortion_flags,
fill_pen, fill_background_pen,
fillOrigoX, fillOrigoY,
mxx, mxy, myx, myy,
innerRadius,
x1, y1, s1,
...
xn, yn, sn

WALLHOLE n, status,
x1, y1, mask1,
...
xn, yn, maskn
[, x, y, z]

WALLHOLE2 n, fill_control, fill_pen, fill_background_pen,
fillOrigoX, fillOrigoY, fillAngle,
x1, y1, s1,
...
xn, yn, sn

WALLHOLE2{2} n, frame_fill, fillcategory, distortion_flags,
fill_pen, fill_background_pen,
fillOrigoX, fillOrigoY,

```

        mxx, mxy, myx, myy,
        innerRadius,
        x1, y1, s1,
        ...
        xn, yn, sn
WALLLINE2 x1, y1, x2, y2
WALLNICHE n, method, status,
        rx, ry, rz, d,
        x1, y1, mask1, [mat1,]
        ...
        xn, yn, maskn[, matn]
DO [statement1
    statement2
    ...
    statementn]
WHILE condition
WHILE condition DO
    [statement1
    statement2
    ...
    statementn]
ENDWHILE
MODEL WIRE

```

X

```

XFORM newx_x, newy_x, newz_x, offset_x,
        newx_y, newy_y, newz_y, offset_y,
        newx_z, newy_z, newz_z, offset_z
XWALL_ left_material, right_material, vertical_material, horizontal_material,

```

```
height, x1, x2, x3, x4,
y1, y2, y3, y4,
t, radius,
log_height, log_offset,
mask1, mask2, mask3, mask4,
n,
x_start1, y_low1, x_end1, y_high1,
frame_shown1,
...
x_startn, y_lown, x_endn, y_highn,
frame_shownn,
m,
a1, b1, c1, d1,
...
am, bm, cm, dm,
status

XWALL_{2} left_material, right_material, vertical_material, horizontal_material,
height, x1, x2, x3, x4,
y1, y2, y3, y4,
t, radius,
log_height, log_offset,
mask1, mask2, mask3, mask4,
n,
x_start1, y_low1, x_end1, y_high1,
sill_depth1, frame_shown1,
...
x_startn, y_lown, x_endn, y_highn,
sill_depthn, frame_shownn,
m,
a1, b1, c1, d1,
...
am, bm, cm, dm,
```

```
    status
XWALL_{3} left_material, right_material, vertical_material, horizontal_material,
    height, x1, x2, x3, x4,
    y1, y2, y3, y4,
    t, radius,
    log_height, log_offset,
    mask1, mask2, mask3, mask4,
    n,
    x_start1, y_low1, x_end1, y_high1,
    sill_depth1, frame_shown1,
    ...
    x_startn, y_lown, x_endn, y_highn,
    sill_depthn, frame_shownn,
    m,
    a1, b1, c1, d1,
    ...
    am, bm, cm, dm,
    status
```